

Power Panel 65

User's manual

Version: **2.30 (January 2020)**
Order no.: **MAPP65-ENG**

Translation of the original documentation

All values in this manual are current as of its creation. We reserve the right to change the contents of this manual without notice. B&R Industrial Automation GmbH is not liable for technical or editorial errors and defects in this manual. In addition, B&R Industrial Automation GmbH assumes no liability for damages that are directly or indirectly attributable to the delivery, performance or use of this material. We point out that the software and hardware designations and brand names of the respective companies used in this document are subject to general trademark, brand or patent protection.

Chapter 1 General information.....	7
1 Manual history.....	7
2 General safety guidelines.....	8
2.1 Introduction.....	8
2.2 Intended use.....	8
2.3 Protection against electrostatic discharge.....	8
2.4 Transport and storage.....	9
2.5 Installation.....	9
2.6 Operation.....	9
2.7 Cybersecurity disclaimer for products.....	11
3 Terminology.....	12
Chapter 2 Device description.....	13
1 System features.....	13
1.1 Compact solution.....	13
1.2 Simple programming.....	13
1.3 Perfect for multi-axis applications.....	13
1.4 Display and interfaces provide maximum flexibility.....	13
1.5 General technical data.....	14
1.6 Overview.....	15
2 Topologies.....	16
2.1 Power Panel as intelligent HMI, networked with X2X Link and CAN.....	16
2.2 Power Panel as intelligent HMI, networked with POWERLINK.....	17
3 System overview.....	18
4 4PP065.0351-P74.....	19
4.1 Order data.....	19
4.2 Technical data.....	19
4.3 Supported interface modules.....	21
4.4 Diagnostic LEDs.....	22
4.5 Connection elements.....	24
4.6 Key assignments.....	26
4.7 Operating mode and node number switches.....	26
4.8 Dimensions.....	27
5 4PP065.0351-X74.....	28
5.1 Order data.....	28
5.2 Technical data.....	28
5.3 Supported interface modules.....	30
5.4 Diagnostic LEDs.....	31
5.5 Connection elements.....	32
5.6 Key assignments.....	33
5.7 Operating mode and node number switches.....	34
5.8 Dimensions.....	35
6 4PP065.0571-P74.....	36
6.1 Order data.....	36
6.2 Technical data.....	36
6.3 Supported interface modules.....	38
6.4 Diagnostic LEDs.....	38
6.5 Connection elements.....	41
6.6 Operating mode and node number switches.....	43
6.7 Dimensions.....	44
7 4PP065.0571-X74.....	45
7.1 Order data.....	45
7.2 Technical data.....	45
7.3 Supported interface modules.....	47
7.4 Diagnostic LEDs.....	48
7.5 Connection elements.....	49
7.6 Operating mode and node number switches.....	50

7.7 Dimensions.....	51
8 4PP065.0571-P74F.....	52
8.1 Order data.....	52
8.2 Technical data.....	52
8.3 Supported interface modules.....	54
8.4 Diagnostic LEDs.....	55
8.5 Connection elements.....	57
8.6 Key assignments.....	59
8.7 Operating mode and node number switches.....	59
8.8 Dimensions.....	60
9 4PP065.0571-X74F.....	61
9.1 Order data.....	61
9.2 Technical data.....	61
9.3 Supported interface modules.....	63
9.4 Diagnostic LEDs.....	64
9.5 Connection elements.....	65
9.6 Key assignments.....	66
9.7 Operating mode and node number switches.....	67
9.8 Dimensions.....	68

Chapter 3 Interface modules.....69

1 General information.....	69
2 Overview.....	69
3 Power Panel 65 support.....	69
4 4PP065.IF10-1.....	70
4.1 Order data.....	70
4.2 Technical data.....	70
4.3 LED status indicators.....	71
4.4 RS232 interface.....	71
5 4PP065.IF23-1.....	72
5.1 Order data.....	72
5.2 Technical data.....	72
5.3 LED status indicators.....	73
5.4 CAN bus node number.....	73
5.5 RS232 (IF1) or RS485/RS422 (IF2) interface.....	74
5.6 CAN bus interface (IF3).....	74
5.7 Terminating resistors.....	74
5.8 I/O mapping in Automation Studio.....	75
6 4PP065.IF24-1.....	76
6.1 Order data.....	76
6.2 Technical data.....	76
6.3 LED status indicators.....	77
6.4 PROFIBUS DP slave node number.....	77
6.5 RS232 (IF1) or RS485/RS422 (IF2) interface.....	78
6.6 PROFIBUS DP slave interface (IF3).....	78
6.7 Terminating resistors.....	78
6.8 I/O mapping in Automation Studio.....	79
7 4PP065.IF33-1.....	80
7.1 Order data.....	80
7.2 Technical data.....	80
7.3 LED status indicators.....	81
7.4 CAN bus node number.....	81
7.5 CAN bus interface (IF1 and IF2).....	81
7.6 Terminating resistors.....	82
7.7 I/O mapping in Automation Studio.....	82

Chapter 4 Commissioning.....	83
1 Installation cutout requirements.....	83
2 Installation instructions.....	83
3 Mounting orientations.....	85
4 Installing interface modules.....	85
5 Touch screen calibration.....	86
6 Screen rotation.....	86
Chapter 5 Standards and certifications.....	87
1 Applicable European directives.....	87
2 Overview of standards.....	87
3 Emission requirements.....	88
3.1 Network-related emissions.....	88
3.2 Emissions, electromagnetic emissions.....	88
4 Requirements for immunity to disturbances.....	89
4.1 Electrostatic discharge (ESD).....	89
4.2 High-frequency electromagnetic fields (HF field).....	89
4.3 High-speed transient electrical disturbances (Burst).....	90
4.4 Surge voltages (Surge).....	90
4.5 Conducted disturbances.....	90
4.6 Magnetic fields with electrical frequencies.....	90
4.7 Voltage dips, fluctuations, and short-term interruptions.....	90
4.8 Damped vibration.....	91
5 Mechanical conditions.....	91
5.1 Vibration operation.....	91
5.2 Vibration during transport (packaged).....	91
5.3 Shock during operation.....	91
5.4 Shock during transport (packaged).....	91
5.5 Toppling.....	91
5.6 Free fall (packaged).....	92
6 Climate conditions.....	92
6.1 Worst case operation.....	92
6.2 Dry heat.....	92
6.3 Dry cold.....	92
6.4 Large temperature fluctuations.....	92
6.5 Temperature fluctuations in operation.....	93
6.6 Humid heat, cyclic.....	93
6.7 Constant humid heat (storage).....	93
6.8 Sprayed water (front side).....	93
7 Safety.....	94
7.1 Ground resistance.....	94
7.2 Insulation resistance.....	94
7.3 High voltage.....	94
7.4 Voltage range.....	94
8 Other tests.....	95
8.1 Protection.....	95
9 International certifications.....	95
Chapter 6 Accessories.....	97
1 Overview.....	97
2 Replacement batteries.....	98
2.1 Order data.....	98
2.2 Technical data.....	98
2.3 Contents of delivery.....	98
3 TB103 3-pin power supply connector.....	99
3.1 Order data.....	99
3.2 Technical data.....	99

3.3 Contents of delivery.....	100
4 TB704 4-pin X2X Link connector.....	101
4.1 Order data.....	101
4.2 Technical data.....	101
4.3 Contents of delivery.....	101
5 Slide-in label templates.....	102
6 Data storage media.....	102
Chapter 7 Maintenance.....	103
1 Cleaning.....	103
2 Replacing the battery.....	104
2.1 General information.....	104
2.2 Evaluating the battery status.....	104
2.3 Technical data.....	104
2.4 Procedure for replacing the battery.....	104
3 Replacing the CompactFlash card.....	106
3.1 Removing the CompactFlash card.....	106
3.2 Inserting the CompactFlash card.....	107
4 Preventing screen burn-in on LCD/TFT displays.....	108
4.1 How can this be avoided?.....	108
Chapter 8 Environmentally friendly disposal.....	109
1 Separation of materials.....	109
Chapter 9 Abbreviations.....	111
1 General information.....	111
2 Overview.....	111

Chapter 1 • General information

Information:

B&R makes every effort to keep user's manuals as current as possible. The most current versions can be downloaded from the B&R website www.br-automation.com.

1 Manual history

Version	Date	Comment
2.30	January 2020	Updated the following sections: <ul style="list-style-type: none"> • See section "Device description" on page 13 for the technical data of the main devices, "Interface modules" on page 69 for interface modules and "Accessories" on page 97 for accessories. • "General information" on page 7 • "Cleaning" on page 103 • "General technical data" on page 14 Updated the following sections: <ul style="list-style-type: none"> • "Temperature monitoring" on page 14 • "Installation cutout requirements" on page 83 • "Environmentally friendly disposal" on page 109
2.21	December 2016	The following changes were made: <ul style="list-style-type: none"> • Added I/O mapping to chapter "Interface modules". • Updated technical data (detailed specifications for certifications). • Editorial corrections.
2.20	April 2016	Updated chapters "Power Panel" and "Interface modules".
2.10	October 2014	Updated chapter "Accessories".
2.00	February 2014	Updated the following chapters: <ul style="list-style-type: none"> • Technical data in chapter 2 "Power Panel 65" • Technical data in chapter 3 "PP65 interface modules" • Chapter 5 "Standards and certifications" • Chapter 6 "Accessories"
1.00	May 2011	First edition.

2 General safety guidelines

Notice!

If the device is not used in accordance with the manufacturer's instructions, the protection provided by the device may be impaired.

2.1 Introduction

Programmable logic controllers (PLCs), operating and monitoring devices (such as industrial PCs, Power Panels, Mobile Panels, etc.) as well as the uninterruptible power supply from B&R have been designed, developed and manufactured for normal use in industry. They have not been designed, developed and manufactured for use that involves fatal risks or hazards that could result in death, injury, serious physical harm or other loss without the assurance of exceptionally stringent safety precautions. In particular, this includes the use of these systems to monitor nuclear reactions in nuclear power plants, flight control systems, air traffic control, the control of mass transport vehicles, medical life support systems and the control of weapon systems.

When using programmable logic controllers as well as when using operating and monitoring devices as control systems in conjunction with a Soft PLC (e.g. Automation Runtime or similar product) or Slot PLC (e.g. B&R LS251 or similar product), the safety measures that apply to industrial controllers (protection by protective equipment such as emergency stops, etc.) must be observed in accordance with applicable national and international regulations. This also applies to all other connected devices, such as drives.

All work such as installation, commissioning and servicing are only permitted to be carried out by qualified personnel. Qualified personnel are persons who are familiar with the transport, installation, assembly, commissioning and operation of the product and have the appropriate qualifications for their job (e.g. IEC 60364). National accident prevention regulations must be observed.

The safety guidelines, information about connection conditions (nameplate and documentation) and limit values specified in the technical data must be read carefully before installation and commissioning and must be strictly observed.

2.2 Intended use

Electronic devices are generally not failsafe. If the programmable logic controller, operating or monitoring device or uninterruptible power supply fails, the user is responsible for ensuring that connected devices, such as motors, are brought to a safe state.

2.3 Protection against electrostatic discharge

Electrical assemblies that can be damaged by electrostatic discharge (ESD) must be handled accordingly.

2.3.1 Packaging

- Electrical assemblies with housing do not require special ESD packaging but must be handled properly (see "[Electrical assemblies with housing](#)" on page 8).
- Electrical assemblies without housing are protected by ESD-suitable packaging.

2.3.2 Regulations for proper ESD handling

Electrical assemblies with housing

- Do not touch the connector contacts on the device (bus data contacts).
- Do not touch the connector contacts of connected cables.
- Do not touch the contact tips on circuit boards.

Electrical assemblies without housing

The following applies in addition to "Electrical assemblies with housing":

- All persons handling electrical assemblies and devices in which electrical assemblies are installed must be grounded.
- Assemblies are only permitted to be touched on the narrow sides or front plate.
- Always place assemblies on suitable surfaces (ESD packaging, conductive foam, etc.).

Information: Metallic surfaces are not suitable surfaces!

- Assemblies must not be subjected to electrostatic discharges (e.g. due to charged plastics).
- A minimum distance of 10 cm from monitors or television sets must be maintained.
- Measuring instruments and devices must be grounded.
- Test probes of floating potential measuring instruments must be discharged briefly on suitable grounded surfaces before measurement.

Individual components

- ESD protective measures for individual components are implemented throughout B&R (conductive floors, shoes, wrist straps, etc.).
- The increased ESD protective measures for individual components are not required for handling B&R products at customer locations.

2.4 Transport and storage

During transport and storage, devices must be protected against undue stress (mechanical stress, temperature, humidity, aggressive atmosphere).

Devices contain components sensitive to electrostatic charges that can be damaged by improper handling. It is therefore necessary to provide the required protective measures against electrostatic discharge when installing or removing these devices (see "[Protection against electrostatic discharge](#)" on page 8).

2.5 Installation

- Installation must be performed according to this documentation using suitable equipment and tools.
- Devices are only permitted to be installed by qualified personnel when the power is switched off.
- General safety regulations and national accident prevention regulations must be observed.
- The electrical installation must be carried out in accordance with relevant regulations (e.g. wire cross section, fuse protection, protective ground connection).
- Take the necessary protective measures against electrostatic discharge (see "[Protection against electrostatic discharge](#)" on page 8).

2.6 Operation

2.6.1 Protection against contact with electrical parts

In order to operate programmable logic controllers, operating and monitoring devices and the uninterruptible power supply, it is necessary for certain components to carry dangerous voltages over 42 VDC. Touching one of these components can result in a life-threatening electric shock. There is a risk of death, serious injury or damage to property.

Before switching on the programmable logic controllers, operating and monitoring devices and uninterruptible power supply, it must be ensured that the housing is properly connected to ground potential (PE rail). The ground connection must also be made if the operating and monitoring device and uninterruptible power supply are only connected for testing purposes or only operated for a short time!

Before switching on, live parts must be securely covered. All covers must be kept closed during operation.

2.6.2 Ambient conditions - Dust, moisture, aggressive gases

The use of operating and monitoring devices (e.g. industrial PCs, Power Panels, Mobile Panels, etc.) and uninterruptible power supplies in dusty environments must be avoided. This can otherwise lead to dust deposits that affect the functionality of the device. Sufficient cooling may then no longer be ensured, especially in systems with an active cooling unit (fan).

The presence of aggressive gases in the environment can also result in malfunctions. In combination with high temperature and relative humidity, aggressive gases – for example with sulfur, nitrogen and chlorine components – trigger chemical processes that can very quickly impair or damage electronic components. Blackened copper surfaces and cable ends in existing installations are indicators of aggressive gases.

When operated in rooms with dust and condensation that can endanger functionality, operating and monitoring devices such as Automation Panels or Power Panels are protected on the front against the ingress of dust and moisture when installed correctly (e.g. cutout installation). The back of all devices must be protected against the ingress of dust and moisture, however, or the dust deposits must be removed at suitable intervals.

2.6.3 Programs, viruses and malicious programs

Any data exchange or installation of software using data storage media (e.g. floppy disk, CD-ROM, USB flash drive, etc.) or via networks or the Internet poses a potential threat to the system. It is the user's own responsibility to avert these dangers and to take appropriate measures such as virus protection programs, firewalls, etc. to protect against them and to use only software from trustworthy sources.

2.7 Cybersecurity disclaimer for products

B&R products communicate via a network interface and were developed for secure connection with internal and, if necessary, other networks such as the Internet.

Information:

In the following, B&R products are referred to as "product" and all types of networks (e.g. internal networks and the Internet) are referred to as "network".

It is the sole responsibility of the customer to establish and continuously ensure a secure connection between the product and the network. In addition, appropriate security measures must be implemented and maintained to protect the product and entire network from any security breaches, unauthorized access, interference, digital intrusion, data leakage and/or theft of data or information.

B&R Industrial Automation GmbH and its subsidiaries are not liable for damages and/or losses in connection with such security breaches, unauthorized access, interference, digital intrusion, data leakage and/or theft of data or information.

The aforementioned suitable security measures include, for example:

- Segmentation of the network (e.g. separation of the IT network from the control network¹⁾)
- Use of firewalls
- Use of authentication mechanisms
- Encryption of data
- Use of anti-malware software

Before B&R releases products or updates, they are subjected to appropriate functional testing. Independently of this, we recommend that our customers develop their own test processes in order to be able to check the effects of changes in advance. Such changes include, for example:

- Installation of product updates
- Significant system modifications such as configuration changes
- Import of updates or patches for third-party software (non-B&R software)
- Hardware replacement

These tests should ensure that implemented security measures remain effective and that systems in the customer's environment behave as expected.

¹⁾ The term "control network" refers to computer networks used to connect control systems. The control network can be divided into zones, and there can be several separate control networks within a company or site. The term "control systems" refers to all types of B&R products such as controllers (e.g. X20), HMI systems (e.g. Power Panel T30), process control systems (e.g. APROL) and supporting systems such as engineering workstations with Automation Studio.

3 Terminology

Term	Explanation
SG3	System Generation 3 (SG3) - CPUs with Motorola processors The following CPUs belong to this series: CP260, IF161, IP161, XP152, CP100, CP104, CP152, CP153, CP200, CP210, CP430, CP470, CP474, CP476, CP770, CP774, PP15, PP21, PP35, PP41
SG4	System Generation 4 (SG4) - CPUs with Intel processors The following CPUs belong to this series: CP1483, CP1484, CP1485-1, CP1486, CP3484, CP3485-1, CP3486, CP340, CP360, CP380, CP382, CP570, PP45, PP65, PP100/200, PP300/400, MP100/200, EC20, EC21, AC140, AC141, ARsim, ARwin, ARemb, APC620, APC700, APC810
SGC	System Generation Compact CPUs (SGC) - CPUs with Motorola processors (Embedded μ P) The following CPUs belong to this series: CP0201, CP0291, CP0292, XC0201, XC0202, XC0292

Table 1: Terminology

Chapter 2 • Device description

1 System features

The PP65 is an especially compact addition to the proven Power Panel product family. Modular fieldbus interfaces ensure flexible integration in all configurations.

Ethernet, POWERLINK and X2X Link are used for the communication system. Additionally, these devices have been equipped with a slot for interface modules. Depending on requirements, the Power Panel 65 can be expanded with CAN bus, a PROFIBUS DP slave or an RS485/RS232 interface, making it perfectly suited for demanding tasks. Customized panel overlay designs are also available.

- Cost-effective complete solution
- Compact dimensions
- Integrates controller, visualization and I/O interface

1.1 Compact solution

The PP65 is both a controller and an operator panel. Any necessary peripherals can be connected using the integrated X2X interface. Using the optional interface modules, it is also possible to connect other B&R products or even to integrate the PP65 into control systems from other manufacturers. All components are situated in a compact housing with a 3.5" or 5.7" QVGA TFT display.

1.2 Simple programming

Full integration of the HMI application into B&R's Automation Studio programming and diagnostic tool goes without saying. The same is true for programming in all of the IEC languages offered by B&R as well as Automation Basic and ANSI C.

1.3 Perfect for multi-axis applications

The PP65 is equipped with a powerful Geode LX800 processor with 500 MHz clock frequency. With this computing power, the PP65 provides performance that was previously only achieved by the PP400. The PP65 is therefore especially suitable for multi-axis applications that require lots of computing power but only have limited space in the control cabinet. The compact dimensions of the PP45 have been taken over in this case.

1.4 Display and interfaces provide maximum flexibility

The PP65 provides maximum flexibility with two different display types with identical installation dimensions: a 5.7" model with touch screen (and no function keys) and a 3.5" model with touch screen and 30 function keys.

Equipped with 2 USB interfaces and a Fast Ethernet port for exchanging data with higher level systems, the PP65 is also available with integrated X2X or POWERLINK interface options for connecting remote I/O modules and drives. These systems can be further extended with RS232/RS485, CAN and PROFIBUS DP slave interfaces to meet any requirement.

1.5 General technical data

Name	Description
CPU	Geode LX800 500 MHz CPU
Memory	128 MB SDRAM 232 kB SRAM, nonvolatile CompactFlash program memory
Interfaces	Ethernet 10/100 POWERLINK or X2X Link 2x USB 2.0
Slots	CompactFlash slot Expansion slot
Other	IP65 protection (on front) Temperature range from 0 to 50°C Fanless 24 VDC power supply
Dimensions	203x145x55 mm

1.5.1 Temperature monitoring

Monitoring by the application

The user can implement temperature monitoring or appropriate measures in the application if the temperature is exceeded.

Two data points are available for this purpose:

Data point	Description
TemperatureCPU	Temperature of the CPU housing
TemperatureENV	Inner temperature of the Power Panel

1.5.2 Surface resistance of the panel overlay

The panel overlay conforms to DIN 42115 (Part 2). This means it is resistant to exposure to the following chemicals for a 24-hour period with no visible signs of damage:

Ethanol Cyclohexanol Diacetone alcohol Glycol Isopropanol Glycerine Methanol Triacetin Dowandol DRM/PM	Formaldehyde 37%-42% Acetaldehyde Aliphatic hydrocarbons Toluene Xylene White spirits	Trichloroethane Ethyl acetate Diethyl ether n-Butyl acetate Amyl acetate Butylcellosolve Ether
Acetone Methyl ethyl ketone Dioxan Cyclohexanone Methylisobutylketone (MIBK) Isophorone	Formic acid < 50% Acetic acid < 50% Phosphoric acid < 30% Hydrochloric acid < 36% Nitric acid < 10% Trichloroacetic acid < 50% Sulphuric acid < 10%	Sodium chloride <20% Hydrogen peroxide < 25% Potassium carbonate Washing agents Tenside Fabric conditioner Iron (II) chloride Iron (III) chloride Dibutyl phthalate Diocetyl phthalate Sodium carbonate
Ammonia < 40% Caustic soda < 40% Potassium hydroxide Alkali carbonate Bichromate Potassium Acetonitrile Sodium bisulphate	Cutting oil Diesel oil Linseed oil Paraffin oil Ricinus oil Silicon oil Turpentine oil substitute Brake fluid Aviation fuel Gasoline Water Sea water Decon	

Information:

The specified characteristics, features and limit values only apply to this individual component and can deviate from those specified for the complete system.

Per DIN 42115 Part 2, the panel overlay is resistant to glacial acetic acid for less than one hour without visible damage.

1.5.3 Viewing angles

For the viewing angles values (U, D, R, L) of the display types, see the technical data of the respective device.

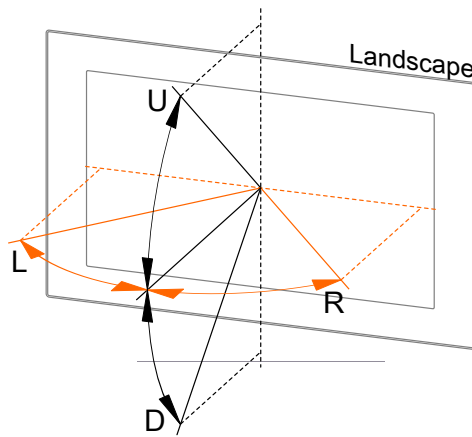

Legend	Display viewing angle
U	From top
D	From bottom
L	From left
R	From right

The viewing angles are specified for the horizontal (L, R) and vertical (U, D) axes in reference to the vertical axis of the display. The specified viewing angles above always refer to the standard mounting orientation of the respective Power Panel.

1.6 Overview

Model number	4PP065.0351-P74	4PP065.0351-X74	4PP065.0571-P74	4PP065.0571-X74	4PP065.0571-P74F	4PP065.0571-X74F
Figure						
Display	TFT color					
Resolution	QVGA					
Display size	3.5"			5.7"		
Touch screen	Analog resistive					
Keys	30		-		10	
Slot for interface modules	1					
Interfaces						
Ethernet 10/100	1					
POWERLINK	1	-	1	-	1	-
X2X Link	-	1	-	1	-	1
USB 2.0	2					
Page	19	28	36	45	52	61

2 Topologies

2.1 Power Panel as intelligent HMI, networked with X2X Link and CAN

In this topology, the control program and visualization application run on the Power Panel 65. I/O peripherals and drives are connected via CAN bus or X2X.

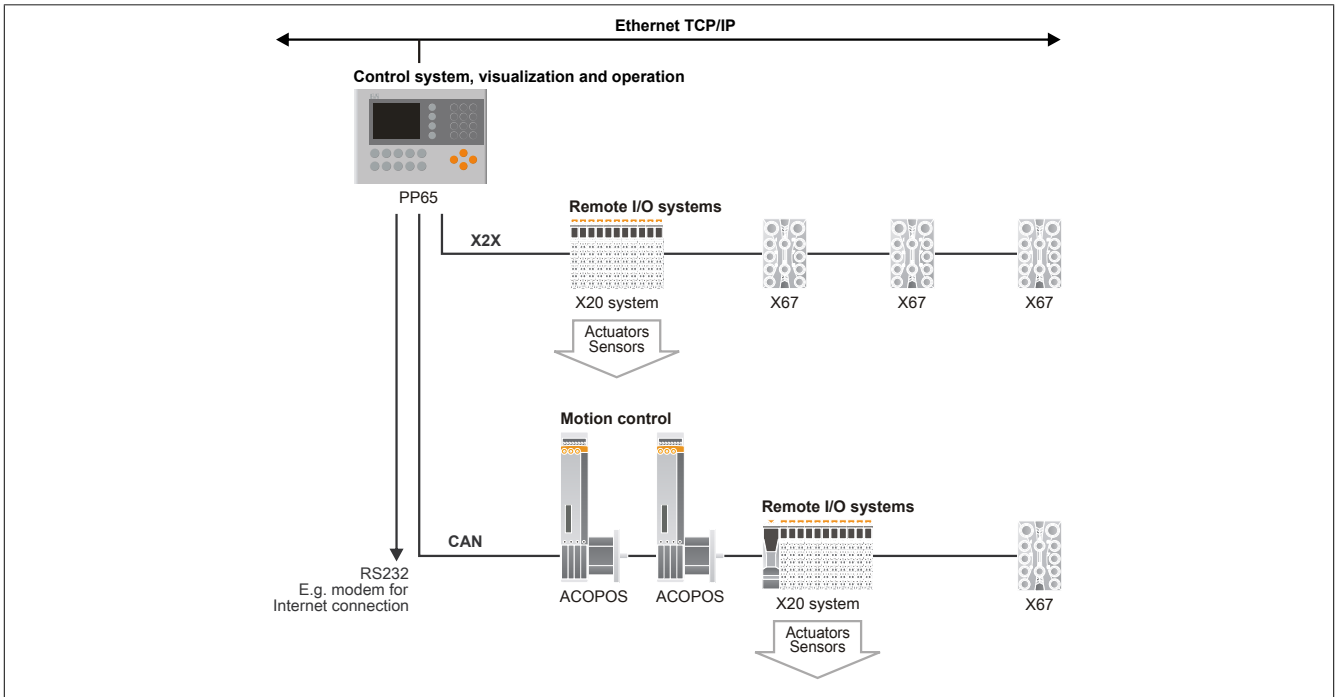

Components and technologies	
Control system	Power Panel 65
Visualization and operation	Power Panel 65
Motion control	ACOPOS: Intelligent servo drives ACOPOSmulti: Modular drive system
Remote I/O systems	X20 system: Slice-based I/O and control system X67 system: Remote I/O with IP67 protection

2.2 Power Panel as intelligent HMI, networked with POWERLINK

In this topology, the control program runs on the Power Panel 65. I/O peripherals and drives are connected to the Power Panel via POWERLINK.

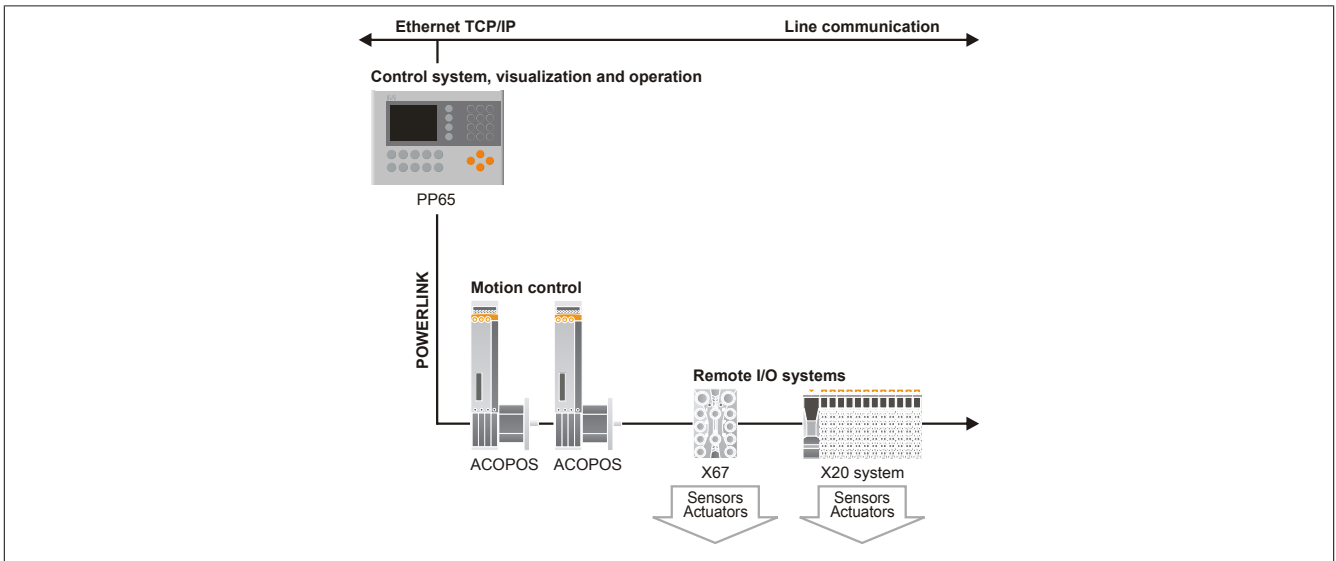

Components and technologies	
Control system	Power Panel 65
Visualization and operation	Power Panel 65
Motion control	ACOPOS: Intelligent servo drives ACOPOSmulti: Modular drive system
Remote I/O systems	X20 system: Slice-based I/O and control system X67 system: Remote I/O with IP67 protection

3 System overview

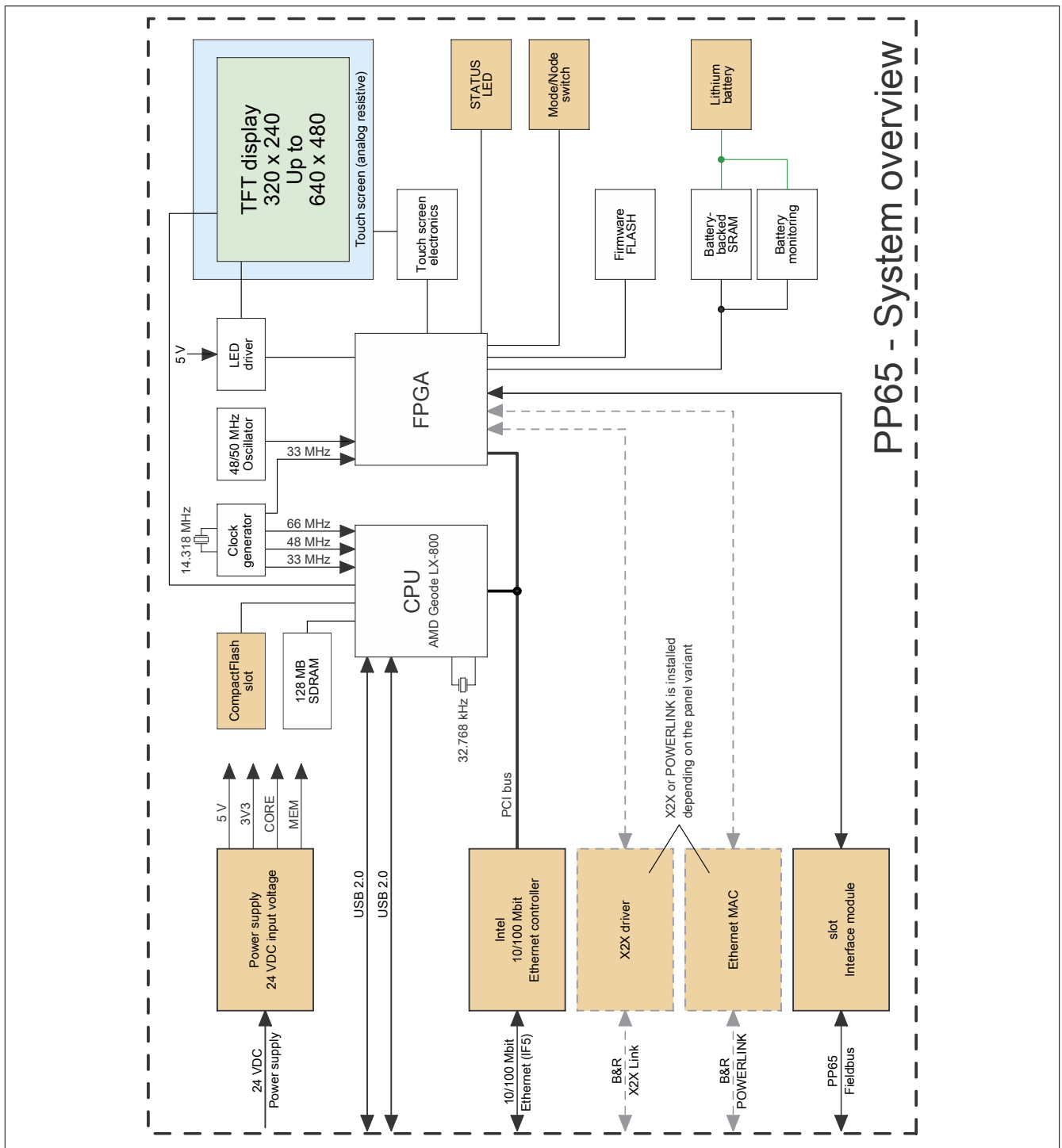

4 4PP065.0351-P74

4.1 Order data

Model number	Short description	Figure
	Power Panel 65	
4PP065.0351-P74	Power Panel PP65, 3.5" QVGA color TFT display with touch screen (resistive), 30 function keys, 128 MB DRAM, 232 kB SRAM, CompactFlash slot, 1x ETH 10/100, 1x POWERLINK, 2x USB, IP65 protection (front), order application memory separately Order 0TB103 terminal block separately	
	Required accessories	
	Accessories	
0TB103.9	Connector 24 VDC - 3-pin female - Screw clamp terminal block 3.31 mm ²	
0TB103.91	Connector 24 VDC - 3-pin, female - Cage clamp terminal block 3.31 mm ²	
	CompactFlash cards	
0CFCRD.0512E.01	CompactFlash 512 MB extended temp.	
0CFCRD.2048E.01	CompactFlash 2048 MB extended temp.	
5CFCRD.0512-06	CompactFlash 512 MB B&R (SLC)	
5CFCRD.1024-06	CompactFlash 1 GB B&R (SLC)	
5CFCRD.2048-06	CompactFlash 2 GB B&R (SLC)	
5CFCRD.4096-06	CompactFlash 4 GB B&R (SLC)	
	Optional accessories	
	Batteries	
0AC201.91	Lithium batteries 4 pcs., 3 V / 950 mAh button cell	
4A0006.00-000	Lithium battery, 3 V / 950 mAh, button cell	
	Interface modules	
4PP065.IF10-1	PP65 interface module, 1 RS232 interface	
4PP065.IF23-1	PP65 interface module, 1 RS232 interface, 1 RS485/RS422 interface, RS422 electrically isolated, RS485 electrically isolated and network-capable, RS232/RS485/RS422 in one connector, 1 CAN interface electrically isolated and network-capable, order 0TB704 terminal block separately	
4PP065.IF24-1	PP65 interface module, 1 PROFIBUS DP slave interface electrically isolated and network-capable, 1 RS232 interface, 1 RS422/RS485 interface, RS422/RS485: electrically isolated and network-capable, RS232/RS422/RS485 in one connector	
4PP065.IF33-1	PP65 interface module, 2 CAN interfaces electrically isolated and network-capable, order 0TB704 terminal block separately	
	Legend strips	
4A0069.00-000	5 piece of DIN A4 legend strips, 14 areas for all in all 35 PP65 3.5" devices, Download the CorelDraw file from the web site.	
	USB accessories	
5MMUSB.2048-01	USB 2.0 flash drive 2048 MB B&R	

Table 2: 4PP065.0351-P74 - Order data

4.2 Technical data

Model number	4PP065.0351-P74
General information	
B&R ID code	0xA966
LEDs	
Quantity	4
CF (CompactFlash)	Orange
Status	Red/Green
EPL (POWERLINK)	Red/Green
User	Green
Battery	
Type	Renata 950 mAh
Service life	4 years ¹⁾
Removable	Yes, accessible from the outside
Variant	Lithium ion
Power button	No
Reset button	No
Backup capacitor	
Buffer time	10 min
Certifications	
CE	Yes
UL	cULus E115267 Industrial control equipment
EAC	Yes
KC	Yes

Table 3: 4PP065.0351-P74 - Technical data

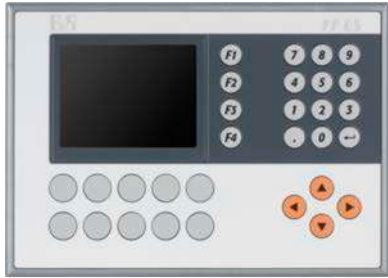
Model number	4PP065.0351-P74
Controller	
Bootloader, operating system	
PP65 supported starting with version	Automation Runtime, A3.01
Processor	
Type	Geode LX800, 32-bit x86
Clock frequency	500 MHz
L1 cache	128 kB (64 kB I-cache / 64 kB D-cache)
L2 cache	128 kB
Expanded command set	MMX technology, 3D Now
Floating point unit (FPU)	Yes
Flash	4 MB (for firmware)
Cooling	Passive via heat sink
Mode/Node switches	2, 16 positions each
Remanent variables	32 kB
Watchdog	MTCX ²⁾
Real-time clock	
Accuracy	At 25°C: Typ. 30 ppm (2.5 seconds) per day ³⁾
Battery-backed	Yes
Power failure logic	
Controller	MTCX ²⁾
Buffer time	10 ms
Graphics	
Controller	Geode LX800
Memory	8 MB shared memory (allocated in RAM)
Standard memory	
RAM	128 MB DDR SDRAM
User RAM	232 kB SRAM
PP65 Compact IF slot	1
Display	
Type	TFT color
Diagonal	3.5" (89 mm)
Colors	262,144
Resolution	QVGA, 320 x 240 pixels
Contrast	700:1
Viewing angles	
Horizontal	Direction R / Direction L = 80°
Vertical	Direction U / Direction D = 80°
Backlight	
Brightness	400 cd/m ²
Half-brightness time	50,000 h
Touch screen	
Technology	Analog, resistive
Controller	B&R, 12-bit
Transmittance	70% ±10%
Screen rotation	Yes (see chapter "Installation", section "Screen rotation")
Interfaces	
CompactFlash slot 1	
Quantity	1
Type	Type I
Variant	Primary IDE device
USB	
Quantity	2
Type	USB 2.0
Variant	Type A
Transfer rate	Low speed (1.5 Mbit/s), full speed (12 Mbit/s), high speed (480 Mbit/s)
Current-carrying capacity	Max. 500 mA per connection
Ethernet	
Quantity	1
Controller	Intel 82551ER
Variant	Shielded RJ45 port (10/100 Base-T)
Transfer rate	10/100 Mbit/s
Max. baud rate	100 Mbit/s
Cables	S/STP (Category 5)
LED status indicators	Link/Activity

Table 3: 4PP065.0351-P74 - Technical data

Model number	4PP065.0351-P74
POWERLINK	
Quantity	1
Fieldbus	POWERLINK (V1/V2)
Type	Type 4 ⁴⁾
Variant	Shielded RJ45 port
Transfer rate	100 Mbit/s
Transfer	100 Base-T (ANSI/IEEE 802.3)
Status LED	Link/Activity
Cable length	Max. 100 m between two stations (segment length)
Keys	
Variant	Membrane keypad with metallic snap-action disks
Total keys	30 membrane keys
Function keys	14 (with slide-in labels)
System keys	16 (number block, cursor block, control keys)
Service life	> 10 ⁶ actuations with 1 ±0.3 to 3 ±0.3 N operating force
Electrical properties	
Nominal voltage	24 VDC ±25%
Nominal current	0.45 A
Inrush current	Max. 2.8 A
Power consumption	Typ. 10 W
Galvanic isolation	No
Operating conditions	
Installation elevation above sea level	
0 to 2000 m	No limitation
>2000 m	Reduction of ambient temperature by 0.5°C per 100 m
Degree of protection per EN 60529	Back: IP20 (only with an inserted CompactFlash card) Front: IP65 / NEMA 250 type 4X, dust and sprayed water protection
Ambient conditions	
Temperature	
Operation	0 to 50°C
Storage	-20 to 70°C
Transport	-20 to 70°C
Relative humidity	
Operation	10 to 90%, non-condensing
Storage	T ≤ 40°C: 5 to 90%, non-condensing T > 40°C: <90%, non-condensing
Vibration	
Operation (continuous)	2 to 9 Hz: 1.75 mm amplitude / 9 to 200 Hz: 0.5 g
Operation (occasional)	2 to 9 Hz: 3.5 mm amplitude / 9 to 200 Hz: 1 g
Storage	2 to 8 Hz: 7.5 mm amplitude / 8 to 200 Hz: 2 g / 200 to 500 Hz: 4 g
Transport	2 to 8 Hz: 7.5 mm amplitude / 8 to 200 Hz: 2 g / 200 to 500 Hz: 4 g
Shock	
Operation	15 g, 11 ms
Storage	30 g, 15 ms
Transport	30 g, 15 ms
Mechanical properties	
Housing	
Material	Polyester
Front	Multi-layered panel overlay with insertion slots for key labels
Dimensions	
Width	203 mm
Height	145 mm
Depth	56.5 mm
Weight ⁵⁾	0.5 kg

Table 3: 4PP065.0351-P74 - Technical data

- 1) Typical service life (at 50% buffer operation: 25°C when device off, 50°C when device on).
Maximum service life in 24h operation (no buffer): 6 years at 25°C, 5 years at 50°C.
Maximum service life when device switched off: 2 years at 25°C, 1 year at 50°C.
- 2) Maintenance Controller Extended.
- 3) At max. specified ambient temperature: Typ. 50 ppm (4 s); worst case 100 ppm (8 s)
- 4) See the help system in Automation Studio under "Communication / POWERLINK / General information / Hardware - IF/LS".
- 5) Weight including fasteners and battery (46.5 g) but without an interface module.

4.3 Supported interface modules

Support for interface modules is provided starting with the following Automation Runtime versions:

	Interface modules			
	4PP065.IF10-1	4PP065.IF23-1	4PP065.IF24-1	4PP065.IF33-1
Automation Runtime version	A3.01	A3.01	A3.07	A3.01

POWERLINK V2

Red - Error	Description
On	<p>The POWERLINK interface is in an error state (failed Ethernet frames, increased number of collisions on the network, etc.).</p> <p>If an error occurs in the following statuses, then the green LED blinks over the red LED:</p> <ul style="list-style-type: none"> • BASIC_ETHERNET • PRE_OPERATIONAL_1 • PRE_OPERATIONAL_2 • READY_TO_OPERATE <p>Example:</p>
Green - Status	Description
Off NOT_ACTIVE	<p>Managing Node (MN) The bus is monitored for POWERLINK frames. If a frame is not received within the configured time window (timeout), the interface switches immediately to the PRE_OPERATIONAL_1 state (single flash). If, however, POWERLINK communication is detected before this time passes, the interface goes directly into the BASIC_ETHERNET state (flickering).</p> <p>Controlled node (CN) The bus is monitored for POWERLINK frames. If a frame is not received within the configured time window (timeout), the interface switches immediately to the BASIC_ETHERNET state (flickering). If POWERLINK communication is detected before this time expires, however, the interface switches immediately to the PRE_OPERATIONAL_1 state (single flash).</p>
Flickering green (approx. 10 Hz) BASIC_ETHERNET	<p>The interface is in the BASIC_ETHERNET state and being operated purely as an Ethernet TCP/IP interface.</p> <p>Managing node (MN) This state can only be exited by resetting the interface.</p> <p>Controlled node (CN) If POWERLINK communication is detected while in this state, the interface switches to the PRE_OPERATIONAL_1 state (single flash). In this status, a lit red LED indicates a manager error.</p>
Single flash (approx. 1 Hz) PRE_OPERATIONAL_1	<p>The interface status is in the PRE_OPERATIONAL_1 state.</p> <p>Managing node (MN) The MN starts "reduced cycle" operation. Collisions are allowed on the bus. Cyclic communication is not yet taking place.</p> <p>Controlled node (CN) The CN waits until it receives an SoC frame and then switches to the PRE_OPERATIONAL_2 state (double flash). In this status, a lit red LED indicates a manager error.</p>
Double flash (approx. 1 Hz) PRE_OPERATIONAL_2	<p>The interface is in the PRE_OPERATIONAL_2 state.</p> <p>Managing node (MN) The MN begins cyclic communication (cyclic input data is not yet being evaluated). The CNs are configured in this state.</p> <p>Controlled node (CN) The interface is normally configured by the manager in this state. A command then switches the state to READY_TO_OPERATE (triple flash). In this status, a lit red LED indicates a manager error.</p>
Triple flash (approx. 1 Hz) READY_TO_OPERATE	<p>The interface is in the READY_TO_OPERATE state.</p> <p>Managing node (MN) Cyclic and asynchronous communication is taking place. Received PDO data is ignored.</p> <p>Controlled node (CN) The configuration of the interface is complete. Normal cyclic and asynchronous communication is taking place. The PDO data sent corresponds to the PDO mapping. Cyclic data is not yet being evaluated, however. In this status, a lit red LED indicates a manager error.</p>
On OPERATIONAL	<p>The interface is in the OPERATIONAL state.</p>
Blinking (approx. 2.5 Hz) STOPPED	<p>The interface is in the STOPPED state.</p> <p>Managing node (MN) This status is not possible for the MN.</p> <p>Controlled node (CN) No output data is being produced, and no input data is being received. It is only possible to switch to or leave this state after the manager has given the appropriate command.</p>

System failure error codes

Incorrect configuration or defective hardware can cause a system failure error. The error code is indicated by the red EPL Error LED using four switch-on phases. Each switch-on phase has a duration of either 150 ms or 600 ms. The error code is repeated every 2 seconds.

Key

- ... 150 ms
- ... 600 ms
- Pause ... 2 second delay

Error description	Error code displayed by red EPL LED									
RAM error	•	•	•	-	Pause	•	•	•	-	Pause
Hardware error	-	•	•	-	Pause	-	•	•	-	Pause

4.4.4 ACT / LNK LEDs for the RJ45 interfaces

There are two additional LEDs each for the Ethernet and POWERLINK interfaces.

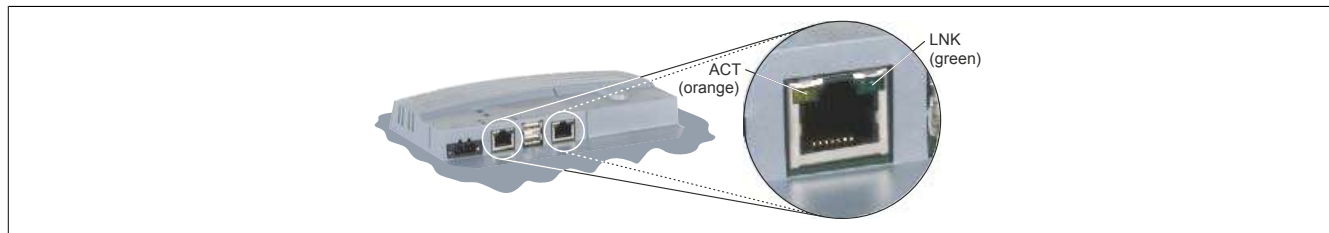

LED	Color	Status	Description
ACT	Orange	On	No Ethernet or POWERLINK activity on the bus
		Blinking	Ethernet or POWERLINK activity on the bus
LNK	Green	On	Link established to the remote station

4.5 Connection elements

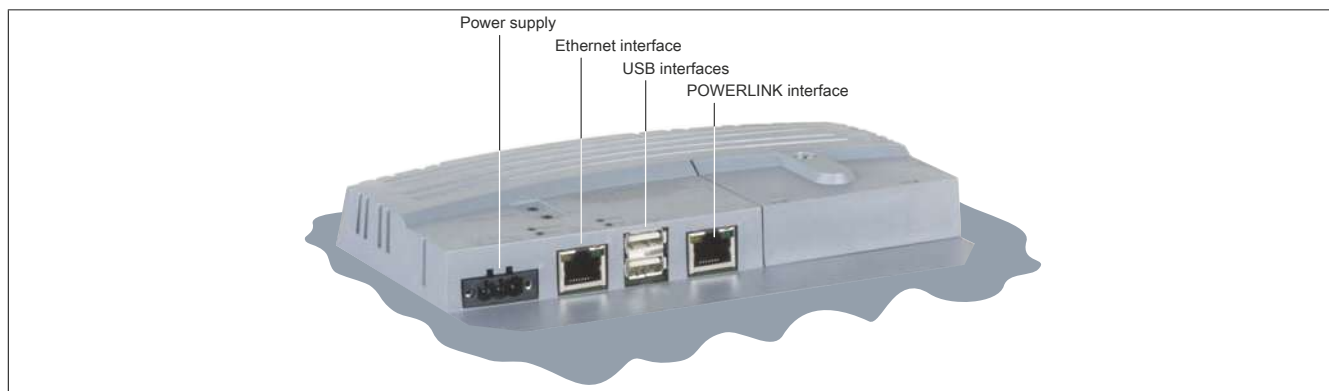

4.5.1 POWERLINK interface

Interface	Pinout		
	Terminal	POWERLINK	
POWERLINK interface Shielded RJ45 port	1	RXD	Receive signal
	2	RXD\	Receive signal inverted
	3	TXD	Transmit signal
	4	Termination	Termination
	5	Termination	Termination
	6	TXD\	Transmit signal inverted
	7	Termination	Termination
	8	Termination	Termination

4.5.2 USB interface

This Power Panel 65 features a USB 2.0 (Universal Serial Bus) host controller with two USB interfaces that are accessible externally for the user.

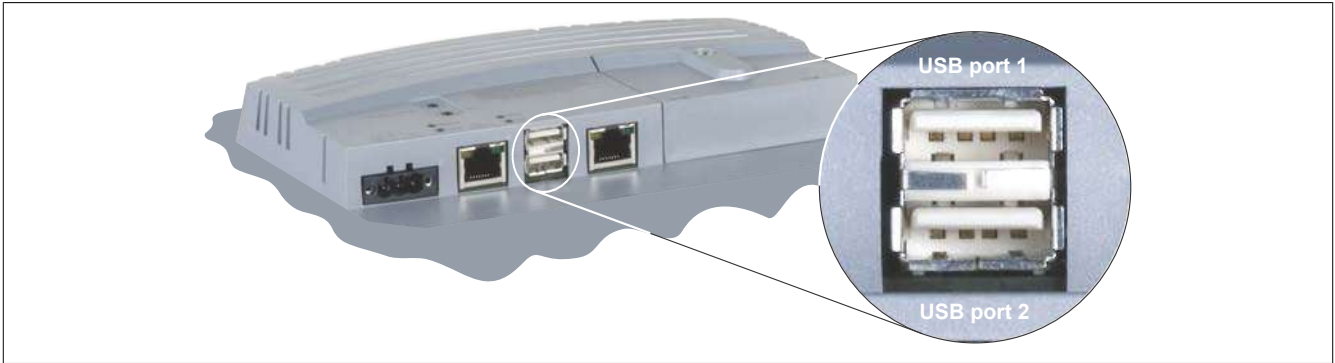

USB interface	
Transfer rate ¹⁾	Low speed (1.5 Mbit/s), full speed (12 Mbit/s), high speed (480 Mbit/s)
Power supply	Max. 0.5 A per port ²⁾

- 1) The actual value depends on the operating system or driver used.
- 2) Each USB interface is protected by a maintenance-free "USB current-limiting switch" (max. 0.5 A).

Warning!

Peripheral USB devices can be connected to the USB interfaces. Due to the large number of USB devices available on the market, B&R cannot guarantee their functionality. Functionality is ensured when using the USB devices available from B&R.

Notice!

Because this interface is designed according to general PC specifications, extreme care should be taken with regard to EMC, wiring, etc.

4.5.3 Ethernet interface

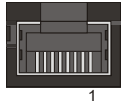
Interface	Pinout		
	Terminal	Ethernet	
Ethernet interface  RJ45 twisted pair female connector (10BaseT / 100BaseT)	1	RXD	Receive signal
	2	RXD\	Receive signal inverted
	3	TXD	Transmit signal
	4	Termination	Termination
	5	Termination	Termination
	6	TXD\	Transmit signal inverted
	7	Termination	Termination
	8	Termination	Termination

4.5.4 Power supply

The pinout is listed in the following table and printed on the back of the Power Panel. The Power Panel has reverse polarity protection that prevents the supply voltage from being connected incorrectly and damaging the device. Overload protection must be provided by an external fuse (5 A, fast-acting).

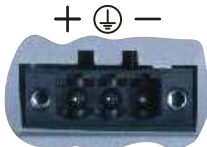
Power supply	Pinout	
	Terminal	Assignment
 3-pin male multipoint connector	+	24 VDC
	⊕	Functional ground
	-	GND
	Required accessories	
0TB103.9	Connector, 24 VDC, 3-pin female, 3.31 mm ² screw clamps, protected against vibration by the screw flange	
0TB103.91	Connector, 24 VDC, 3-pin female, 3.31 mm ² cage clamp terminal block, protected against vibration by the screw flange	

Notice!

The functional ground must be connected to ground (e.g. control cabinet) using the shortest possible path. Using the largest possible conductor cross section on the power supply connector is recommended.

4.6 Key assignments

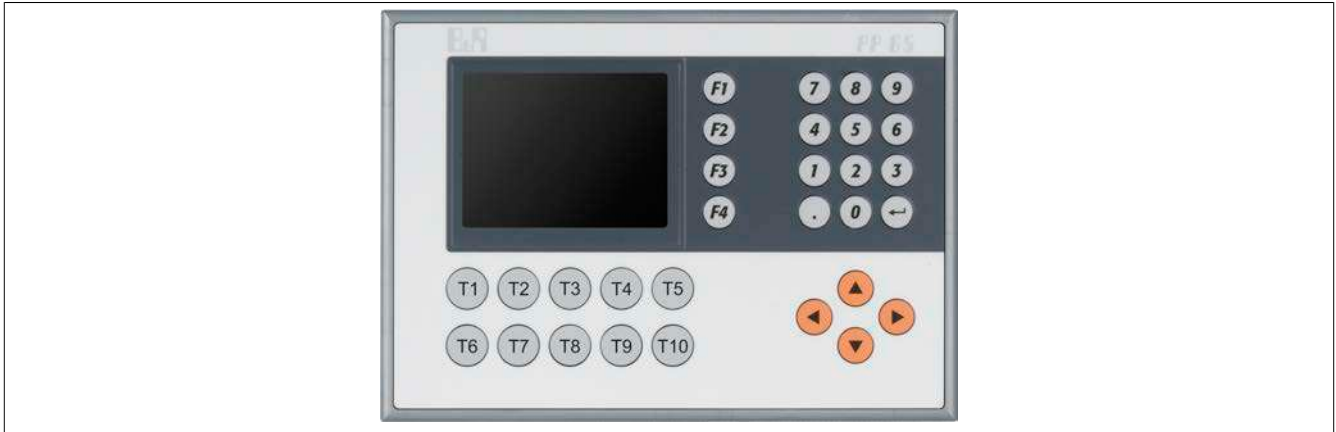

Key	Bit	Key	Bit	Key	Bit	Key	Bit	Key	Bit
F1	63	3	37	9	39	T3	8	T9	2
F2	62	4	54	0	44	T4	0	T10	58
F3	61	5	46	.	52	T5	56	◀	49
F4	60	6	38	↵	36	T6	26	▲	40
1	53	7	55	T1	24	T7	18	▶	33
2	45	8	47	T2	16	T8	10	▼	42

4.7 Operating mode and node number switches

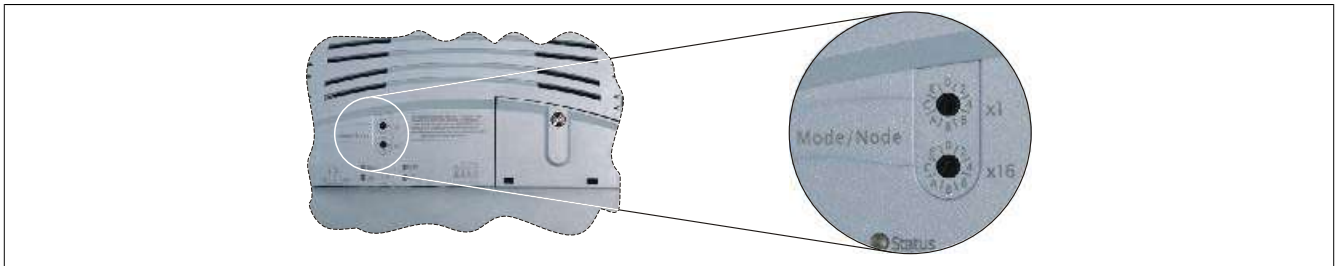

The Power Panel 65 is equipped with 2 hex switches that can be used as operating mode or node number switches. Switch positions 0x01 to 0xFE are used to set the INA node number of the Ethernet interface.

Switch position	Description
0x00	Reserved
0x01 to 0xFE	INA node number of the Ethernet interface
0xFF	Diagnostic mode: Starts up the CPU in diagnostic mode. Does not initialize program sections in User RAM and User FlashPROM. After diagnostic mode, the CPU always starts up with a warm restart.

4.8 Dimensions

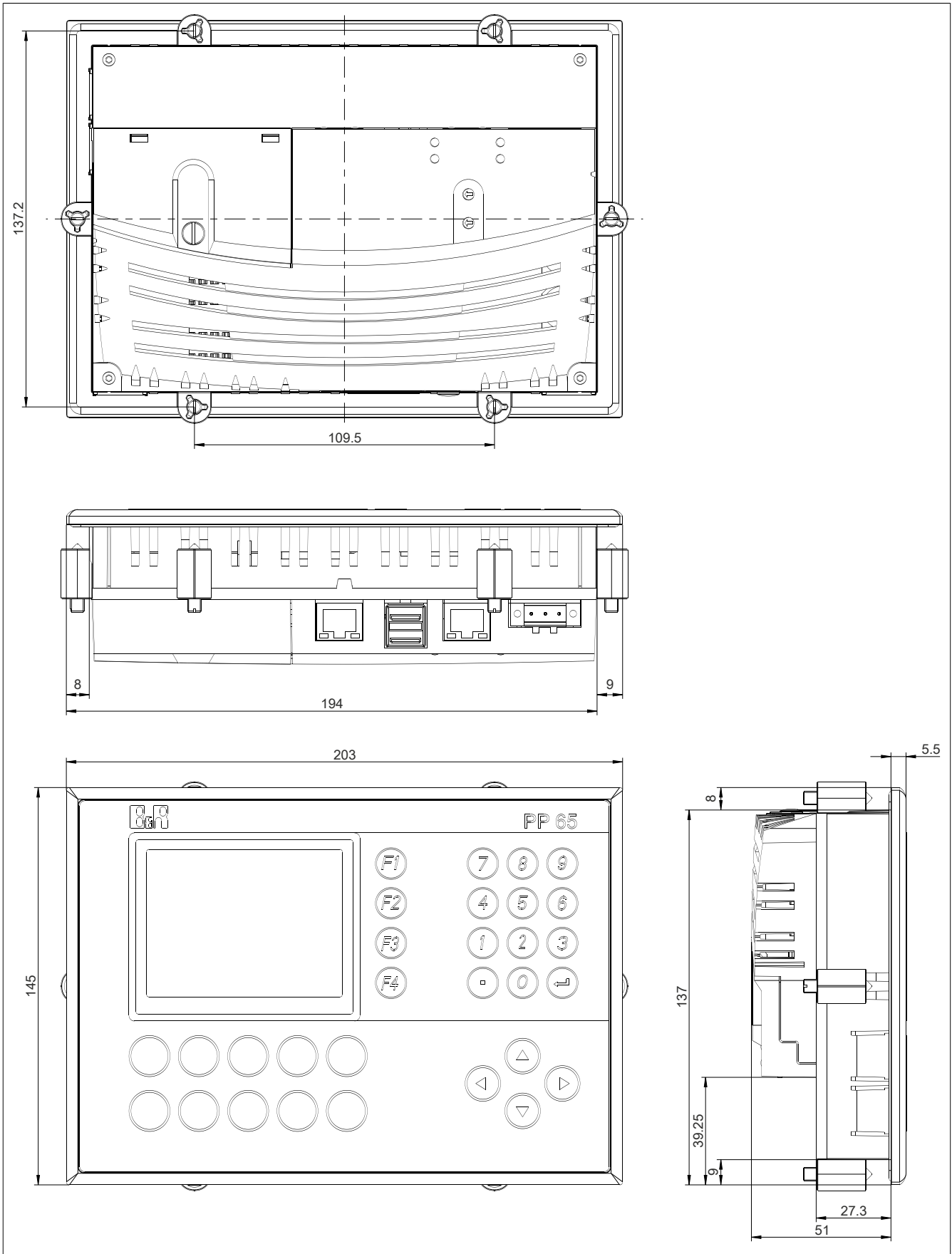

Installation cutout: 188 ±0.5 mm x 130 ±0.5 mm

5 4PP065.0351-X74

5.1 Order data

Model number	Short description	Figure
	Power Panel 65	
4PP065.0351-X74	Power Panel PP65, 3.5" QVGA color TFT display with touch screen (resistive), 30 function keys, 128 MB DRAM, 232 kB SRAM, CompactFlash slot, 1x ETH 10/100, 1x X2X Link, 2x USB, IP65 protection (front), order application memory separately Order OTB103 and OTB704 terminal blocks separately	
	Required accessories	
	Accessories	
OTB103.9	Connector 24 VDC - 3-pin female - Screw clamp terminal block 3.31 mm ²	
OTB103.91	Connector 24 VDC - 3-pin, female - Cage clamp terminal block 3.31 mm ²	
	CompactFlash cards	
0CFCRD.0512E.01	CompactFlash 512 MB extended temp.	
0CFCRD.2048E.01	CompactFlash 2048 MB extended temp.	
5CFCRD.0512-06	CompactFlash 512 MB B&R (SLC)	
5CFCRD.1024-06	CompactFlash 1 GB B&R (SLC)	
5CFCRD.2048-06	CompactFlash 2 GB B&R (SLC)	
5CFCRD.4096-06	CompactFlash 4 GB B&R (SLC)	
	Terminal blocks	
OTB704.9	Accessory terminal block, 4-pin, screw clamp terminal block 2.5 mm ²	
OTB704.91	Accessory terminal block, 4-pin, push-in terminal block 2.5 mm ²	
	Optional accessories	
	Batteries	
0AC201.91	Lithium batteries 4 pcs., 3 V / 950 mAh button cell	
4A0006.00-000	Lithium battery, 3 V / 950 mAh, button cell	
	Interface modules	
4PP065.IF10-1	PP65 interface module, 1 RS232 interface	
4PP065.IF23-1	PP65 interface module, 1 RS232 interface, 1 RS485/RS422 interface, RS422 electrically isolated, RS485 electrically isolated and network-capable, RS232/RS485/RS422 in one connector, 1 CAN interface electrically isolated and network-capable, order OTB704 terminal block separately	
4PP065.IF24-1	PP65 interface module, 1 PROFIBUS DP slave interface electrically isolated and network-capable, 1 RS232 interface, 1 RS422/RS485 interface, RS422/RS485: electrically isolated and network-capable, RS232/RS422/RS485 in one connector	
4PP065.IF33-1	PP65 interface module, 2 CAN interfaces electrically isolated and network-capable, order OTB704 terminal block separately	
	Legend strips	
4A0069.00-000	5 piece of DIN A4 legend strips, 14 areas for all in all 35 PP65 3.5" devices, Download the CorelDraw file from the web site.	
	USB accessories	
5MMUSB.2048-01	USB 2.0 flash drive 2048 MB B&R	

Table 4: 4PP065.0351-X74 - Order data

5.2 Technical data

Model number	4PP065.0351-X74
General information	
B&R ID code	0xA965
LEDs	
Quantity	4
CF (CompactFlash)	Orange
Status	Red/Green
X2X	Orange
User	Green
Battery	
Type	Renata 950 mAh
Service life	4 years ¹⁾
Removable	Yes, accessible from the outside
Variant	Lithium ion
Power button	No
Reset button	No
Backup capacitor	
Buffer time	10 min

Table 5: 4PP065.0351-X74 - Technical data

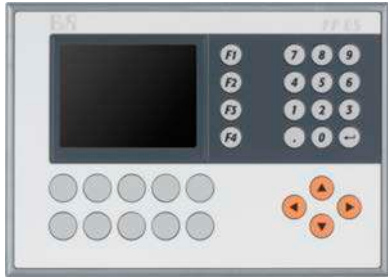
Model number	4PP065.0351-X74
Certifications	
CE	Yes
UL	cULus E115267 Industrial control equipment
EAC	Yes
Controller	
Bootloader, operating system	
PP65 supported starting with version	Automation Runtime, C2.96
Processor	
Type	Geode LX800, 32-bit x86
Clock frequency	500 MHz
L1 cache	128 kB (64 kB I-cache / 64 kB D-cache)
L2 cache	128 kB
Expanded command set	MMX technology, 3D Now
Floating point unit (FPU)	Yes
Flash	4 MB (for firmware)
Cooling	Passive via heat sink
Mode/Node switches	2, 16 positions each
Remanent variables	32 kB
Watchdog	MTCX ²⁾
Real-time clock	
Accuracy	At 25°C: Typ. 30 ppm (2.5 seconds) per day ³⁾
Battery-backed	Yes
Power failure logic	
Controller	MTCX ²⁾
Buffer time	10 ms
Graphics	
Controller	Geode LX800
Memory	8 MB shared memory (allocated in RAM)
Standard memory	
RAM	128 MB DDR SDRAM
User RAM	232 kB SRAM
PP65 Compact IF slot	1
Display	
Type	TFT color
Diagonal	3.5" (89 mm)
Colors	262,144
Resolution	QVGA, 320 x 240 pixels
Contrast	700:1
Viewing angles	
Horizontal	Direction R / Direction L = 80°
Vertical	Direction U / Direction D = 80°
Backlight	
Brightness	400 cd/m ²
Half-brightness time	50,000 h
Touch screen	
Technology	Analog, resistive
Controller	B&R, 12-bit
Transmittance	70% ±10%
Screen rotation	Yes (see chapter "Installation", section "Screen rotation")
Interfaces	
CompactFlash slot 1	
Quantity	1
Type	Type I
Variant	Primary IDE device
USB	
Quantity	2
Type	USB 2.0
Variant	Type A
Transfer rate	Low speed (1.5 Mbit/s), full speed (12 Mbit/s), high speed (480 Mbit/s)
Current-carrying capacity	Max. 500 mA per connection
Ethernet	
Quantity	1
Controller	Intel 82551ER
Variant	Shielded RJ45 port (10/100 Base-T)
Transfer rate	10/100 Mbit/s
Max. baud rate	100 Mbit/s
Cables	S/STP (Category 5)
LED status indicators	Link/Activity

Table 5: 4PP065.0351-X74 - Technical data

Model number	4PP065.0351-X74
X2X	
Type	X2X Link master
Quantity	1
Variant	4-pin male multipoint connector
Internal bus power supply	No
Number of stations	Max. 253
Distance between 2 stations	Max. 100 m
Network topology	Line
Terminating resistor	Internal
Keys	
Variant	Membrane keypad with metallic snap-action disks
Total keys	30 membrane keys
Function keys	14 (with slide-in labels)
System keys	16 (number block, cursor block, control keys)
Service life	> 10 ⁶ actuations with 1 ±0.3 to 3 ±0.3 N operating force
Electrical properties	
Nominal voltage	24 VDC ±25%
Nominal current	0.45 A
Inrush current	Max. 2.8 A
Power consumption	Typ. 10 W
Galvanic isolation	No
Operating conditions	
Installation elevation above sea level	
0 to 2000 m	No limitation
>2000 m	Reduction of ambient temperature by 0.5°C per 100 m
Degree of protection per EN 60529	Back: IP20 (only with an inserted CompactFlash card) Front: IP65 / NEMA 250 type 4X, dust and sprayed water protection
Ambient conditions	
Temperature	
Operation	0 to 50°C
Storage	-20 to 70°C
Transport	-20 to 70°C
Relative humidity	
Operation	10 to 90%, non-condensing
Storage	T ≤ 40°C: 5 to 90%, non-condensing T > 40°C: <90%, non-condensing
Vibration	
Operation (continuous)	2 to 9 Hz: 1.75 mm amplitude / 9 to 200 Hz: 0.5 g
Operation (occasional)	2 to 9 Hz: 3.5 mm amplitude / 9 to 200 Hz: 1 g
Storage	2 to 8 Hz: 7.5 mm amplitude / 8 to 200 Hz: 2 g / 200 to 500 Hz: 4 g
Transport	2 to 8 Hz: 7.5 mm amplitude / 8 to 200 Hz: 2 g / 200 to 500 Hz: 4 g
Shock	
Operation	15 g, 11 ms
Storage	30 g, 15 ms
Transport	30 g, 15 ms
Mechanical properties	
Housing	
Material	Polyester
Front	Multi-layered panel overlay with insertion slots for key labels
Dimensions	
Width	203 mm
Height	145 mm
Depth	56.5 mm
Weight ⁴⁾	0.5 kg

Table 5: 4PP065.0351-X74 - Technical data

- 1) Typical service life (at 50% buffer operation: 25°C when device off, 50°C when device on).
Maximum service life in 24h operation (no buffer): 6 years at 25°C, 5 years at 50°C.
Maximum service life when device switched off: 2 years at 25°C, 1 year at 50°C.
- 2) Maintenance Controller Extended.
- 3) At max. specified ambient temperature: Typ. 50 ppm (4 s); worst case 100 ppm (8 s)
- 4) Weight including fasteners and battery (46.5 g) but without an interface module.

5.3 Supported interface modules

Support for interface modules is provided starting with the following Automation Runtime versions:

Automation Runtime version	Interface modules			
	4PP065.IF10-1	4PP065.IF23-1	4PP065.IF24-1	4PP065.IF33-1
	C2.96	C2.96	A3.07	C2.96

5.5 Connection elements

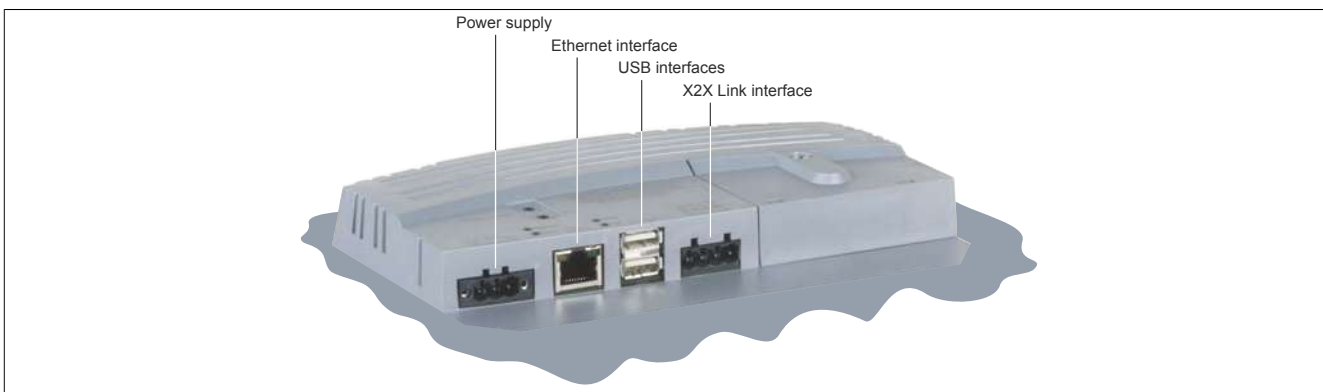

5.5.1 X2X Link interface

Interface	Pinout		
User interface X2X Link	Terminal	X2X Link	
	1	X2X	X2X data
	2	X2XL	X2X ground
	3	X2XI	X2X data inverted
	4	SHLD	Shield
	Required accessories		
	0TB704.9	Accessory terminal block, 4-pin, screw clamp terminal block 2.5 mm ²	
	0TB704.91	Accessory terminal block, 4-pin, cage clamp terminal block, 2.5 mm ²	

4-pin male multipoint connector

5.5.2 USB interface

This Power Panel 65 features a USB 2.0 (Universal Serial Bus) host controller with two USB interfaces that are accessible externally for the user.

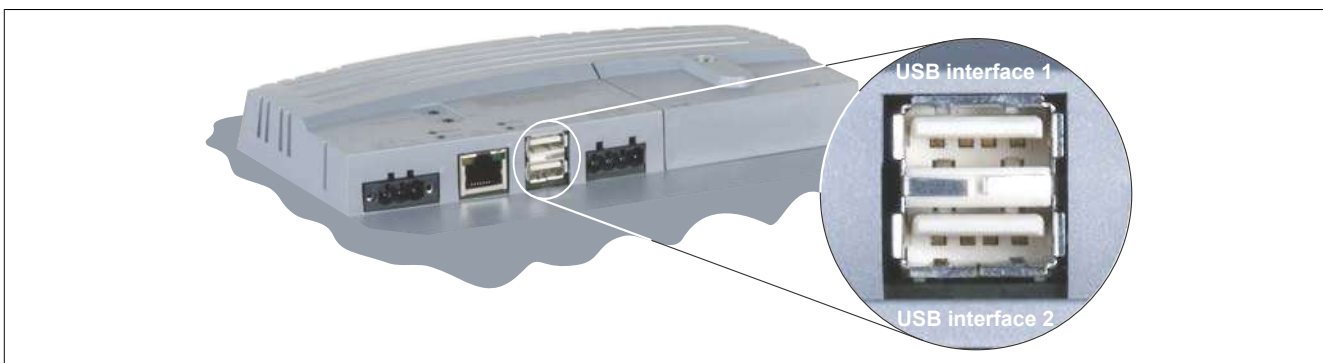

USB interface	
Transfer rate ¹⁾	Low speed (1.5 Mbit/s), full speed (12 Mbit/s), high speed (480 Mbit/s)
Power supply	Max. 0.5 A per port ²⁾

- 1) The actual value depends on the operating system or driver used.
- 2) Each USB interface is protected by a maintenance-free "USB current-limiting switch" (max. 0.5 A).

Warning!

Peripheral USB devices can be connected to the USB interfaces. Due to the large number of USB devices available on the market, B&R cannot guarantee their functionality. Functionality is ensured when using the USB devices available from B&R.

Notice!

Because this interface is designed according to general PC specifications, extreme care should be taken with regard to EMC, wiring, etc.

5.5.3 Ethernet interface

Interface	Pinout		
	Terminal	Ethernet	
Ethernet interface  1 RJ45 twisted pair female connector (10BaseT / 100BaseT)	1	RXD	Receive signal
	2	RXD\	Receive signal inverted
	3	TXD	Transmit signal
	4	Termination	Termination
	5	Termination	Termination
	6	TXD\	Transmit signal inverted
	7	Termination	Termination
	8	Termination	Termination

5.5.4 Power supply

The pinout is listed in the following table and printed on the back of the Power Panel. The Power Panel has reverse polarity protection that prevents the supply voltage from being connected incorrectly and damaging the device. Overload protection must be provided by an external fuse (5 A, fast-acting).

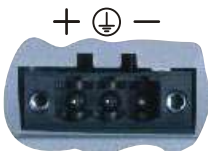
Power supply	Pinout	
	Terminal	Assignment
 3-pin male multipoint connector	+	24 VDC
	⊥	Functional ground
	—	GND
	Required accessories	
0TB103.9	Connector, 24 VDC, 3-pin female, 3.31 mm ² screw clamps, protected against vibration by the screw flange	
0TB103.91	Connector, 24 VDC, 3-pin female, 3.31 mm ² cage clamp terminal block, protected against vibration by the screw flange	

Notice!

The functional ground must be connected to ground (e.g. control cabinet) using the shortest possible path. Using the largest possible conductor cross section on the power supply connector is recommended.

5.6 Key assignments



Key	Bit	Key	Bit	Key	Bit	Key	Bit	Key	Bit
F1	63	3	37	9	39	T3	8	T9	2
F2	62	4	54	0	44	T4	0	T10	58
F3	61	5	46	.	52	T5	56	◀	49
F4	60	6	38	↵	36	T6	26	▲	40
1	53	7	55	T1	24	T7	18	▶	33
2	45	8	47	T2	16	T8	10	▼	42

5.7 Operating mode and node number switches

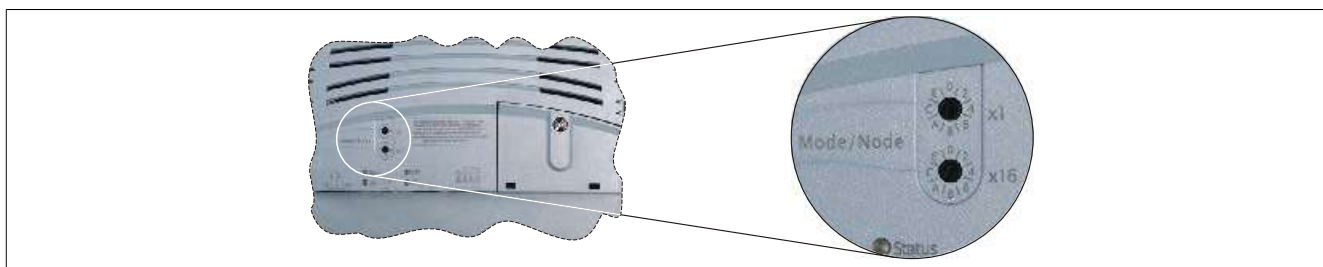

The Power Panel 65 is equipped with 2 hex switches that can be used as operating mode or node number switches. Switch positions 0x01 to 0xFE are used to set the INA node number of the Ethernet interface.

Switch position	Description
0x00	Reserved
0x01 to 0xFE	INA node number of the Ethernet interface
0xFF	Diagnostic mode: Starts up the CPU in diagnostic mode. Does not initialize program sections in User RAM and User FlashPROM. After diagnostic mode, the CPU always starts up with a warm restart.

5.8 Dimensions

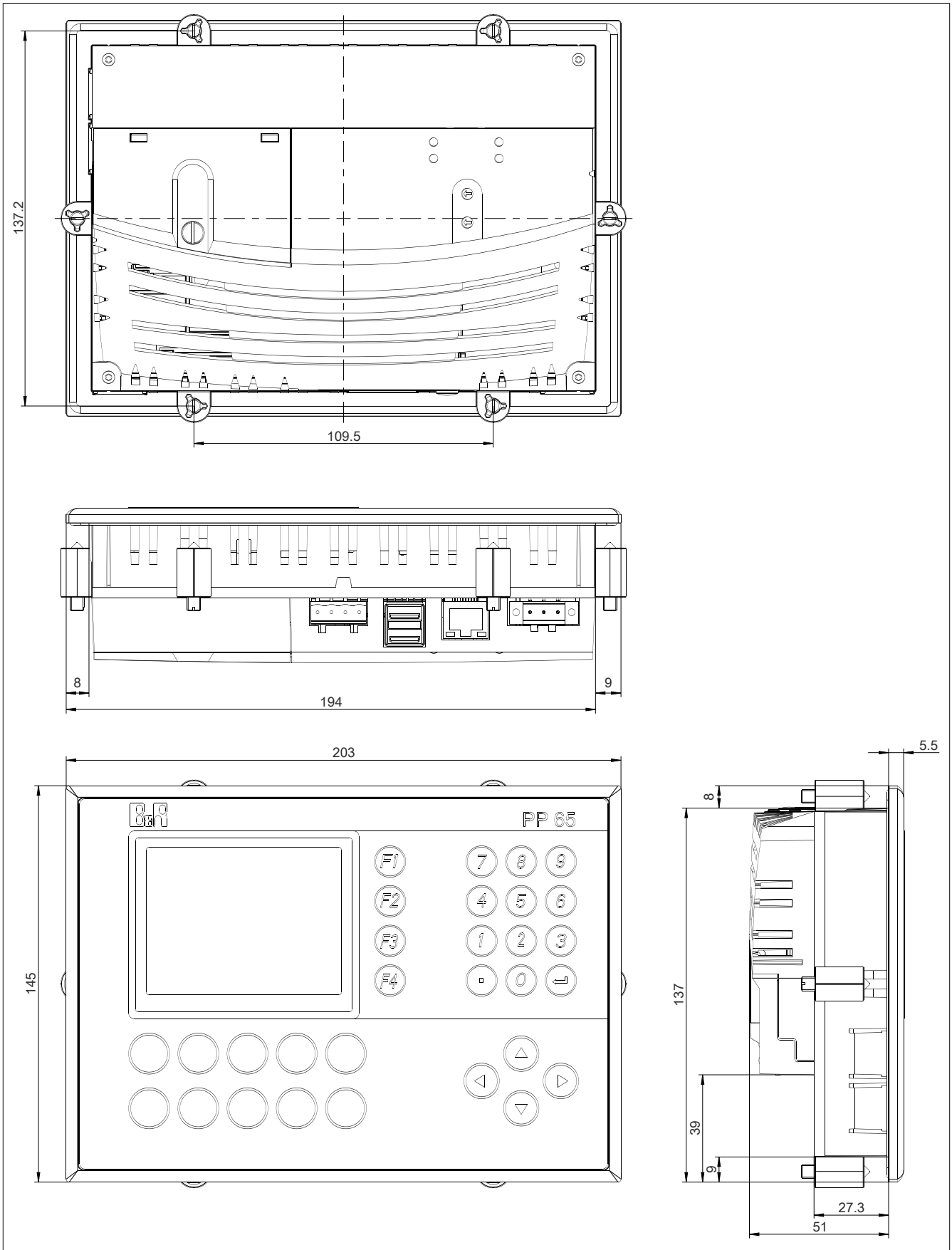

Installation cutout: 188 ±0.5 mm x 130 ±0.5 mm

6 4PP065.0571-P74

6.1 Order data

Model number	Short description	Figure
	Power Panel 65	
4PP065.0571-P74	Power Panel PP65, 5.7" QVGA color TFT display with touch screen (resistive), 128 MB DRAM, 232 kB SRAM, CompactFlash slot, 1x ETH 10/100, 1x POWERLINK, 2x USB, IP65 protection (front), order application memory separately Order 0TB103 terminal block separately	
	Required accessories	
	Accessories	
0TB103.9	Connector 24 VDC - 3-pin female - Screw clamp terminal block 3.31 mm ²	
0TB103.91	Connector 24 VDC - 3-pin, female - Cage clamp terminal block 3.31 mm ²	
	CompactFlash cards	
0CFCRD.0512E.01	CompactFlash 512 MB extended temp.	
0CFCRD.2048E.01	CompactFlash 2048 MB extended temp.	
5CFCRD.0512-06	CompactFlash 512 MB B&R (SLC)	
5CFCRD.1024-06	CompactFlash 1 GB B&R (SLC)	
5CFCRD.2048-06	CompactFlash 2 GB B&R (SLC)	
5CFCRD.4096-06	CompactFlash 4 GB B&R (SLC)	
	Optional accessories	
	Batteries	
0AC201.91	Lithium batteries 4 pcs., 3 V / 950 mAh button cell	
4A0006.00-000	Lithium battery, 3 V / 950 mAh, button cell	
	Interface modules	
4PP065.IF10-1	PP65 interface module, 1 RS232 interface	
4PP065.IF23-1	PP65 interface module, 1 RS232 interface, 1 RS485/RS422 interface, RS422 electrically isolated, RS485 electrically isolated and network-capable, RS232/RS485/RS422 in one connector, 1 CAN interface electrically isolated and network-capable, order 0TB704 terminal block separately	
4PP065.IF24-1	PP65 interface module, 1 PROFIBUS DP slave interface electrically isolated and network-capable, 1 RS232 interface, 1 RS422/RS485 interface, RS422/RS485: electrically isolated and network-capable, RS232/RS422/RS485 in one connector	
4PP065.IF33-1	PP65 interface module, 2 CAN interfaces electrically isolated and network-capable, order 0TB704 terminal block separately	
	USB accessories	
5MMUSB.2048-01	USB 2.0 flash drive 2048 MB B&R	

Table 6: 4PP065.0571-P74 - Order data

6.2 Technical data

Model number	4PP065.0571-P74
General information	
B&R ID code	0xA964
LEDs	
Quantity	4
CF (CompactFlash)	Orange
Status	Red/Green
EPL (POWERLINK)	Red/Green
User	Green
Battery	
Type	Renata 950 mAh
Service life	4 years ¹⁾
Removable	Yes, accessible from the outside
Variant	Lithium ion
Backup capacitor	
Buffer time	10 min
Certifications	
CE	Yes
UL	cULus E115267 Industrial control equipment
EAC	Yes
Controller	
Bootloader, operating system	
PP65 supported starting with version	Automation Runtime, A3.01

Table 7: 4PP065.0571-P74 - Technical data

Model number	4PP065.0571-P74
Processor	
Type	Geode LX800, 32-bit x86
Clock frequency	500 MHz
L1 cache	128 kB (64 kB I-cache / 64 kB D-cache)
L2 cache	128 kB
Expanded command set	MMX technology, 3D Now
Floating point unit (FPU)	Yes
Flash	4 MB (for firmware)
Cooling	Passive via heat sink
Mode/Node switches	2, 16 positions each
Remanent variables	32 kB
Watchdog	MTCX ²⁾
Real-time clock	
Accuracy	At 25°C: Typ. 30 ppm (2.5 seconds) per day ³⁾
Battery-backed	Yes
Power failure logic	
Controller	MTCX ²⁾
Buffer time	10 ms
Graphics	
Controller	Geode LX800
Memory	8 MB shared memory (allocated in RAM)
Standard memory	
RAM	128 MB DDR SDRAM
User RAM	232 kB SRAM
PP65 Compact IF slot	1
Display	
Type	TFT color
Diagonal	5.7" (144 mm)
Colors	262,144
Resolution	QVGA, 320 x 240 pixels
Contrast	350:1
Viewing angles	
Horizontal	Direction R / Direction L = 60°
Vertical	Direction U = 65° / Direction D = 50°
Backlight	
Brightness	500 cd/m ²
Half-brightness time	50,000 h
Touch screen	
Technology	Analog, resistive
Controller	B&R, 12-bit
Transmittance	70% ±10%
Screen rotation	Yes (see chapter "Installation", section "Screen rotation")
Interfaces	
CompactFlash slot 1	
Quantity	1
Type	Type I
Variant	Primary IDE device
USB	
Quantity	2
Type	USB 2.0
Variant	Type A
Transfer rate	Low speed (1.5 Mbit/s), full speed (12 Mbit/s), high speed (480 Mbit/s)
Current-carrying capacity	Max. 500 mA per connection
Ethernet	
Quantity	1
Controller	Intel 82551ER
Variant	Shielded RJ45 port (10/100 Base-T)
Transfer rate	10/100 Mbit/s
Max. baud rate	100 Mbit/s
Cables	S/STP (Category 5)
LED status indicators	Link/Activity
POWERLINK	
Quantity	1
Fieldbus	POWERLINK (V1/V2)
Type	Type 4 ⁴⁾
Variant	Shielded RJ45 port
Transfer rate	100 Mbit/s
Transfer	100 Base-T (ANSI/IEEE 802.3)
Status LED	Link/Activity
Cable length	Max. 100 m between two stations (segment length)
Electrical properties	
Nominal voltage	24 VDC ±25%

Table 7: 4PP065.0571-P74 - Technical data

Model number	4PP065.0571-P74
Nominal current	0.45 A
Inrush current	Max. 2.8 A
Power consumption	Typ. 10 W
Galvanic isolation	No
Operating conditions	
Installation elevation above sea level	
0 to 2000 m	No limitation
>2000 m	Reduction of ambient temperature by 0.5°C per 100 m
Degree of protection per EN 60529	Back: IP20 (only with an inserted CompactFlash card) Front: IP65 / NEMA 250 type 4X, dust and sprayed water protection
Ambient conditions	
Temperature	
Operation	0 to 50°C
Storage	-20 to 70°C
Transport	-20 to 70°C
Relative humidity	
Operation	10 to 90%, non-condensing
Storage	T ≤ 40°C: 5 to 90%, non-condensing T > 40°C: <90%, non-condensing
Vibration	
Operation (continuous)	2 to 9 Hz: 1.75 mm amplitude / 9 to 200 Hz: 0.5 g
Operation (occasional)	2 to 9 Hz: 3.5 mm amplitude / 9 to 200 Hz: 1 g
Storage	2 to 8 Hz: 7.5 mm amplitude / 8 to 200 Hz: 2 g / 200 to 500 Hz: 4 g
Transport	2 to 8 Hz: 7.5 mm amplitude / 8 to 200 Hz: 2 g / 200 to 500 Hz: 4 g
Shock	
Operation	15 g, 11 ms
Storage	30 g, 15 ms
Transport	30 g, 15 ms
Mechanical properties	
Housing	
Material	Polyester
Front	Multi-layered panel overlay
Dimensions	
Width	203 mm
Height	145 mm
Depth	56.5 mm
Weight ⁵⁾	0.75 kg

Table 7: 4PP065.0571-P74 - Technical data

- 1) Typical service life (at 50% buffer operation: 25°C when device off, 50°C when device on).
Maximum service life in 24h operation (no buffer): 6 years at 25°C, 5 years at 50°C.
Maximum service life when device switched off: 2 years at 25°C, 1 year at 50°C.
- 2) Maintenance Controller Extended.
- 3) At max. specified ambient temperature: Typ. 50 ppm (4 s); worst case 100 ppm (8 s)
- 4) See the help system in Automation Studio under "Communication / POWERLINK / General information / Hardware - IF/LS".
- 5) Weight including fasteners and battery (46.5 g) but without an interface module.

6.3 Supported interface modules

Support for interface modules is provided starting with the following Automation Runtime versions:

	Interface modules			
	4PP065.IF10-1	4PP065.IF23-1	4PP065.IF24-1	4PP065.IF33-1
Automation Runtime version	A3.01	A3.01	A3.07	A3.01

6.4 Diagnostic LEDs

There are four diagnostic LEDs on the back of the PP65.

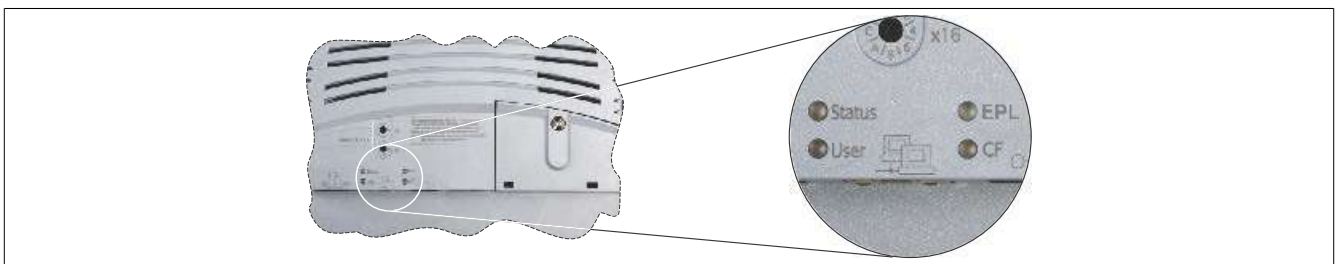

Information:

The behavior of the Status LED has changed starting with AR J2.96, E3.01 and B3.06.

6.4.1 Diagnostic LEDs up to AR I2.96, D3.01 and A3.06

LED	Color	Status	Description
Status	Red	On	Error/Reset
	Orange	On	Boot or Ready mode
User	Green	On/Off	LED operable by the user (with the AsHW library)
EPL	See "EPL LED" on page 39.		
CF	Orange	On	CompactFlash card being accessed

6.4.2 Diagnostic LEDs starting with AR J2.96, E3.01 and B3.06

LED	Color	Status	Description
Status	see following table "Status LED blink codes"		
User	Green	On/Off	LED operable by the user (with the AsHW library)
EPL	See "EPL LED" on page 39.		
CF	Orange	On	CompactFlash card being accessed

Blink codes (200 ms pattern)	Function
	Error/Reset
	No errors, normal operation
	Battery not installed or battery capacity too low
	CompactFlash media not found
	Reserved for future blink codes

Because blink codes can only signal one error at a time, errors with higher priority take precedence. Fatal errors have a higher priority than less significant errors (e.g. low battery capacity).

6.4.3 EPL LED

The EPL LED is a green (Status) / red (Error) dual LED. The status of the LEDs has different meanings depending on the operating mode (Ethernet TCP/IP mode, POWERLINK V1 or POWERLINK V2).

Ethernet TCP/IP mode

The POWERLINK interface can be operated purely as an Ethernet TCP/IP interface.

Green - Status	Description
On	POWERLINK interface operating purely as an Ethernet TCP/IP interface

POWERLINK V1

EPL LED		Status of the POWERLINK station
Green	Red	
On	Off	The POWERLINK station is running with no errors.
Off	On	A fatal system error has occurred. The error type can be read using the PLC logbook. An irreparable problem has occurred. The system cannot properly carry out its tasks. This state can only be changed by resetting the module.
Blinking alternately		The POWERLINK managing node has failed. This error code can only occur when operated as a controlled node. This means that the configured station number lies within the range 0x01 - 0xFD.
Off	Blink code	System error: The red blinking LED signals an error code (see "System stop error codes" on page 40).

POWERLINK V2

Red - Error	Description
On	<p>The POWERLINK interface is in an error state (failed Ethernet frames, increased number of collisions on the network, etc.).</p> <p>If an error occurs in the following statuses, then the green LED blinks over the red LED:</p> <ul style="list-style-type: none"> • BASIC_ETHERNET • PRE_OPERATIONAL_1 • PRE_OPERATIONAL_2 • READY_TO_OPERATE <p>Example:</p>

Green - Status	Description
Off NOT_ACTIVE	<p>Managing Node (MN) The bus is monitored for POWERLINK frames. If a frame is not received within the configured time window (timeout), the interface switches immediately to the PRE_OPERATIONAL_1 state (single flash). If, however, POWERLINK communication is detected before this time passes, the interface goes directly into the BASIC_ETHERNET state (flickering).</p> <p>Controlled node (CN) The bus is monitored for POWERLINK frames. If a frame is not received within the configured time window (timeout), the interface switches immediately to the BASIC_ETHERNET state (flickering). If POWERLINK communication is detected before this time expires, however, the interface switches immediately to the PRE_OPERATIONAL_1 state (single flash).</p>
Flickering green (approx. 10 Hz) BASIC_ETHERNET	<p>The interface is in the BASIC_ETHERNET state and being operated purely as an Ethernet TCP/IP interface.</p> <p>Managing node (MN) This state can only be exited by resetting the interface.</p> <p>Controlled node (CN) If POWERLINK communication is detected while in this state, the interface switches to the PRE_OPERATIONAL_1 state (single flash). In this status, a lit red LED indicates a manager error.</p>
Single flash (approx. 1 Hz) PRE_OPERATIONAL_1	<p>The interface status is in the PRE_OPERATIONAL_1 state.</p> <p>Managing node (MN) The MN starts "reduced cycle" operation. Collisions are allowed on the bus. Cyclic communication is not yet taking place.</p> <p>Controlled node (CN) The CN waits until it receives an SoC frame and then switches to the PRE_OPERATIONAL_2 state (double flash). In this status, a lit red LED indicates a manager error.</p>
Double flash (approx. 1 Hz) PRE_OPERATIONAL_2	<p>The interface is in the PRE_OPERATIONAL_2 state.</p> <p>Managing node (MN) The MN begins cyclic communication (cyclic input data is not yet being evaluated). The CNs are configured in this state.</p> <p>Controlled node (CN) The interface is normally configured by the manager in this state. A command then switches the state to READY_TO_OPERATE (triple flash). In this status, a lit red LED indicates a manager error.</p>
Triple flash (approx. 1 Hz) READY_TO_OPERATE	<p>The interface is in the READY_TO_OPERATE state.</p> <p>Managing node (MN) Cyclic and asynchronous communication is taking place. Received PDO data is ignored.</p> <p>Controlled node (CN) The configuration of the interface is complete. Normal cyclic and asynchronous communication is taking place. The PDO data sent corresponds to the PDO mapping. Cyclic data is not yet being evaluated, however. In this status, a lit red LED indicates a manager error.</p>
On OPERATIONAL	<p>The interface is in the OPERATIONAL state.</p>
Blinking (approx. 2.5 Hz) STOPPED	<p>The interface is in the STOPPED state.</p> <p>Managing node (MN) This status is not possible for the MN.</p> <p>Controlled node (CN) No output data is being produced, and no input data is being received. It is only possible to switch to or leave this state after the manager has given the appropriate command.</p>

System stop error codes

Incorrect configuration or defective hardware can cause a system failure error.

The error code is indicated by the red EPL Error LED using four switch-on phases. Each switch-on phase has a duration of either 150 ms or 600 ms. The error code is repeated every 2 seconds.

Key	•	... 150 ms
	-	... 600 ms
	Pause	... 2 second delay

Error description	Error code displayed by red EPL LED									
RAM error	•	•	•	-	Pause	•	•	•	-	Pause
Hardware error	-	•	•	-	Pause	-	•	•	-	Pause

6.4.4 ACT / LNK LEDs for the RJ45 interfaces

There are two additional LEDs each for the Ethernet and POWERLINK interfaces.

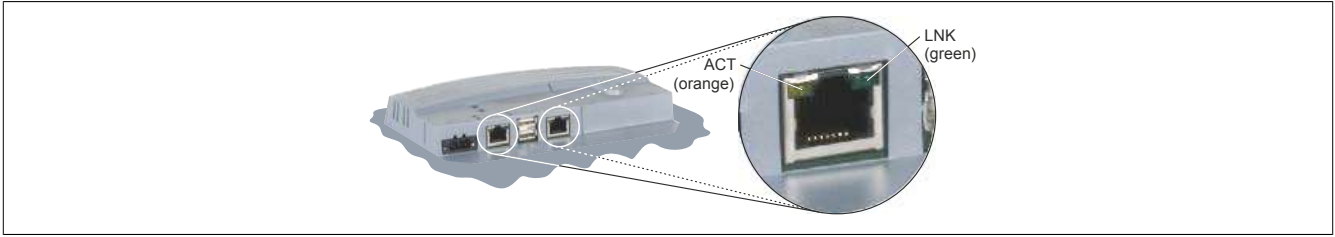

LED	Color	Status	Description
ACT	Orange	On	No Ethernet or POWERLINK activity on the bus
		Blinking	Ethernet or POWERLINK activity on the bus
LNK	Green	On	Link established to the remote station

6.5 Connection elements

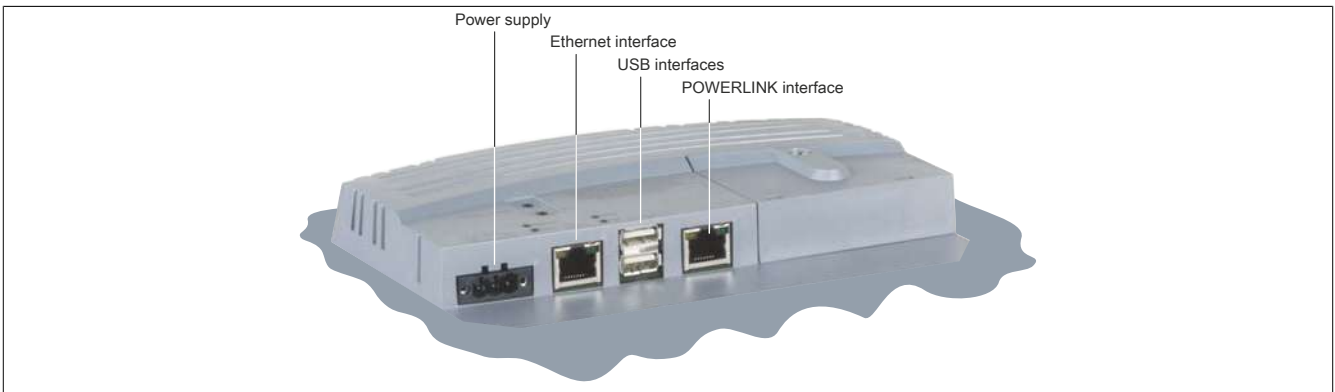

6.5.1 POWERLINK interface

Interface	Pinout		
	Terminal	POWERLINK	
POWERLINK interface  1 Shielded RJ45 port	1	RXD	Receive signal
	2	RXD\	Receive signal inverted
	3	TXD	Transmit signal
	4	Termination	Termination
	5	Termination	Termination
	6	TXD\	Transmit signal inverted
	7	Termination	Termination
	8	Termination	Termination

6.5.2 USB interface

This Power Panel 65 features a USB 2.0 (Universal Serial Bus) host controller with two USB interfaces that are accessible externally for the user.

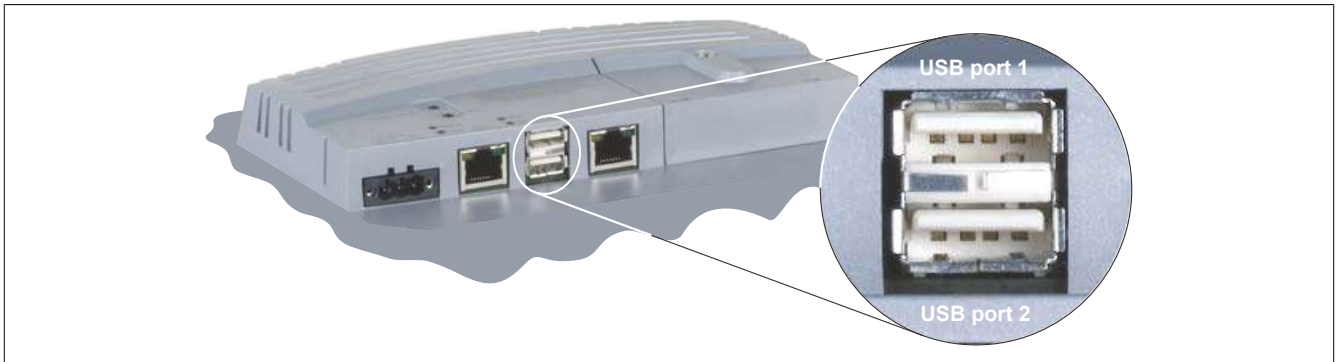

USB interface	
Transfer rate ¹⁾	Low speed (1.5 Mbit/s), full speed (12 Mbit/s), high speed (480 Mbit/s)
Power supply	Max. 0.5 A per port ²⁾

- 1) The actual value depends on the operating system or driver used.
- 2) Each USB interface is protected by a maintenance-free "USB current-limiting switch" (max. 0.5 A).

Warning!

Peripheral USB devices can be connected to the USB interfaces. Due to the large number of USB devices available on the market, B&R cannot guarantee their functionality. Functionality is ensured when using the USB devices available from B&R.

Notice!

Because this interface is designed according to general PC specifications, extreme care should be taken with regard to EMC, wiring, etc.

6.5.3 Ethernet interface

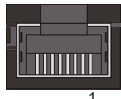
Interface	Pinout		
	Terminal	Ethernet	
Ethernet interface  RJ45 twisted pair female connector (10BaseT / 100BaseT)	1	RXD	Receive signal
	2	RXD\	Receive signal inverted
	3	TXD	Transmit signal
	4	Termination	Termination
	5	Termination	Termination
	6	TXD\	Transmit signal inverted
	7	Termination	Termination
	8	Termination	Termination

6.5.4 Power supply

The pinout is listed in the following table and printed on the back of the Power Panel. The Power Panel has reverse polarity protection that prevents the supply voltage from being connected incorrectly and damaging the device. Overload protection must be provided by an external fuse (5 A, fast-acting).

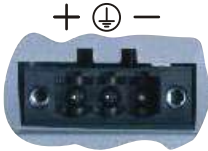
Power supply	Pinout	
	Terminal	Assignment
 3-pin male multipoint connector	+	24 VDC
	⊕	Functional ground
	—	GND
	Required accessories	
0TB103.9	Connector, 24 VDC, 3-pin female, 3.31 mm ² screw clamps, protected against vibration by the screw flange	
0TB103.91	Connector, 24 VDC, 3-pin female, 3.31 mm ² cage clamp terminal block, protected against vibration by the screw flange	

Notice!

The functional ground must be connected to ground (e.g. control cabinet) using the shortest possible path. Using the largest possible conductor cross section on the power supply connector is recommended.

6.6 Operating mode and node number switches

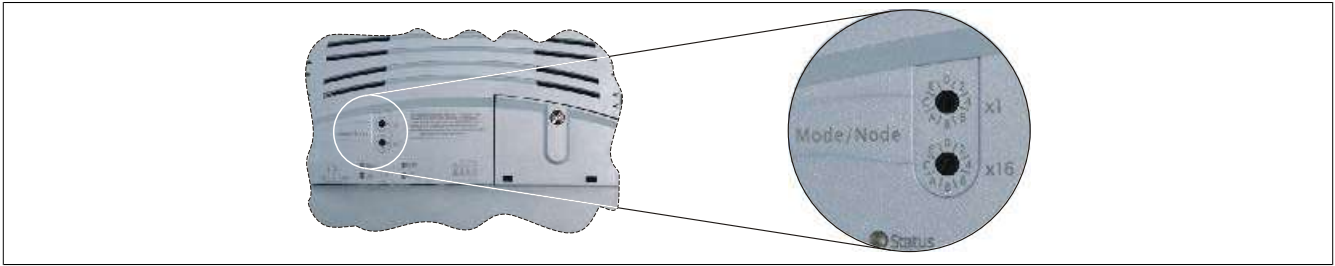

The Power Panel 65 is equipped with 2 hex switches that can be used as operating mode or node number switches. Switch positions 0x01 to 0xFE are used to set the INA node number of the Ethernet interface.

Switch position	Description
0x00	Reserved
0x01 to 0xFE	INA node number of the Ethernet interface
0xFF	Diagnostic mode: Starts up the CPU in diagnostic mode. Does not initialize program sections in User RAM and User FlashPROM. After diagnostic mode, the CPU always starts up with a warm restart.

6.7 Dimensions

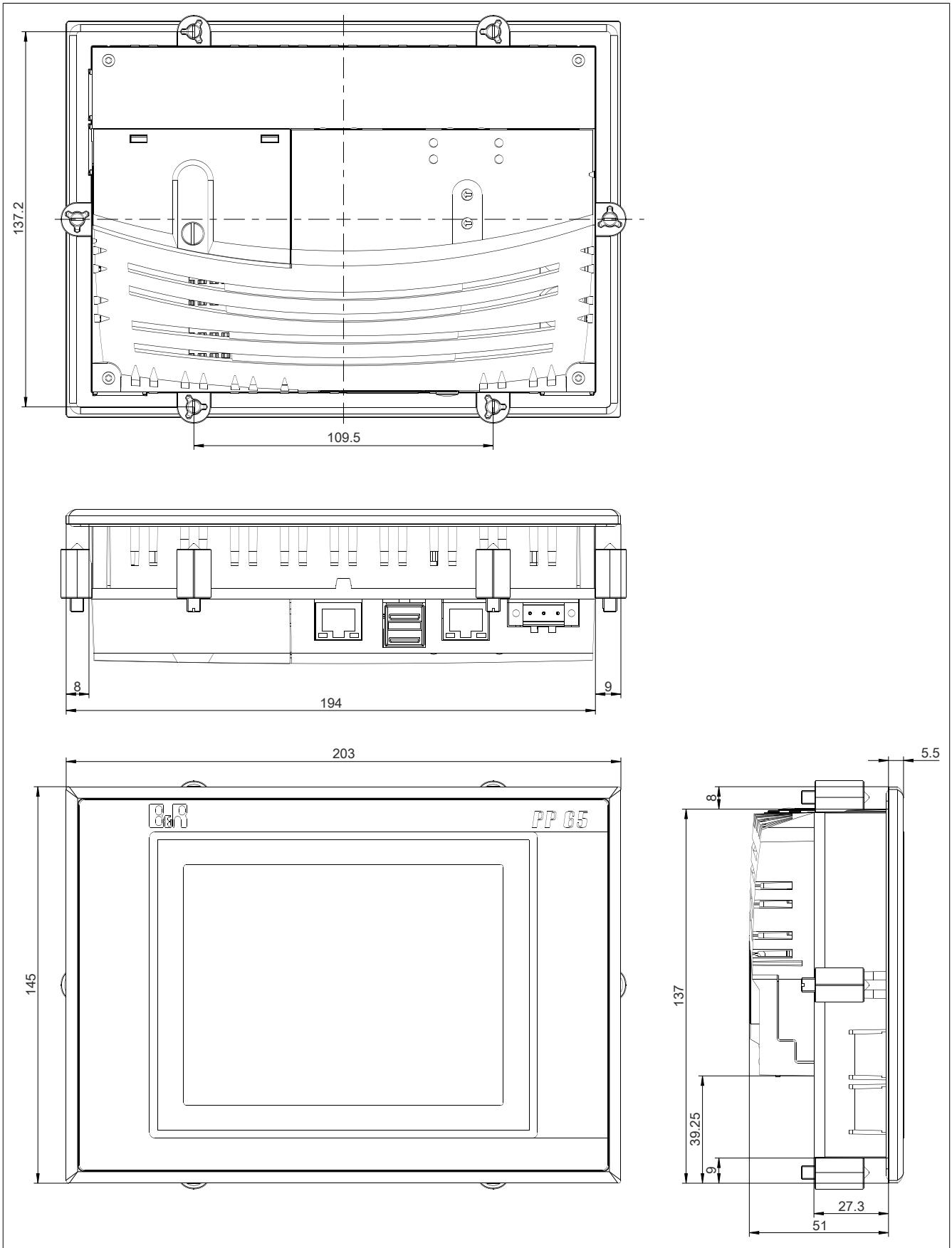

Installation cutout: 188 ±0.5 mm x 130 ±0.5 mm

7 4PP065.0571-X74

7.1 Order data

Model number	Short description	Figure
	Power Panel 65	
4PP065.0571-X74	Power Panel PP65, 5.7" QVGA color TFT display with touch screen (resistive), 128 MB DRAM, 232 kB SRAM, CompactFlash slot, 1x ETH 10/100, 1x X2X Link, 2x USB, IP65 protection (front), order application memory separately Order 0TB103 and 0TB704 terminal blocks separately	
	Required accessories	
	Accessories	
0TB103.9	Connector 24 VDC - 3-pin female - Screw clamp terminal block 3.31 mm ²	
0TB103.91	Connector 24 VDC - 3-pin, female - Cage clamp terminal block 3.31 mm ²	
	CompactFlash cards	
0CFCRD.0512E.01	CompactFlash 512 MB extended temp.	
0CFCRD.2048E.01	CompactFlash 2048 MB extended temp.	
5CFCRD.0512-06	CompactFlash 512 MB B&R (SLC)	
5CFCRD.1024-06	CompactFlash 1 GB B&R (SLC)	
5CFCRD.2048-06	CompactFlash 2 GB B&R (SLC)	
5CFCRD.4096-06	CompactFlash 4 GB B&R (SLC)	
	Terminal blocks	
0TB704.9	Accessory terminal block, 4-pin, screw clamp terminal block 2.5 mm ²	
0TB704.91	Accessory terminal block, 4-pin, push-in terminal block 2.5 mm ²	
	Optional accessories	
	Batteries	
0AC201.91	Lithium batteries 4 pcs., 3 V / 950 mAh button cell	
4A0006.00-000	Lithium battery, 3 V / 950 mAh, button cell	
	Interface modules	
4PP065.IF10-1	PP65 interface module, 1 RS232 interface	
4PP065.IF23-1	PP65 interface module, 1 RS232 interface, 1 RS485/RS422 interface, RS422 electrically isolated, RS485 electrically isolated and network-capable, RS232/RS485/RS422 in one connector, 1 CAN interface electrically isolated and network-capable, order 0TB704 terminal block separately	
4PP065.IF24-1	PP65 interface module, 1 PROFIBUS DP slave interface electrically isolated and network-capable, 1 RS232 interface, 1 RS422/RS485 interface, RS422/RS485: electrically isolated and network-capable, RS232/RS422/RS485 in one connector	
4PP065.IF33-1	PP65 interface module, 2 CAN interfaces electrically isolated and network-capable, order 0TB704 terminal block separately	
	USB accessories	
5MMUSB.2048-01	USB 2.0 flash drive 2048 MB B&R	

Table 8: 4PP065.0571-X74 - Order data

7.2 Technical data

Model number	4PP065.0571-X74
General information	
B&R ID code	0xA963
LEDs	
Quantity	4
CF (CompactFlash)	Orange
Status	Red/Green
X2X	Orange
User	Green
Battery	
Type	Renata 950 mAh
Service life	4 years ¹⁾
Removable	Yes, accessible from the outside
Variant	Lithium ion
Backup capacitor	
Buffer time	10 min
Certifications	
CE	Yes
UL	cULus E115267 Industrial control equipment
EAC	Yes

Table 9: 4PP065.0571-X74 - Technical data

Model number	4PP065.0571-X74
Controller	
Bootloader, operating system	
PP65 supported starting with version	Automation Runtime, C2.96
Processor	
Type	Geode LX800, 32-bit x86
Clock frequency	500 MHz
L1 cache	128 kB (64 kB I-cache / 64 kB D-cache)
L2 cache	128 kB
Expanded command set	MMX technology, 3D Now
Floating point unit (FPU)	Yes
Flash	4 MB (for firmware)
Cooling	Passive via heat sink
Mode/Node switches	2, 16 positions each
Remanent variables	32 kB
Watchdog	MTCX ²⁾
Real-time clock	
Accuracy	At 25°C: Typ. 30 ppm (2.5 seconds) per day ³⁾
Battery-backed	Yes
Power failure logic	
Controller	MTCX ²⁾
Buffer time	10 ms
Graphics	
Controller	Geode LX800
Memory	8 MB shared memory (allocated in RAM)
Standard memory	
RAM	128 MB DDR SDRAM
User RAM	232 kB SRAM
PP65 Compact IF slot	1
Display	
Type	TFT color
Diagonal	5.7" (144 mm)
Colors	262,144
Resolution	QVGA, 320 x 240 pixels
Contrast	350:1
Viewing angles	
Horizontal	Direction R / Direction L = 60°
Vertical	Direction U = 65° / Direction D = 50°
Backlight	
Brightness	500 cd/m ²
Half-brightness time	50,000 h
Touch screen	
Technology	Analog, resistive
Controller	B&R, 12-bit
Transmittance	70% ±10%
Screen rotation	Yes (see chapter "Installation", section "Screen rotation")
Interfaces	
CompactFlash slot 1	
Quantity	1
Type	Type I
Variant	Primary IDE device
USB	
Quantity	2
Type	USB 2.0
Variant	Type A
Transfer rate	Low speed (1.5 Mbit/s), full speed (12 Mbit/s), high speed (480 Mbit/s)
Current-carrying capacity	Max. 500 mA per connection
Ethernet	
Quantity	1
Controller	Intel 82551ER
Variant	Shielded RJ45 port (10/100 Base-T)
Transfer rate	10/100 Mbit/s
Max. baud rate	100 Mbit/s
Cables	S/STP (Category 5)
LED status indicators	Link/Activity

Table 9: 4PP065.0571-X74 - Technical data

Model number	4PP065.0571-X74
X2X	
Type	X2X Link master
Quantity	1
Variant	4-pin male multipoint connector
Internal bus power supply	No
Number of stations	Max. 253
Distance between 2 stations	Max. 100 m
Network topology	Line
Terminating resistor	Internal
Electrical properties	
Nominal voltage	24 VDC ±25%
Nominal current	0.45 A
Inrush current	Max. 2.8 A
Power consumption	Typ. 10 W
Galvanic isolation	No
Operating conditions	
Installation elevation above sea level	
0 to 2000 m	No limitation
>2000 m	Reduction of ambient temperature by 0.5°C per 100 m
Degree of protection per EN 60529	Back: IP20 (only with an inserted CompactFlash card) Front: IP65 / NEMA 250 type 4X, dust and sprayed water protection
Ambient conditions	
Temperature	
Operation	0 to 50°C
Storage	-20 to 70°C
Transport	-20 to 70°C
Relative humidity	
Operation	10 to 90%, non-condensing
Storage	T ≤ 40°C: 5 to 90%, non-condensing T > 40°C: <90%, non-condensing
Vibration	
Operation (continuous)	2 to 9 Hz: 1.75 mm amplitude / 9 to 200 Hz: 0.5 g
Operation (occasional)	2 to 9 Hz: 3.5 mm amplitude / 9 to 200 Hz: 1 g
Storage	2 to 8 Hz: 7.5 mm amplitude / 8 to 200 Hz: 2 g / 200 to 500 Hz: 4 g
Transport	2 to 8 Hz: 7.5 mm amplitude / 8 to 200 Hz: 2 g / 200 to 500 Hz: 4 g
Shock	
Operation	15 g, 11 ms
Storage	30 g, 15 ms
Transport	30 g, 15 ms
Mechanical properties	
Housing	
Material	Polyester
Front	Multi-layered panel overlay
Dimensions	
Width	203 mm
Height	145 mm
Depth	56.5 mm
Weight ⁴⁾	0.75 kg

Table 9: 4PP065.0571-X74 - Technical data

- 1) Typical service life (at 50% buffer operation: 25°C when device off, 50°C when device on).
Maximum service life in 24h operation (no buffer): 6 years at 25°C, 5 years at 50°C.
Maximum service life when device switched off: 2 years at 25°C, 1 year at 50°C.
- 2) Maintenance Controller Extended.
- 3) At max. specified ambient temperature: Typ. 50 ppm (4 s); worst case 100 ppm (8 s)
- 4) Weight including fasteners and battery (46.5 g) but without an interface module.

7.3 Supported interface modules



Support for interface modules is provided starting with the following Automation Runtime versions:

Automation Runtime version	Interface modules			
	4PP065.IF10-1	4PP065.IF23-1	4PP065.IF24-1	4PP065.IF33-1
	C2.96	C2.96	A3.07	C2.96

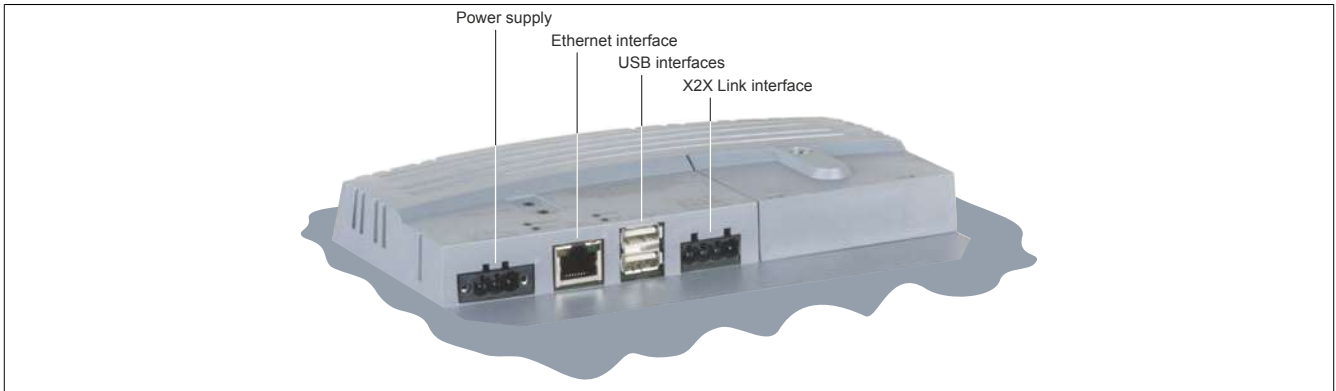
7.5 Connection elements

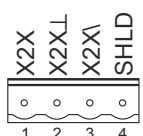

7.5.1 X2X Link interface

Interface	Pinout		
User interface X2X Link   4-pin male multipoint connector	Terminal	X2X Link	
	1	X2X	X2X data
	2	X2X.L	X2X ground
	3	X2X.I	X2X data inverted
	4	SHLD	Shield
Required accessories			
0TB704.9	Accessory terminal block, 4-pin, screw clamp terminal block 2.5 mm ²		
0TB704.91	Accessory terminal block, 4-pin, cage clamp terminal block, 2.5 mm ²		

7.5.2 USB interface

This Power Panel 65 features a USB 2.0 (Universal Serial Bus) host controller with two USB interfaces that are accessible externally for the user.

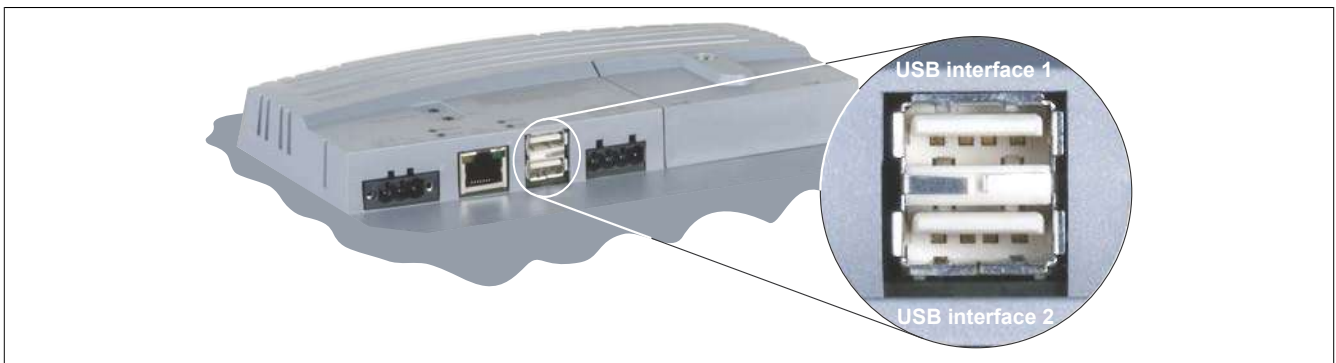

USB interface	
Transfer rate ¹⁾	Low speed (1.5 Mbit/s), full speed (12 Mbit/s), high speed (480 Mbit/s)
Power supply	Max. 0.5 A per port ²⁾

- 1) The actual value depends on the operating system or driver used.
- 2) Each USB interface is protected by a maintenance-free "USB current-limiting switch" (max. 0.5 A).

Warning!

Peripheral USB devices can be connected to the USB interfaces. Due to the large number of USB devices available on the market, B&R cannot guarantee their functionality. Functionality is ensured when using the USB devices available from B&R.

Notice!

Because this interface is designed according to general PC specifications, extreme care should be taken with regard to EMC, wiring, etc.

7.5.3 Ethernet interface

Interface	Pinout		
	Terminal	Ethernet	
Ethernet interface  1 RJ45 twisted pair female connector (10BaseT / 100BaseT)	1	RXD	Receive signal
	2	RXD\	Receive signal inverted
	3	TXD	Transmit signal
	4	Termination	Termination
	5	Termination	Termination
	6	TXD\	Transmit signal inverted
	7	Termination	Termination
	8	Termination	Termination

7.5.4 Power supply

The pinout is listed in the following table and printed on the back of the Power Panel. The Power Panel has reverse polarity protection that prevents the supply voltage from being connected incorrectly and damaging the device. Overload protection must be provided by an external fuse (5 A, fast-acting).

Power supply	Pinout	
	Terminal	Assignment
 3-pin male multipoint connector	+	24 VDC
	⊥	Functional ground
	—	GND
	Required accessories	
0TB103.9	Connector, 24 VDC, 3-pin female, 3.31 mm ² screw clamps, protected against vibration by the screw flange	
0TB103.91	Connector, 24 VDC, 3-pin female, 3.31 mm ² cage clamp terminal block, protected against vibration by the screw flange	

Notice!

The functional ground must be connected to ground (e.g. control cabinet) using the shortest possible path. Using the largest possible conductor cross section on the power supply connector is recommended.

7.6 Operating mode and node number switches

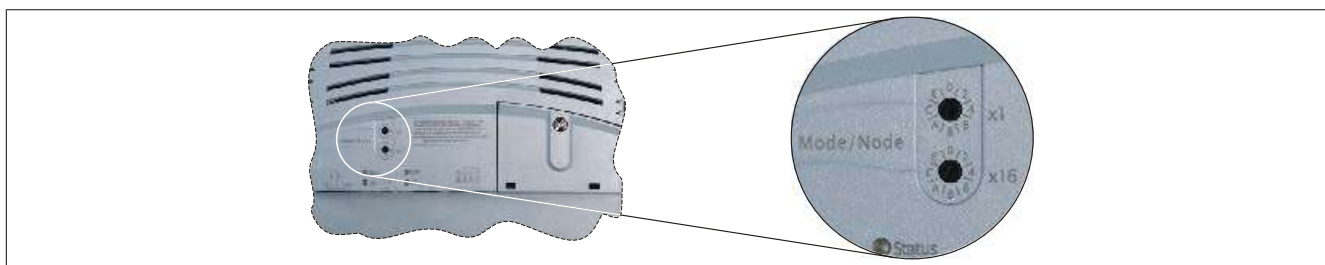

The Power Panel 65 is equipped with 2 hex switches that can be used as operating mode or node number switches. Switch positions 0x01 to 0xFE are used to set the INA node number of the Ethernet interface.

Switch position	Description
0x00	Reserved
0x01 to 0xFE	INA node number of the Ethernet interface
0xFF	Diagnostic mode: Starts up the CPU in diagnostic mode. Does not initialize program sections in User RAM and User FlashPROM. After diagnostic mode, the CPU always starts up with a warm restart.

7.7 Dimensions

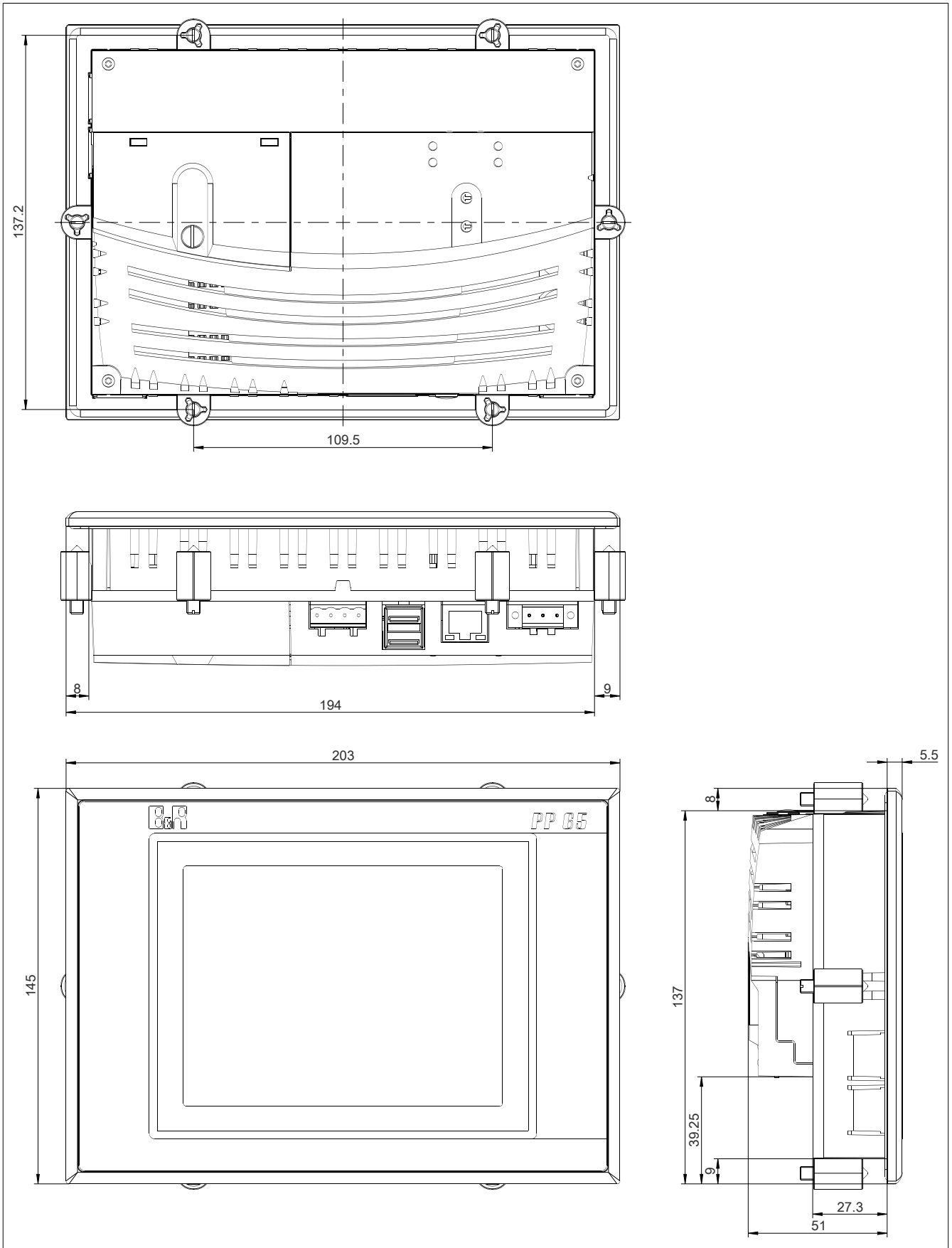

Installation cutout: 188 ±0.5 mm x 130 ±0.5 mm

8 4PP065.0571-P74F

8.1 Order data

Model number	Short description	Figure
	Power Panel 65	
4PP065.0571-P74F	Power Panel PP65, 5.7" QVGA color TFT display with touch screen (resistive), 10 function keys, 128 MB DRAM, 232 kB SRAM, CompactFlash slot, 1x ETH 10/100, 1x POWERLINK, 2x USB, IP65 protection (front), order application memory separately Order 0TB103 terminal block separately	
	Required accessories	
	Accessories	
0TB103.9	Connector 24 VDC - 3-pin female - Screw clamp terminal block 3.31 mm ²	
0TB103.91	Connector 24 VDC - 3-pin, female - Cage clamp terminal block 3.31 mm ²	
	CompactFlash cards	
0CFCRD.0512E.01	CompactFlash 512 MB extended temp.	
0CFCRD.2048E.01	CompactFlash 2048 MB extended temp.	
5CFCRD.0512-06	CompactFlash 512 MB B&R (SLC)	
5CFCRD.1024-06	CompactFlash 1 GB B&R (SLC)	
5CFCRD.2048-06	CompactFlash 2 GB B&R (SLC)	
5CFCRD.4096-06	CompactFlash 4 GB B&R (SLC)	
	Optional accessories	
	Batteries	
0AC201.91	Lithium batteries 4 pcs., 3 V / 950 mAh button cell	
4A0006.00-000	Lithium battery, 3 V / 950 mAh, button cell	
	Interface modules	
4PP065.IF10-1	PP65 interface module, 1 RS232 interface	
4PP065.IF23-1	PP65 interface module, 1 RS232 interface, 1 RS485/RS422 interface, RS422 electrically isolated, RS485 electrically isolated and network-capable, RS232/RS485/RS422 in one connector, 1 CAN interface electrically isolated and network-capable, order 0TB704 terminal block separately	
4PP065.IF24-1	PP65 interface module, 1 PROFIBUS DP slave interface electrically isolated and network-capable, 1 RS232 interface, 1 RS422/RS485 interface, RS422/RS485: electrically isolated and network-capable, RS232/RS422/RS485 in one connector	
4PP065.IF33-1	PP65 interface module, 2 CAN interfaces electrically isolated and network-capable, order 0TB704 terminal block separately	
	Legend strips	
4A0075.00-000	5 piece of DIN A4 legend strips, 16 areas for all in all 40 PP65 5.7" devices, Download the CorelDraw file from the web site.	
	USB accessories	
5MMUSB.2048-01	USB 2.0 flash drive 2048 MB B&R	

Table 10: 4PP065.0571-P74F - Order data

8.2 Technical data

Model number	4PP065.0571-P74F
General information	
B&R ID code	0xB9BD
LEDs	
Quantity	4
CF (CompactFlash)	Orange
Status	Red/Green
EPL (POWERLINK)	Red/Green
User	Green
Battery	
Type	Renata 950 mAh
Service life	4 years ¹⁾
Removable	Yes, accessible from the outside
Variant	Lithium ion
Backup capacitor	
Buffer time	10 min
Certifications	
CE	Yes
UL	cULus E115267
EAC	Industrial control equipment
	Yes
Controller	
Bootloader, operating system	
PP65 supported starting with version	Automation Runtime, A3.01

Table 11: 4PP065.0571-P74F - Technical data

Model number	4PP065.0571-P74F
Processor	
Type	Geode LX800, 32-bit x86
Clock frequency	500 MHz
L1 cache	128 kB (64 kB I-cache / 64 kB D-cache)
L2 cache	128 kB
Expanded command set	MMX technology, 3D Now
Floating point unit (FPU)	Yes
Flash	4 MB (for firmware)
Cooling	Passive via heat sink
Mode/Node switches	2, 16 positions each
Remanent variables	32 kB
Watchdog	MTCX ²⁾
Real-time clock	
Accuracy	At 25°C: Typ. 30 ppm (2.5 seconds) per day ³⁾
Battery-backed	Yes
Power failure logic	
Controller	MTCX ²⁾
Buffer time	10 ms
Graphics	
Controller	Geode LX800
Memory	8 MB shared memory (allocated in RAM)
Standard memory	
RAM	128 MB DDR SDRAM
User RAM	232 kB SRAM
PP65 Compact IF slot	1
Display	
Type	TFT color
Diagonal	5.7" (144 mm)
Colors	262,144
Resolution	QVGA, 320 x 240 pixels
Contrast	350:1
Viewing angles	
Horizontal	Direction R / Direction L = 60°
Vertical	Direction U = 65° / Direction D = 50°
Backlight	
Brightness	500 cd/m ²
Half-brightness time	50,000 h
Touch screen	
Technology	Analog, resistive
Controller	B&R, 12-bit
Transmittance	70% ±10%
Screen rotation	Yes (see chapter "Installation", section "Screen rotation")
Interfaces	
CompactFlash slot 1	
Quantity	1
Type	Type I
Variant	Primary IDE device
USB	
Quantity	2
Type	USB 2.0
Variant	Type A
Transfer rate	Low speed (1.5 Mbit/s), full speed (12 Mbit/s), high speed (480 Mbit/s)
Current-carrying capacity	Max. 500 mA per connection
Ethernet	
Quantity	1
Controller	Intel 82551ER
Variant	Shielded RJ45 port (10/100 Base-T)
Transfer rate	10/100 Mbit/s
Max. baud rate	100 Mbit/s
Cables	S/STP (Category 5)
LED status indicators	Link/Activity
POWERLINK	
Quantity	1
Fieldbus	POWERLINK (V1/V2)
Type	Type 4 ⁴⁾
Variant	Shielded RJ45 port
Transfer rate	100 Mbit/s
Transfer	100 Base-T (ANSI/IEEE 802.3)
Status LED	Link/Activity
Cable length	Max. 100 m between two stations (segment length)
Keys	
Variant	Membrane keypad with metallic snap-action disks

Table 11: 4PP065.0571-P74F - Technical data

Model number		4PP065.0571-P74F
Total keys	10 membrane keys	
Function keys	10 (with slide-in labels)	
Service life	> 10 ⁶ actuations with 1 ±0.3 to 3 ±0.3 N operating force	
Electrical properties		
Nominal voltage	24 VDC ±25%	
Nominal current	0.45 A	
Inrush current	Max. 2.8 A	
Power consumption	Typ. 10 W	
Galvanic isolation	No	
Operating conditions		
Installation elevation above sea level	No limitation	
0 to 2000 m	No limitation	
>2000 m	Reduction of ambient temperature by 0.5°C per 100 m	
Degree of protection per EN 60529	Back: IP20 (only with an inserted CompactFlash card) Front: IP65 / NEMA 250 type 4X, dust and sprayed water protection	
Ambient conditions		
Temperature		
Operation	0 to 50°C	
Storage	-20 to 70°C	
Transport	-20 to 70°C	
Relative humidity		
Operation	10 to 90%, non-condensing	
Storage	T ≤ 40°C: 5 to 90%, non-condensing T > 40°C: <90%, non-condensing	
Vibration		
Operation (continuous)	2 to 9 Hz: 1.75 mm amplitude / 9 to 200 Hz: 0.5 g	
Operation (occasional)	2 to 9 Hz: 3.5 mm amplitude / 9 to 200 Hz: 1 g	
Storage	2 to 8 Hz: 7.5 mm amplitude / 8 to 200 Hz: 2 g / 200 to 500 Hz: 4 g	
Transport	2 to 8 Hz: 7.5 mm amplitude / 8 to 200 Hz: 2 g / 200 to 500 Hz: 4 g	
Shock		
Operation	15 g, 11 ms	
Storage	30 g, 15 ms	
Transport	30 g, 15 ms	
Mechanical properties		
Housing		
Material	Polyester	
Front	Multi-layered panel overlay with insertion slots for key labels	
Dimensions		
Width	203 mm	
Height	145 mm	
Depth	56.5 mm	
Weight ⁵⁾	0.75 kg	

Table 11: 4PP065.0571-P74F - Technical data

- 1) Typical service life (at 50% buffer operation: 25°C when device off, 50°C when device on).
Maximum service life in 24h operation (no buffer): 6 years at 25°C, 5 years at 50°C.
Maximum service life when device switched off: 2 years at 25°C, 1 year at 50°C.
- 2) Maintenance Controller Extended.
- 3) At max. specified ambient temperature: Typ. 50 ppm (4 s); worst case 100 ppm (8 s)
- 4) See the help system in Automation Studio under "Communication / POWERLINK / General information / Hardware - IF/LS".
- 5) Weight including fasteners and battery (46.5 g) but without an interface module.

8.3 Supported interface modules

Support for interface modules is provided starting with the following Automation Runtime versions:

	Interface modules			
	4PP065.IF10-1	4PP065.IF23-1	4PP065.IF24-1	4PP065.IF33-1
Automation Runtime version	A3.01	A3.01	A3.07	A3.01

8.4 Diagnostic LEDs

There are four diagnostic LEDs on the back of the PP65.

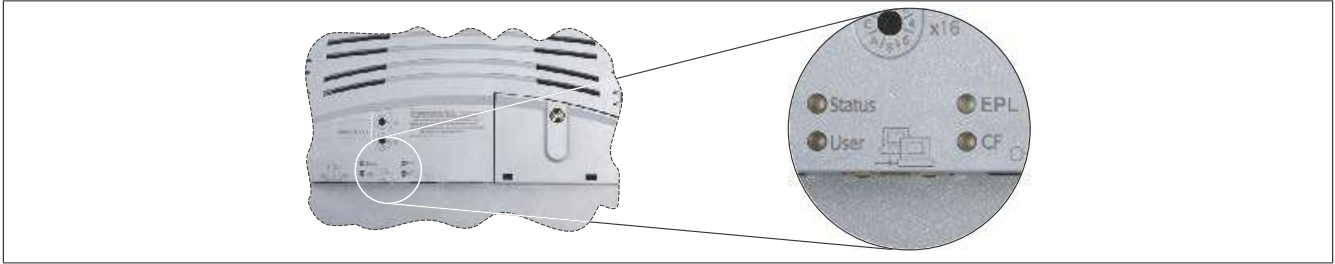

Information:

The behavior of the Status LED has changed starting with AR J2.96, E3.01 and B3.06.

8.4.1 Diagnostic LEDs up to AR I2.96, D3.01 and A3.06

LED	Color	Status	Description
Status	Red	On	Error/Reset
	Orange	On	Boot or Ready mode
User	Green	On/Off	LED operable by the user (with the AsHW library)
EPL	See "EPL LED" on page 55.		
CF	Orange	On	CompactFlash card being accessed

8.4.2 Diagnostic LEDs starting with AR J2.96, E3.01 and B3.06

LED	Color	Status	Description
Status	see following table "Status LED blink codes"		
User	Green	On/Off	LED operable by the user (with the AsHW library)
EPL	See "EPL LED" on page 55.		
CF	Orange	On	CompactFlash card being accessed

Status LED blink codes

Blink codes (200 ms pattern)	Function
Red	Error/Reset
Green	No errors, normal operation
Orange	Battery not installed or battery capacity too low
Green	CompactFlash media not found
Reserved	Reserved for future blink codes

Because blink codes can only signal one error at a time, errors with higher priority take precedence. Fatal errors have a higher priority than less significant errors (e.g. low battery capacity).

8.4.3 EPL LED

The EPL LED is a green (Status) / red (Error) dual LED. The status of the LEDs has different meanings depending on the operating mode (Ethernet TCP/IP mode, POWERLINK V1 or POWERLINK V2).

Ethernet TCP/IP mode

The POWERLINK interface can be operated purely as an Ethernet TCP/IP interface.

Green - Status	Description
On	POWERLINK interface operating purely as an Ethernet TCP/IP interface

POWERLINK V1

EPL LED		Status of the POWERLINK station
Green	Red	
On	Off	The POWERLINK station is running with no errors.
Off	On	A fatal system error has occurred. The error type can be read using the PLC logbook. An irreparable problem has occurred. The system cannot properly carry out its tasks. This state can only be changed by resetting the module.
Blinking alternately		The POWERLINK managing node has failed. This error code can only occur when operated as a controlled node. This means that the configured station number lies within the range 0x01 - 0xFD.
Off	Blink code	System error: The red blinking LED signals an error code (see "System failure error codes" on page 57).

POWERLINK V2

Red - Error	Description
On	<p>The POWERLINK interface is in an error state (failed Ethernet frames, increased number of collisions on the network, etc.).</p> <p>If an error occurs in the following statuses, then the green LED blinks over the red LED:</p> <ul style="list-style-type: none"> • BASIC_ETHERNET • PRE_OPERATIONAL_1 • PRE_OPERATIONAL_2 • READY_TO_OPERATE <p>Example:</p>
Green - Status	Description
Off NOT_ACTIVE	<p>Managing Node (MN) The bus is monitored for POWERLINK frames. If a frame is not received within the configured time window (timeout), the interface switches immediately to the PRE_OPERATIONAL_1 state (single flash). If, however, POWERLINK communication is detected before this time passes, the interface goes directly into the BASIC_ETHERNET state (flickering).</p> <p>Controlled node (CN) The bus is monitored for POWERLINK frames. If a frame is not received within the configured time window (timeout), the interface switches immediately to the BASIC_ETHERNET state (flickering). If POWERLINK communication is detected before this time expires, however, the interface switches immediately to the PRE_OPERATIONAL_1 state (single flash).</p>
Flickering green (approx. 10 Hz) BASIC_ETHERNET	<p>The interface is in the BASIC_ETHERNET state and being operated purely as an Ethernet TCP/IP interface.</p> <p>Managing node (MN) This state can only be exited by resetting the interface.</p> <p>Controlled node (CN) If POWERLINK communication is detected while in this state, the interface switches to the PRE_OPERATIONAL_1 state (single flash). In this status, a lit red LED indicates a manager error.</p>
Single flash (approx. 1 Hz) PRE_OPERATIONAL_1	<p>The interface status is in the PRE_OPERATIONAL_1 state.</p> <p>Managing node (MN) The MN starts "reduced cycle" operation. Collisions are allowed on the bus. Cyclic communication is not yet taking place.</p> <p>Controlled node (CN) The CN waits until it receives an SoC frame and then switches to the PRE_OPERATIONAL_2 state (double flash). In this status, a lit red LED indicates a manager error.</p>
Double flash (approx. 1 Hz) PRE_OPERATIONAL_2	<p>The interface is in the PRE_OPERATIONAL_2 state.</p> <p>Managing node (MN) The MN begins cyclic communication (cyclic input data is not yet being evaluated). The CNs are configured in this state.</p> <p>Controlled node (CN) The interface is normally configured by the manager in this state. A command then switches the state to READY_TO_OPERATE (triple flash). In this status, a lit red LED indicates a manager error.</p>
Triple flash (approx. 1 Hz) READY_TO_OPERATE	<p>The interface is in the READY_TO_OPERATE state.</p> <p>Managing node (MN) Cyclic and asynchronous communication is taking place. Received PDO data is ignored.</p> <p>Controlled node (CN) The configuration of the interface is complete. Normal cyclic and asynchronous communication is taking place. The PDO data sent corresponds to the PDO mapping. Cyclic data is not yet being evaluated, however. In this status, a lit red LED indicates a manager error.</p>
On OPERATIONAL	<p>The interface is in the OPERATIONAL state.</p>
Blinking (approx. 2.5 Hz) STOPPED	<p>The interface is in the STOPPED state.</p> <p>Managing node (MN) This status is not possible for the MN.</p> <p>Controlled node (CN) No output data is being produced, and no input data is being received. It is only possible to switch to or leave this state after the manager has given the appropriate command.</p>

System failure error codes

Incorrect configuration or defective hardware can cause a system failure error. The error code is indicated by the red EPL Error LED using four switch-on phases. Each switch-on phase has a duration of either 150 ms or 600 ms. The error code is repeated every 2 seconds.

Key

- ... 150 ms
- ... 600 ms
- Pause ... 2 second delay

Error description	Error code displayed by red EPL LED									
RAM error	•	•	•	-	Pause	•	•	•	-	Pause
Hardware error	-	•	•	-	Pause	-	•	•	-	Pause

8.4.4 ACT / LNK LEDs for the RJ45 interfaces

There are two additional LEDs each for the Ethernet and POWERLINK interfaces.

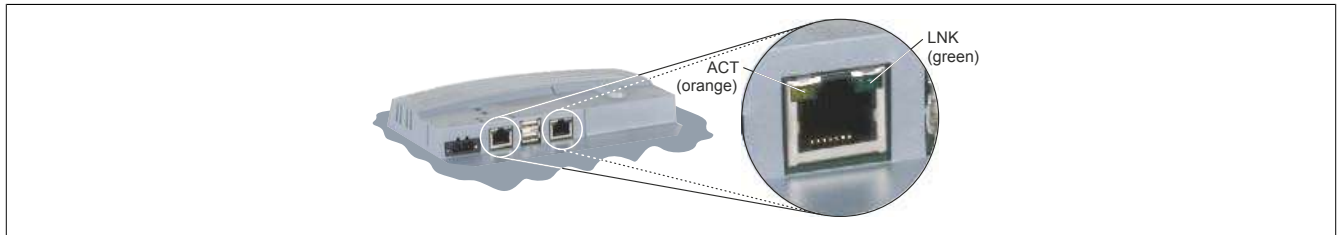

LED	Color	Status	Description
ACT	Orange	On	No Ethernet or POWERLINK activity on the bus
		Blinking	Ethernet or POWERLINK activity on the bus
LNK	Green	On	Link established to the remote station

8.5 Connection elements

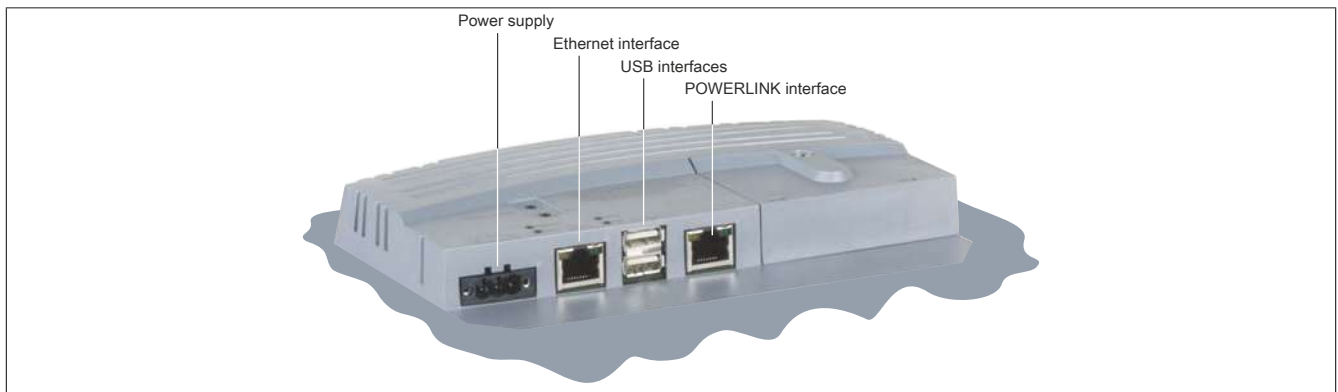

8.5.1 POWERLINK interface

Interface	Pinout		
	Terminal	POWERLINK	
POWERLINK interface Shielded RJ45 port	1	RXD	Receive signal
	2	RXD\	Receive signal inverted
	3	TXD	Transmit signal
	4	Termination	Termination
	5	Termination	Termination
	6	TXD\	Transmit signal inverted
	7	Termination	Termination
	8	Termination	Termination

8.5.2 USB interface

This Power Panel 65 features a USB 2.0 (Universal Serial Bus) host controller with two USB interfaces that are accessible externally for the user.

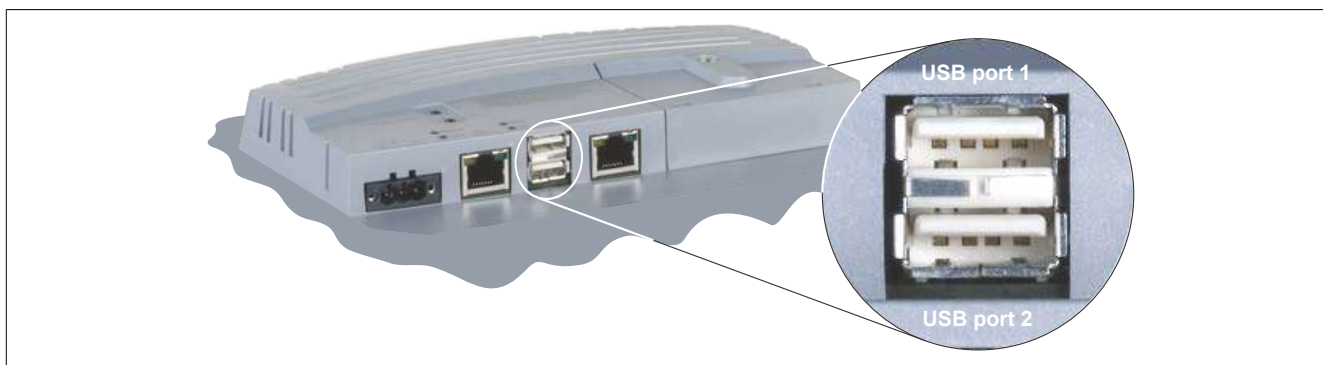

USB interface	
Transfer rate ¹⁾	Low speed (1.5 Mbit/s), full speed (12 Mbit/s), high speed (480 Mbit/s)
Power supply	Max. 0.5 A per port ²⁾

- 1) The actual value depends on the operating system or driver used.
- 2) Each USB interface is protected by a maintenance-free "USB current-limiting switch" (max. 0.5 A).

Warning!

Peripheral USB devices can be connected to the USB interfaces. Due to the large number of USB devices available on the market, B&R cannot guarantee their functionality. Functionality is ensured when using the USB devices available from B&R.

Notice!

Because this interface is designed according to general PC specifications, extreme care should be taken with regard to EMC, wiring, etc.

8.5.3 Ethernet interface

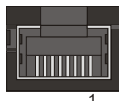
Interface	Pinout		
	Terminal	Ethernet	
Ethernet interface  RJ45 twisted pair female connector (10BaseT / 100BaseT)	1	RXD	Receive signal
	2	RXD\	Receive signal inverted
	3	TXD	Transmit signal
	4	Termination	Termination
	5	Termination	Termination
	6	TXD\	Transmit signal inverted
	7	Termination	Termination
	8	Termination	Termination

8.5.4 Power supply

The pinout is listed in the following table and printed on the back of the Power Panel. The Power Panel has reverse polarity protection that prevents the supply voltage from being connected incorrectly and damaging the device. Overload protection must be provided by an external fuse (5 A, fast-acting).

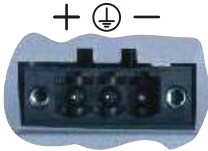
Power supply	Pinout	
	Terminal	Assignment
 3-pin male multipoint connector	+	24 VDC
	⊕	Functional ground
	-	GND
	Required accessories	
0TB103.9	Connector, 24 VDC, 3-pin female, 3.31 mm ² screw clamps, protected against vibration by the screw flange	
0TB103.91	Connector, 24 VDC, 3-pin female, 3.31 mm ² cage clamp terminal block, protected against vibration by the screw flange	

Notice!

The functional ground must be connected to ground (e.g. control cabinet) using the shortest possible path. Using the largest possible conductor cross section on the power supply connector is recommended.

8.6 Key assignments



Key	Bit	Key	Bit
T1	31	T6	23
T2	30	T7	22
T3	29	T8	21
T4	28	T9	20
T5	24	T10	16

8.7 Operating mode and node number switches

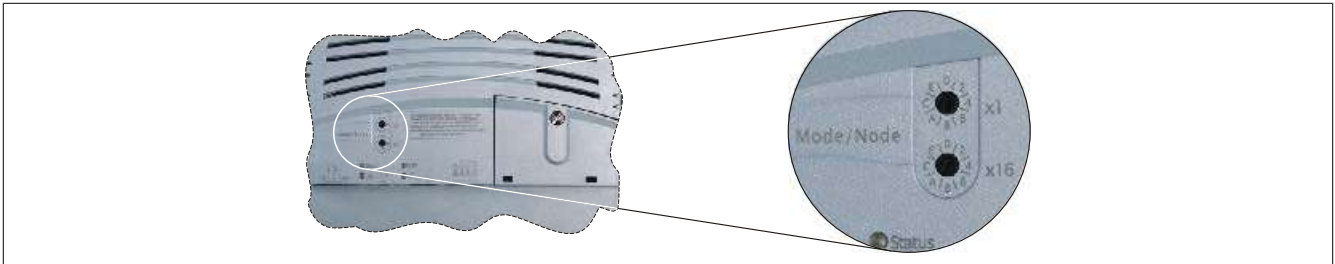

The Power Panel 65 is equipped with 2 hex switches that can be used as operating mode or node number switches. Switch positions 0x01 to 0xFE are used to set the INA node number of the Ethernet interface.

Switch position	Description
0x00	Reserved
0x01 to 0xFE	INA node number of the Ethernet interface
0xFF	Diagnostic mode: Starts up the CPU in diagnostic mode. Does not initialize program sections in User RAM and User FlashPROM. After diagnostic mode, the CPU always starts up with a warm restart.

8.8 Dimensions

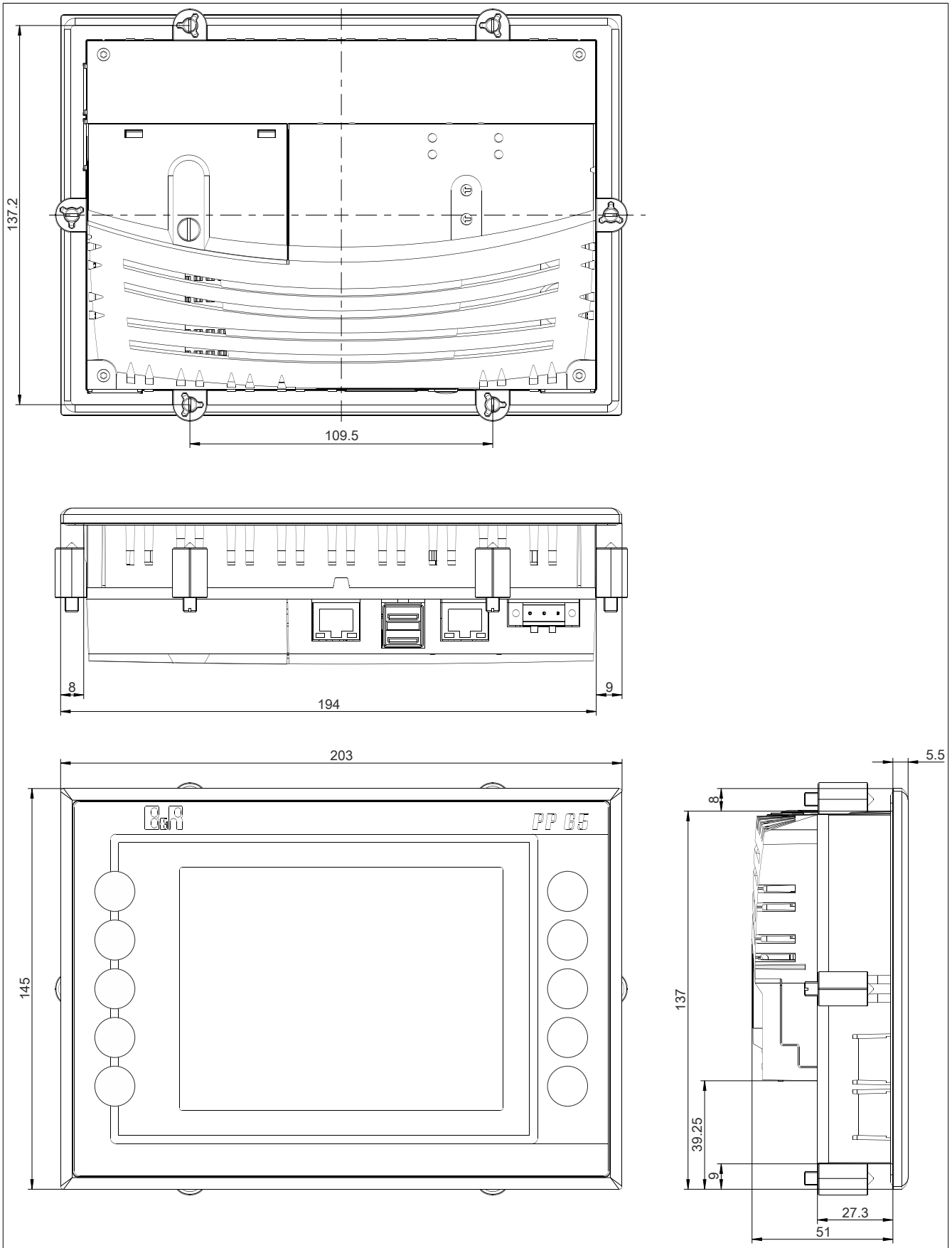

Installation cutout: 188 ±0.5 mm x 130 ±0.5 mm

9 4PP065.0571-X74F

9.1 Order data

Model number	Short description	Figure
	Power Panel 65	
4PP065.0571-X74F	Power Panel PP65, 5.7" QVGA color TFT display with touch screen (resistive), 10 function keys, 128 MB DRAM, 232 kB SRAM, CompactFlash slot, 1x ETH 10/100, 1x X2X Link, 2x USB, IP65 protection (front), order application memory separately Order OTB103 and OTB704 terminal blocks separately	
	Required accessories	
	Accessories	
0TB103.9	Connector 24 VDC - 3-pin female - Screw clamp terminal block 3.31 mm ²	
0TB103.91	Connector 24 VDC - 3-pin, female - Cage clamp terminal block 3.31 mm ²	
	CompactFlash cards	
0CFCRD.0512E.01	CompactFlash 512 MB extended temp.	
0CFCRD.2048E.01	CompactFlash 2048 MB extended temp.	
5CFCRD.0512-06	CompactFlash 512 MB B&R (SLC)	
5CFCRD.1024-06	CompactFlash 1 GB B&R (SLC)	
5CFCRD.2048-06	CompactFlash 2 GB B&R (SLC)	
5CFCRD.4096-06	CompactFlash 4 GB B&R (SLC)	
	Terminal blocks	
0TB704.9	Accessory terminal block, 4-pin, screw clamp terminal block 2.5 mm ²	
0TB704.91	Accessory terminal block, 4-pin, push-in terminal block 2.5 mm ²	
	Optional accessories	
	Batteries	
0AC201.91	Lithium batteries 4 pcs., 3 V / 950 mAh button cell	
4A0006.00-000	Lithium battery, 3 V / 950 mAh, button cell	
	Interface modules	
4PP065.IF10-1	PP65 interface module, 1 RS232 interface	
4PP065.IF23-1	PP65 interface module, 1 RS232 interface, 1 RS485/RS422 interface, RS422 electrically isolated, RS485 electrically isolated and network-capable, RS232/RS485/RS422 in one connector, 1 CAN interface electrically isolated and network-capable, order 0TB704 terminal block separately	
4PP065.IF24-1	PP65 interface module, 1 PROFIBUS DP slave interface electrically isolated and network-capable, 1 RS232 interface, 1 RS422/RS485 interface, RS422/RS485: electrically isolated and network-capable, RS232/RS422/RS485 in one connector	
4PP065.IF33-1	PP65 interface module, 2 CAN interfaces electrically isolated and network-capable, order 0TB704 terminal block separately	
	Legend strips	
4A0075.00-000	5 piece of DIN A4 legend strips, 16 areas for all in all 40 PP65 5.7" devices, Download the CorelDraw file from the web site.	
	USB accessories	
5MMUSB.2048-01	USB 2.0 flash drive 2048 MB B&R	

Table 12: 4PP065.0571-X74F - Order data

9.2 Technical data

Model number	4PP065.0571-X74F
General information	
B&R ID code	0xB9BC
LEDs	
Quantity	4
CF (CompactFlash)	Orange
Status	Red/Green
X2X	Orange
User	Green
Battery	
Type	Renata 950 mAh
Service life	4 years ¹⁾
Removable	Yes, accessible from the outside
Variant	Lithium ion
Backup capacitor	
Buffer time	10 min

Table 13: 4PP065.0571-X74F - Technical data

Model number	4PP065.0571-X74F
Certifications	
CE	Yes
UL	cULus E115267 Industrial control equipment
EAC	Yes
Controller	
Bootloader, operating system	
PP65 supported starting with version	Automation Runtime, C2.96
Processor	
Type	Geode LX800, 32-bit x86
Clock frequency	500 MHz
L1 cache	128 kB (64 kB I-cache / 64 kB D-cache)
L2 cache	128 kB
Expanded command set	MMX technology, 3D Now
Floating point unit (FPU)	Yes
Flash	4 MB (for firmware)
Cooling	Passive via heat sink
Mode/Node switches	2, 16 positions each
Remanent variables	32 kB
Watchdog	MTCX ²⁾
Real-time clock	
Accuracy	At 25°C: Typ. 30 ppm (2.5 seconds) per day ³⁾
Battery-backed	Yes
Power failure logic	
Controller	MTCX ²⁾
Buffer time	10 ms
Graphics	
Controller	Geode LX800
Memory	8 MB shared memory (allocated in RAM)
Standard memory	
RAM	128 MB DDR SDRAM
User RAM	232 kB SRAM
PP65 Compact IF slot	1
Display	
Type	TFT color
Diagonal	5.7" (144 mm)
Colors	262,144
Resolution	QVGA, 320 x 240 pixels
Contrast	350:1
Viewing angles	
Horizontal	Direction R / Direction L = 60°
Vertical	Direction U = 65° / Direction D = 50°
Backlight	
Brightness	500 cd/m ²
Half-brightness time	50,000 h
Touch screen	
Technology	Analog, resistive
Controller	B&R, 12-bit
Transmittance	70% ±10%
Screen rotation	Yes (see chapter "Installation", section "Screen rotation")
Interfaces	
CompactFlash slot 1	
Quantity	1
Type	Type I
Variant	Primary IDE device
USB	
Quantity	2
Type	USB 2.0
Variant	Type A
Transfer rate	Low speed (1.5 Mbit/s), full speed (12 Mbit/s), high speed (480 Mbit/s)
Current-carrying capacity	Max. 500 mA per connection
Ethernet	
Quantity	1
Controller	Intel 82551ER
Variant	Shielded RJ45 port (10/100 Base-T)
Transfer rate	10/100 Mbit/s
Max. baud rate	100 Mbit/s
Cables	S/STP (Category 5)
LED status indicators	Link/Activity

Table 13: 4PP065.0571-X74F - Technical data

Model number	4PP065.0571-X74F
X2X	
Type	X2X Link master
Quantity	1
Variant	4-pin male multipoint connector
Internal bus power supply	No
Number of stations	Max. 253
Distance between 2 stations	Max. 100 m
Network topology	Line
Terminating resistor	Internal
Keys	
Variant	Membrane keypad with metallic snap-action disks
Total keys	10 membrane keys
Function keys	10 (with slide-in labels)
Service life	> 10 ⁶ actuations with 1 ±0.3 to 3 ±0.3 N operating force
Electrical properties	
Nominal voltage	24 VDC ±25%
Nominal current	0.45 A
Inrush current	Max. 2.8 A
Power consumption	Typ. 10 W
Galvanic isolation	No
Operating conditions	
Installation elevation above sea level	
0 to 2000 m	No limitation
>2000 m	Reduction of ambient temperature by 0.5°C per 100 m
Degree of protection per EN 60529	Back: IP20 (only with an inserted CompactFlash card) Front: IP65 / NEMA 250 type 4X, dust and sprayed water protection
Ambient conditions	
Temperature	
Operation	0 to 50°C
Storage	-20 to 70°C
Transport	-20 to 70°C
Relative humidity	
Operation	10 to 90%, non-condensing
Storage	T ≤ 40°C: 5 to 90%, non-condensing T > 40°C: <90%, non-condensing
Vibration	
Operation (continuous)	2 to 9 Hz: 1.75 mm amplitude / 9 to 200 Hz: 0.5 g
Operation (occasional)	2 to 9 Hz: 3.5 mm amplitude / 9 to 200 Hz: 1 g
Storage	2 to 8 Hz: 7.5 mm amplitude / 8 to 200 Hz: 2 g / 200 to 500 Hz: 4 g
Transport	2 to 8 Hz: 7.5 mm amplitude / 8 to 200 Hz: 2 g / 200 to 500 Hz: 4 g
Shock	
Operation	15 g, 11 ms
Storage	30 g, 15 ms
Transport	30 g, 15 ms
Mechanical properties	
Housing	
Material	Polyester
Front	Multi-layered panel overlay with insertion slots for key labels
Dimensions	
Width	203 mm
Height	145 mm
Depth	56.5 mm
Weight ⁴⁾	0.75 kg

Table 13: 4PP065.0571-X74F - Technical data

- 1) Typical service life (at 50% buffer operation: 25°C when device off, 50°C when device on).
Maximum service life in 24h operation (no buffer): 6 years at 25°C, 5 years at 50°C.
Maximum service life when device switched off: 2 years at 25°C, 1 year at 50°C.
- 2) Maintenance Controller Extended.
- 3) At max. specified ambient temperature: Typ. 50 ppm (4 s); worst case 100 ppm (8 s)
- 4) Weight including fasteners and battery (46.5 g) but without an interface module.

9.3 Supported interface modules

Support for interface modules is provided starting with the following Automation Runtime versions:

	Interface modules			
	4PP065.IF10-1	4PP065.IF23-1	4PP065.IF24-1	4PP065.IF33-1
Automation Runtime version	C2.96	C2.96	A3.07	C2.96

9.4 Diagnostic LEDs

There are four diagnostic LEDs on the back of the PP65.

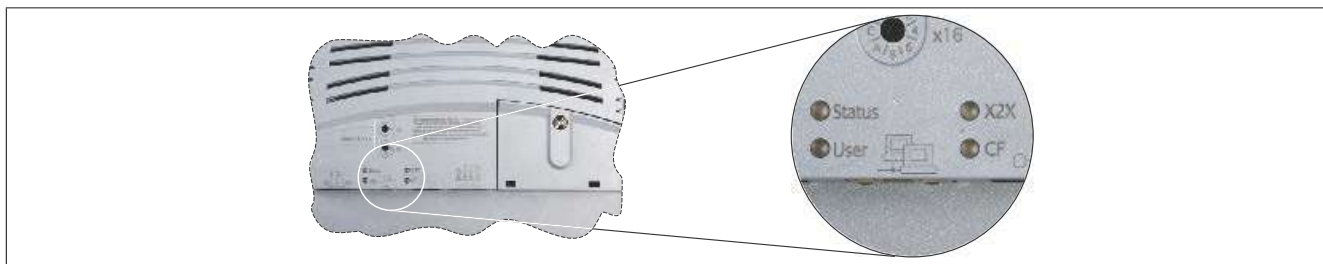

Information:

The behavior of the Status LED has changed starting with AR J2.96, E3.01 and B3.06.

9.4.1 Diagnostic LEDs up to AR I2.96, D3.01 and A3.06

LED	Color	Status	Description
Status	Red	On	Error/Reset
	Orange	On	Boot or Ready mode
User	Green	On/Off	LED operable by the user (with the AsHW library)
X2X	Orange	On	Module sending data via the X2X Link interface
CF	Orange	On	CompactFlash card being accessed

9.4.2 Diagnostic LEDs starting with AR J2.96, E3.01 and B3.06

LED	Color	Status	Description
Status	see following table "Status LED blink codes"		
User	Green	On/Off	LED operable by the user (with the AsHW library)
X2X	Orange	On	Module sending data via the X2X Link interface
CF	Orange	On	CompactFlash card being accessed

Status LED blink codes

Blink codes (200 ms pattern)	Function
Red	Error/Reset
Green	No errors, normal operation
Orange	Battery not installed or battery capacity too low
Green	CompactFlash media not found
Reserved	Reserved for future blink codes

Because blink codes can only signal one error at a time, errors with higher priority take precedence. Fatal errors have a higher priority than less significant errors (e.g. low battery capacity).

9.4.3 ACT / LNK LEDs for the RJ45 interface

There are two additional LEDs for the Ethernet interface.

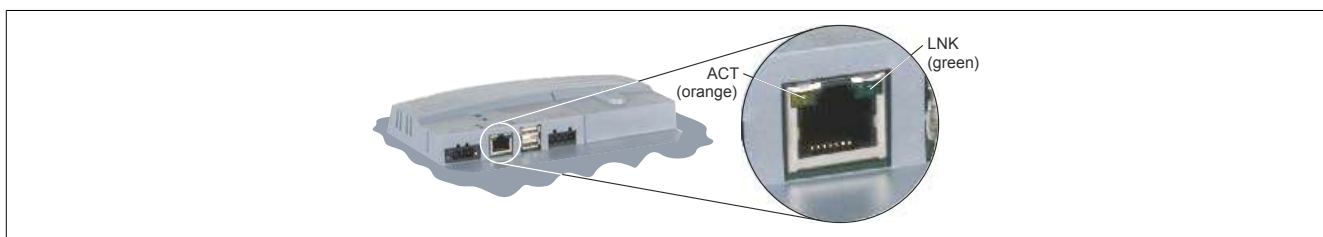

LED	Color	Status	Description
ACT	Orange	On	No Ethernet activity on the bus.
		Blinking	Ethernet activity on the bus.
LNK	Green	On	Link established to the remote station

9.5 Connection elements

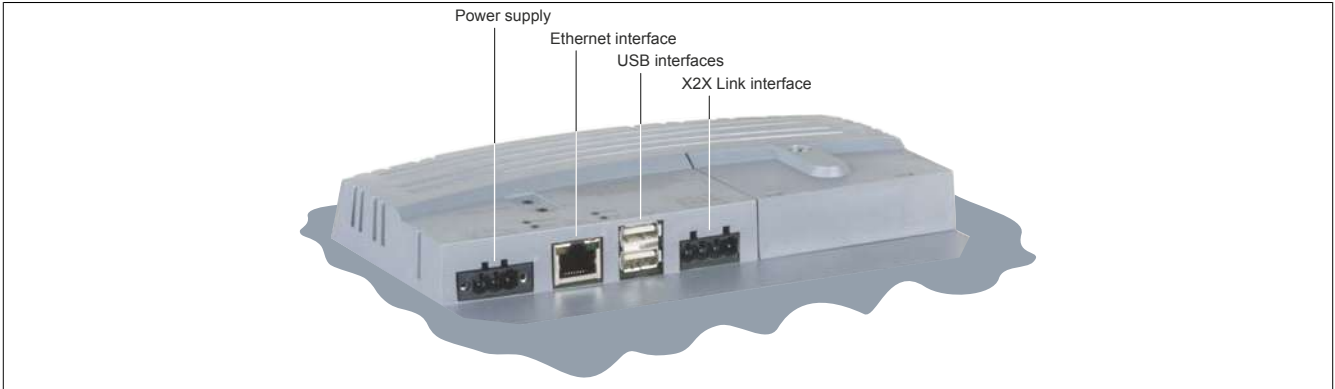

9.5.1 X2X Link interface

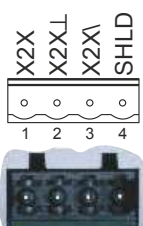
Interface	Pinout		
User interface X2X Link  4-pin male multipoint connector	Terminal	X2X Link	
	1	X2X	X2X data
	2	X2X.L	X2X ground
	3	X2X.I	X2X data inverted
	4	SHLD	Shield
Required accessories			
0TB704.9	Accessory terminal block, 4-pin, screw clamp terminal block 2.5 mm ²		
0TB704.91	Accessory terminal block, 4-pin, cage clamp terminal block, 2.5 mm ²		

9.5.2 USB interface

This Power Panel 65 features a USB 2.0 (Universal Serial Bus) host controller with two USB interfaces that are accessible externally for the user.

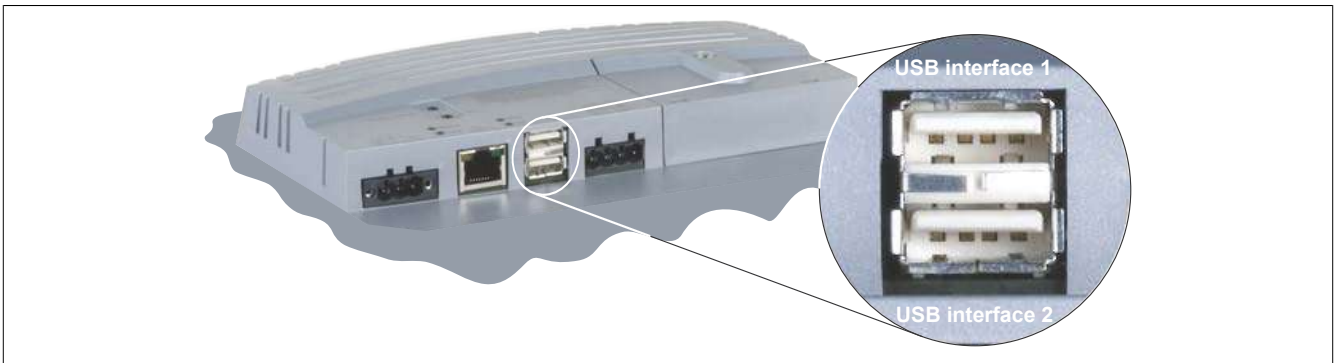

USB interface	
Transfer rate ¹⁾	Low speed (1.5 Mbit/s), full speed (12 Mbit/s), high speed (480 Mbit/s)
Power supply	Max. 0.5 A per port ²⁾

- 1) The actual value depends on the operating system or driver used.
- 2) Each USB interface is protected by a maintenance-free "USB current-limiting switch" (max. 0.5 A).

Warning!

Peripheral USB devices can be connected to the USB interfaces. Due to the large number of USB devices available on the market, B&R cannot guarantee their functionality. Functionality is ensured when using the USB devices available from B&R.

Notice!

Because this interface is designed according to general PC specifications, extreme care should be taken with regard to EMC, wiring, etc.

9.5.3 Ethernet interface

Interface	Pinout		
	Terminal	Ethernet	
Ethernet interface  1 RJ45 twisted pair female connector (10BaseT / 100BaseT)	1	RXD	Receive signal
	2	RXD\	Receive signal inverted
	3	TXD	Transmit signal
	4	Termination	Termination
	5	Termination	Termination
	6	TXD\	Transmit signal inverted
	7	Termination	Termination
	8	Termination	Termination

9.5.4 Power supply

The pinout is listed in the following table and printed on the back of the Power Panel. The Power Panel has reverse polarity protection that prevents the supply voltage from being connected incorrectly and damaging the device. Overload protection must be provided by an external fuse (5 A, fast-acting).

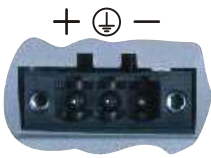
Power supply	Pinout	
	Terminal	Assignment
 3-pin male multipoint connector	+	24 VDC
	⊥	Functional ground
	—	GND
	Required accessories	
0TB103.9	Connector, 24 VDC, 3-pin female, 3.31 mm ² screw clamps, protected against vibration by the screw flange	
0TB103.91	Connector, 24 VDC, 3-pin female, 3.31 mm ² cage clamp terminal block, protected against vibration by the screw flange	

Notice!

The functional ground must be connected to ground (e.g. control cabinet) using the shortest possible path. Using the largest possible conductor cross section on the power supply connector is recommended.

9.6 Key assignments



Key	Bit	Key	Bit
T1	31	T6	23
T2	30	T7	22
T3	29	T8	21
T4	28	T9	20
T5	24	T10	16

9.7 Operating mode and node number switches

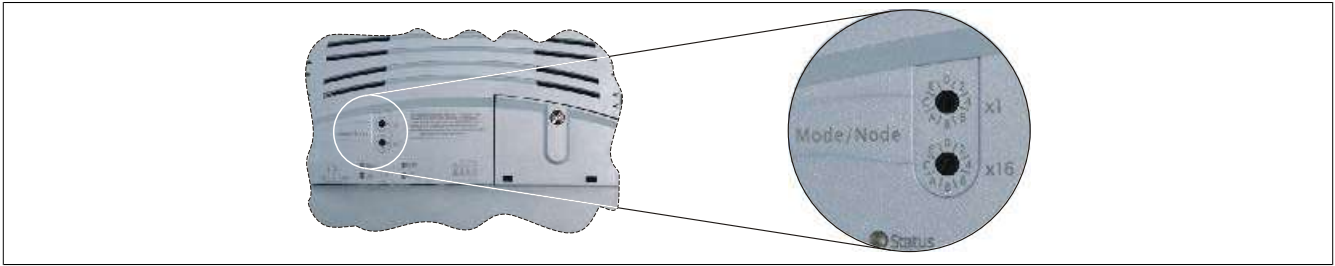

The Power Panel 65 is equipped with 2 hex switches that can be used as operating mode or node number switches. Switch positions 0x01 to 0xFE are used to set the INA node number of the Ethernet interface.

Switch position	Description
0x00	Reserved
0x01 to 0xFE	INA node number of the Ethernet interface
0xFF	Diagnostic mode: Starts up the CPU in diagnostic mode. Does not initialize program sections in User RAM and User FlashPROM. After diagnostic mode, the CPU always starts up with a warm restart.

9.8 Dimensions

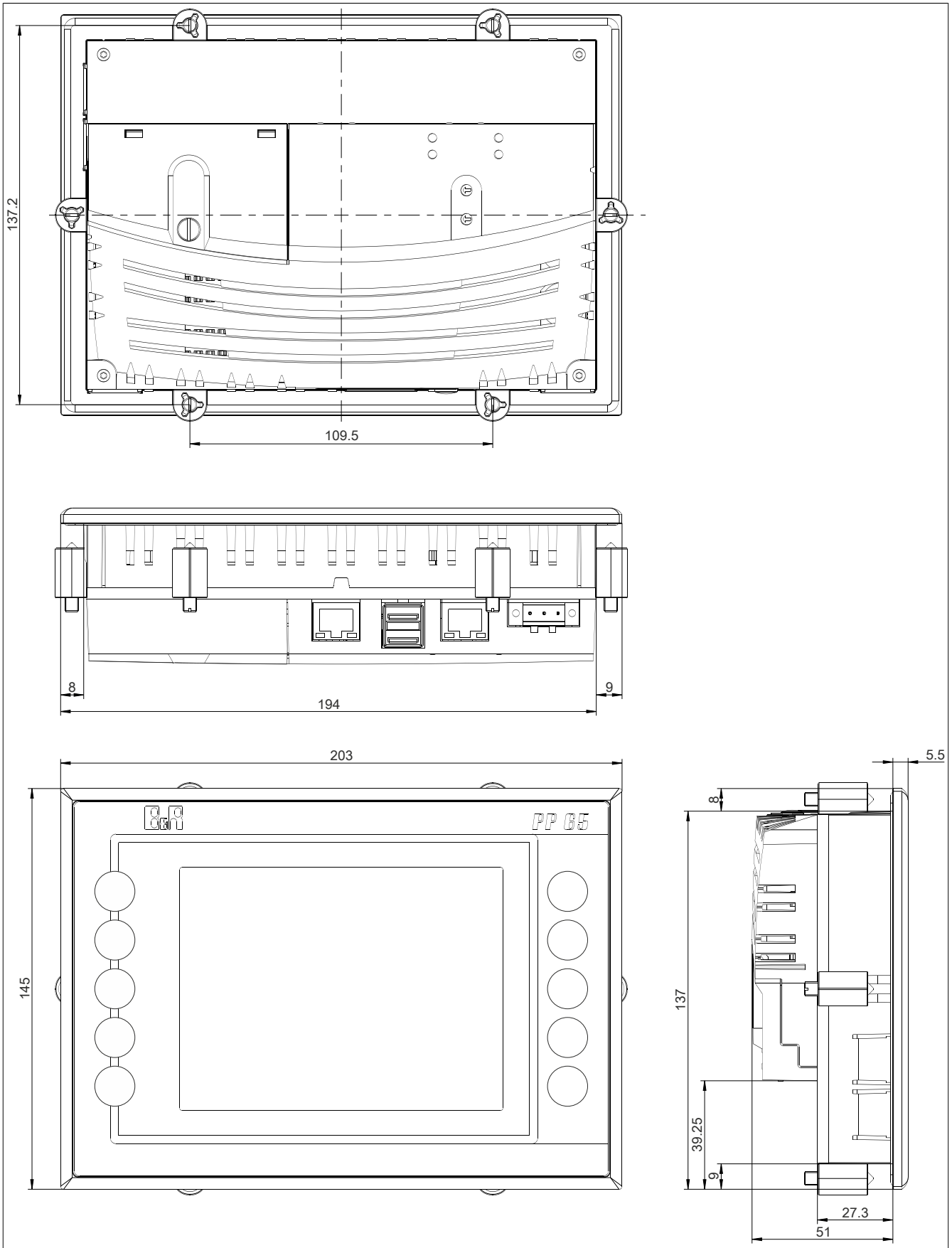

Installation cutout: 188 ±0.5 mm x 130 ±0.5 mm

Chapter 3 • Interface modules

1 General information

Depending on the installed interfaces (Ethernet, X2X, USB), Power Panel 65 devices also provide an extra slot for interface modules. Depending on requirements, the Power Panel 65 can be expanded with CAN bus, a PROFIBUS DP slave or an RS485/RS232 interface, making it perfectly suited for demanding tasks.

2 Overview

Interface module	RS232	RS485/RS422	CAN bus	PROFIBUS DP slave	Page
4PP065.IF10-1	1	-	-	-	70
4PP065.IF23-1	1	1	1	-	72
4PP065.IF24-1	1	1	-	1	76
4PP065.IF33-1	-	-	2	-	80

3 Power Panel 65 support

Interface modules are supported beginning with the following Automation Runtime versions depending on the Power Panel 65 being used.

Power Panel 65	Interface modules			
	4PP065.0351-P74	4PP065.0351-X74	4PP065.0571-P74(F)	4PP065.0571-X74(F)
4PP065.IF10-1	A3.01	C2.96	A3.01	C2.96
4PP065.IF23-1	A3.01	C2.96	A3.01	C2.96
4PP065.IF24-1	A3.07	A3.07	A3.07	A3.07
4PP065.IF33-1	A3.01	C2.96	A3.01	C2.96

4 4PP065.IF10-1

4.1 Order data

Model number	Short description	Figure
	Interface modules	
4PP065.IF10-1	PP65 interface module, 1 RS232 interface	
	Optional accessories	
	Others	
0G0001.00-090	PC - PLC/PW cable, RS232, online cable	

Table 14: 4PP065.IF10-1 - Order data

4.2 Technical data

Model number	4PP065.IF10-1
Short description	
Communication module	1x RS232
General information	
B&R ID code	0xB0B0
Status indicators	Data transfer
Diagnostics	
Data transfer	Yes, using LED status indicators
Electrical isolation	
PLC - IF1	No
Certifications	
CE	Yes
UL	cULus E115267 Industrial control equipment
Interfaces	
Interface IF1	
Type	RS232
Variant	9-pin male DSUB connector
Input filter / Protective circuit	Yes
Max. distance	15 m / 19,200 bit/s
Max. transfer rate	115.2 kbit/s
Network-capable	No
FIFO buffer	16 bytes in transmit and receive direction
Handshake lines	RTS, CTS
Controller	UART type 16C550 compatible
Data formats	
Data bits	5 to 8
Parity	Yes / No / Even / Odd
Stop bits	1 / 2
Operating conditions	
Degree of protection	IP20
Ambient conditions	
Temperature	
Operation	0 to 50°C
Storage	-25 to 70°C
Transport	-25 to 70°C
Relative humidity	
Operation	10 to 90%, non-condensing
Storage	10 to 90%, non-condensing
Transport	10 to 90%, non-condensing
Mechanical properties	
Weight	49 g
Slot	PP65 insert
Torque for mounting screw	Max. 0.6 Nm

Table 15: 4PP065.IF10-1 - Technical data

4.3 LED status indicators

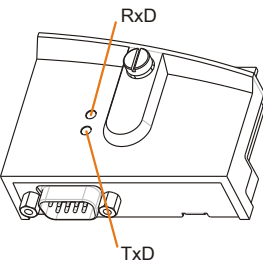
Figure	LED	Color	Status	Description
	RxD	Orange	On	Module receiving data via the RS232 interface
	TxD	Orange	On	Module sending data via the RS232 interface

4.4 RS232 interface

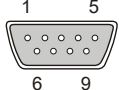
Interface	Pinout		
	Pin	RS232	
 <p>RS232 interface</p> <p>9-pin male DSUB connector</p>	1	NC	
	2	RxD	Receive signal
	3	TxD	Transmit signal
	4	NC	
	5	GND	Ground
	6	NC	
	7	RTS	Request To Send
	8	CTS	Clear To Send
	9	NC	

5 4PP065.IF23-1

5.1 Order data

Model number	Short description	Figure
	Interface modules	
4PP065.IF23-1	PP65 interface module, 1 RS232 interface, 1 RS485/RS422 interface, RS422 electrically isolated, RS485 electrically isolated and network-capable, RS232/RS485/RS422 in one connector, 1 CAN interface electrically isolated and network-capable, order 0TB704 terminal block separately	
	Optional accessories	
	Infrastructure components	
0AC913.93	Bus adapter, CAN bus, 2 CAN bus interfaces, including 03 m attachment cable (TB704)	
	Others	
0G0001.00-090	PC - PLC/PW cable, RS232, online cable	
	Terminal blocks	
0TB704.9	Accessory terminal block, 4-pin, screw clamp terminal block 2.5 mm ²	
0TB704.91	Accessory terminal block, 4-pin, push-in terminal block 2.5 mm ²	

Table 16: 4PP065.IF23-1 - Order data

5.2 Technical data

Model number	4PP065.IF23-1
Short description	
Communication module	1x RS232/RS422/RS485, 1x CAN
General information	
B&R ID code	0xB0BB
Status indicators	
RS232 and CAN bus	Data transfer per interface
RS485/RS422	No display
Diagnostics	
Data transfer	Yes, using LED status indicators
Electrical isolation	
IF1 - IF2	Yes
IF1 - IF3	Yes
IF2 - IF3	Yes
PLC - IF1	No
PLC - IF2	Yes
PLC - IF3	Yes
Certifications	
CE	Yes
UL	cULus E115267 Industrial control equipment
Interfaces	
Interface IF1	
Type	RS232
Variant	9-pin male DSUB connector (shared with IF2)
Input filter / Protective circuit	Yes
Max. distance	15 m / 19,200 bit/s
Max. transfer rate	115.2 kbit/s
Network-capable	No
FIFO buffer	16 bytes in transmit and receive direction
Handshake lines	RTS, CTS
Controller	UART type 16C550 compatible
Data formats	
Data bits	5 to 8
Parity	Yes / No / Even / Odd
Stop bits	1 / 2
Interface IF2	
Type	RS485/RS422
Variant	9-pin male DSUB connector (shared with IF1)
Max. distance	500 m
Max. transfer rate	115.2 kbit/s
Network-capable	Yes
FIFO buffer	16 bytes in transmit and receive direction
Terminating resistor	Integrated in the module
Controller	UART type 16C550 compatible

Table 17: 4PP065.IF23-1 - Technical data

Model number	4PP065.IF23-1
Interface IF3	
Fieldbus	CAN bus
Type	CAN bus
Variant	4-pin male multipoint connector
Controller	SJA 1000
Max. distance	1000 m
Max. transfer rate	1 Mbit/s
Network-capable	Yes
Bus terminating resistor	Integrated in the module, switchable
Max. transfer rate	
Bus length ≤25 m	1 Mbit/s
Bus length ≤60 m	500 kbit/s
Bus length ≤200 m	250 kbit/s
Bus length ≤1000 m	50 kbit/s
Operating conditions	
Degree of protection	IP20
Ambient conditions	
Temperature	
Operation	0 to 50°C
Storage	-25 to 70°C
Transport	-25 to 70°C
Relative humidity	
Operation	10 to 90%, non-condensing
Storage	10 to 90%, non-condensing
Transport	10 to 90%, non-condensing
Mechanical properties	
Weight	57 g
Slot	PP65 insert
Torque for mounting screw	Max. 0.6 Nm

Table 17: 4PP065.IF23-1 - Technical data

5.3 LED status indicators

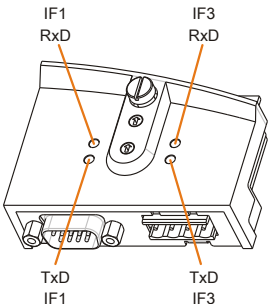
Figure	LED	Color	Status	Description
	RxD	Orange	On	Module receiving data via the RS232 interface
	TxD	Orange	On	Module transmitting data via the X2X Link interface
	IF1 ... RS232 interface			
	IF3 ... CAN bus interface			

5.4 CAN bus node number

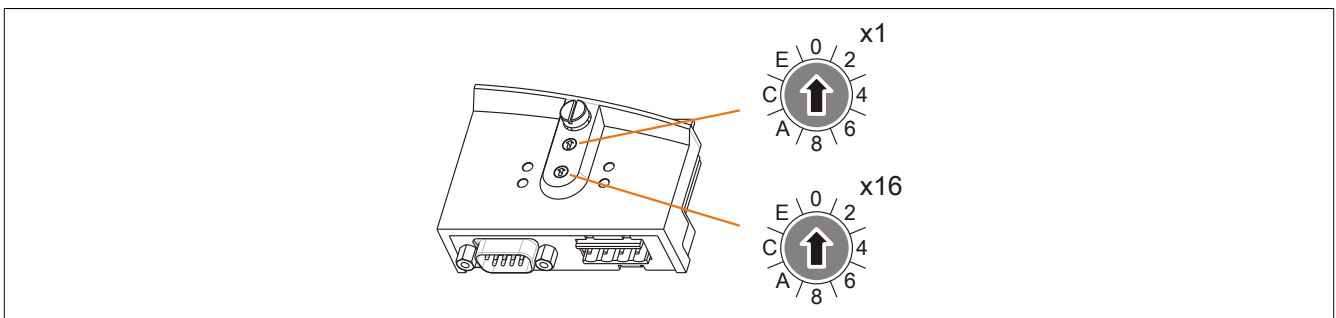

The node number for the CAN bus interface is set with the two hex switches.

5.5 RS232 (IF1) or RS485/RS422 (IF2) interface

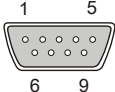
Interface	Pinout			
	Pin	IF1	IF2	
		RS232	RS485	RS422
RS232 or RS485/RS422 interface  9-pin male DSUB connector	1		Tx+/Rx+	Tx+
	2	RxD		
	3	TxD		
	4			Rx+
	5	GND		
	6			Rx-
	7	RTS		
	8	CTS		
	9		Tx-/Rx-	Tx-

Information:

The IF1 and IF2 interfaces can be used simultaneously when wired appropriately.

5.6 CAN bus interface (IF3)

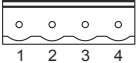
Interface	Pinout		
	Pin	CAN bus	
CAN bus interface  4-pin male multipoint connector	1	CAN_H	CAN high
	2	CAN_⊥	CAN ground
	3	CAN_L	CAN low
	4	SHLD	Shield

5.7 Terminating resistors

Two switches are located on the back of the interface module that can be used to switch on a terminating resistor for IF2 (RS485/RS422) and IF3 (CAN bus).

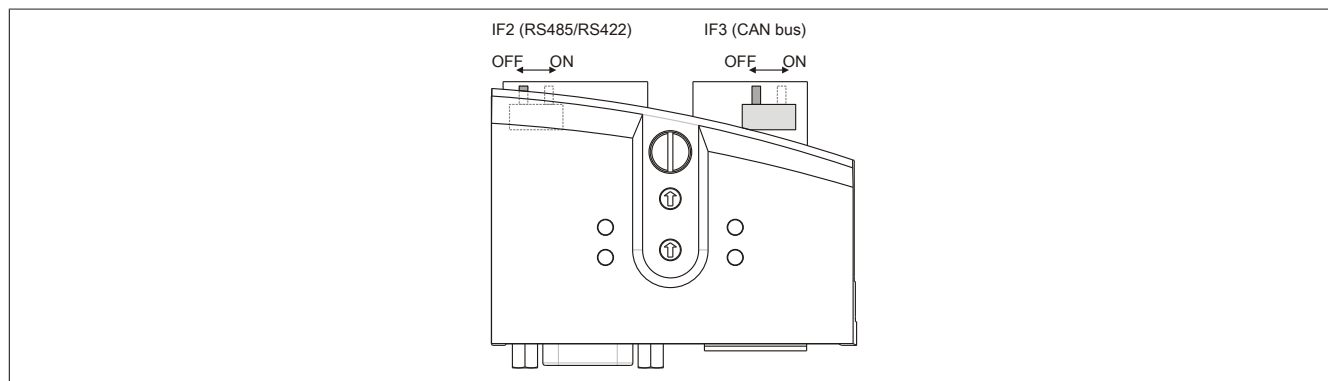

Interface	Switch position	Description
IF2 (RS485/RS422)	ON	Terminating resistor enabled (150 Ω)
	OFF	Terminating resistor disabled
IF3 (CAN bus)	ON	Terminating resistor enabled (120 Ω)
	OFF	Terminating resistor disabled

5.8 I/O mapping in Automation Studio

Data points for interfaces IF1 and IF2 are available in the I/O mapping in Automation Studio.

I/O mapping for IF2

Channel name	Data type	Description
TerminatingResistor ¹⁾	BOOL	State of the switch for the IF2 terminating resistor: 0 ... OFF: Terminating resistor disabled 1 ... ON: Terminating resistor enabled

1) TerminatingResistor only available in Automation Runtime A4.32 and later.

I/O mapping for IF3

Channel name	Data type	Description
NodeSwitch	USINT	Hexadecimal value of the node number switch.
TerminatingResistor ¹⁾	BOOL	State of the switch for the IF3 terminating resistor: 0 ... OFF: Terminating resistor disabled 1 ... ON: Terminating resistor enabled

1) TerminatingResistor only available in Automation Runtime A4.32 and later.

6 4PP065.IF24-1

6.1 Order data

Model number	Short description	Figure
	Interface modules	
4PP065.IF24-1	PP65 interface module, 1 PROFIBUS DP slave interface electrically isolated and network-capable, 1 RS232 interface, 1 RS422/RS485 interface, RS422/RS485: electrically isolated and network-capable, RS232/RS422/RS485 in one connector	
	Optional accessories	
	Infrastructure components	
0G1000.00-090	Bus connector, RS485, for PROFIBUS networks	
	Others	
0G0001.00-090	PC - PLC/PW cable, RS232, online cable	

Table 18: 4PP065.IF24-1 - Order data

6.2 Technical data

Model number	4PP065.IF24-1
Short description	
Communication module	1x RS232/RS422, RS485 1x PROFIBUS DP slave
General information	
B&R ID code	0xB0BC
Status indicators	Data transfer per interface
Diagnostics	
Data transfer	Yes, using LED status indicators
Electrical isolation	
PLC - IF1	No
PLC - IF2	Yes
PLC - IF3	Yes
Certifications	
CE	Yes
UL	cULus E115267 Industrial control equipment
Interfaces	
Interface IF1	
Type	RS232
Variant	9-pin male DSUB connector (shared with IF2)
Input filter / Protective circuit	Yes
Max. distance	15 m / 19,200 bit/s
Max. transfer rate	115.2 kbit/s
Network-capable	No
FIFO buffer	16 bytes in transmit and receive direction
Handshake lines	RTS, CTS
Controller	UART type 16C550 compatible
Data formats	
Data bits	5 to 8
Parity	Yes / No / Even / Odd
Stop bits	1 / 2
Interface IF2	
Type	RS485/RS422
Variant	9-pin male DSUB connector (shared with IF1)
Max. distance	500 m
Max. transfer rate	115.2 kbit/s
Network-capable	Yes
FIFO buffer	16 bytes in transmit and receive direction
Terminating resistor	Integrated in the module, switchable
Controller	UART type 16C550 compatible

Table 19: 4PP065.IF24-1 - Technical data

Model number	4PP065.IF24-1
Interface IF3	
Fieldbus	PROFIBUS DP slave
Type	RS485
Variant	9-pin female DSUB connector
Controller	ASIC SPC3
RAM	1.5 kB
Max. distance	1000 m
Max. transfer rate	12 Mbit/s
Network-capable	Yes
Bus terminating resistor	Integrated in the module
Max. transfer rate	
Bus length ≤100 m	12 Mbit/s
Bus length ≤200 m	1.5 Mbit/s
Bus length ≤400 m	500 kbit/s
Bus length ≤1000 m	187.5 kbit/s
Operating conditions	
Degree of protection	IP20
Ambient conditions	
Temperature	
Operation	0 to 50°C
Storage	-25 to 70°C
Transport	-25 to 70°C
Relative humidity	
Operation	10 to 90%, non-condensing
Storage	10 to 90%, non-condensing
Transport	10 to 90%, non-condensing
Mechanical properties	
Weight	65 g
Slot	PP65 insert
Torque for mounting screw	Max. 0.6 Nm

Table 19: 4PP065.IF24-1 - Technical data

6.3 LED status indicators

Figure	LED	Color	Status	Description
	RxD	Orange	On	Module receiving data via the RS232 interface
	TxD	Orange	On	Module transmitting data via the X2X Link interface
IF1 ... RS232 interface IF3 ... PROFIBUS DP slave interface				

6.4 PROFIBUS DP slave node number

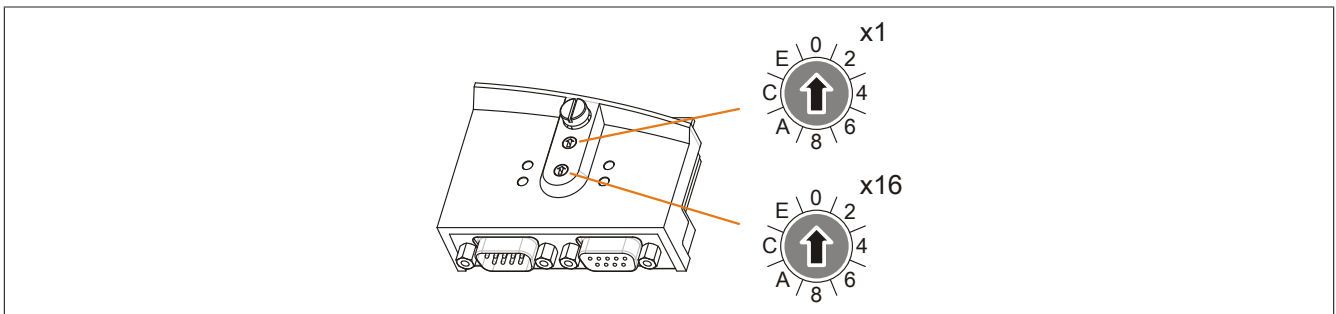

The node number for the PROFIBUS DP slave interface is set with the 2 hex switches.

The AsL2DP library is used for the 4PP065.IF24-1.

6.5 RS232 (IF1) or RS485/RS422 (IF2) interface

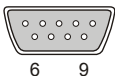
Interface	Pinout			
	Pin	IF1	IF2	
		RS232	RS485	RS422
RS232 or RS485/RS422 interface  9-pin male DSUB connector	1		Tx+/Rx+	Tx+
	2	RxD		
	3	TxD		
	4			Rx+
	5	GND		
	6			Rx-
	7	RTS		
	8	CTS		
	9		Tx-/Rx-	Tx-

Information:

The IF1 and IF2 interfaces can be used simultaneously when wired appropriately.

6.6 PROFIBUS DP slave interface (IF3)

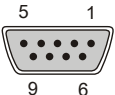
Interface	Pinout		
	Pin	PROFIBUS	
PROFIBUS DP slave interface  9-pin female DSUB connector	1	NC	
	2	NC	
	3	DATA	Data
	4	CTRL	Transmit enable
	5	GND	PROFIBUS GND (electrically isolated)
	6	5 V / 50 mA	Power supply (electrically isolated)
	7	NC	
	8	DATA\	Data inverted
	9	CTRL\	Transmit enable inverted

6.7 Terminating resistors

Two switches are located on the back of the interface module that can be used to switch on a terminating resistor for IF2 (RS485) and IF3 (PROFIBUS DP).

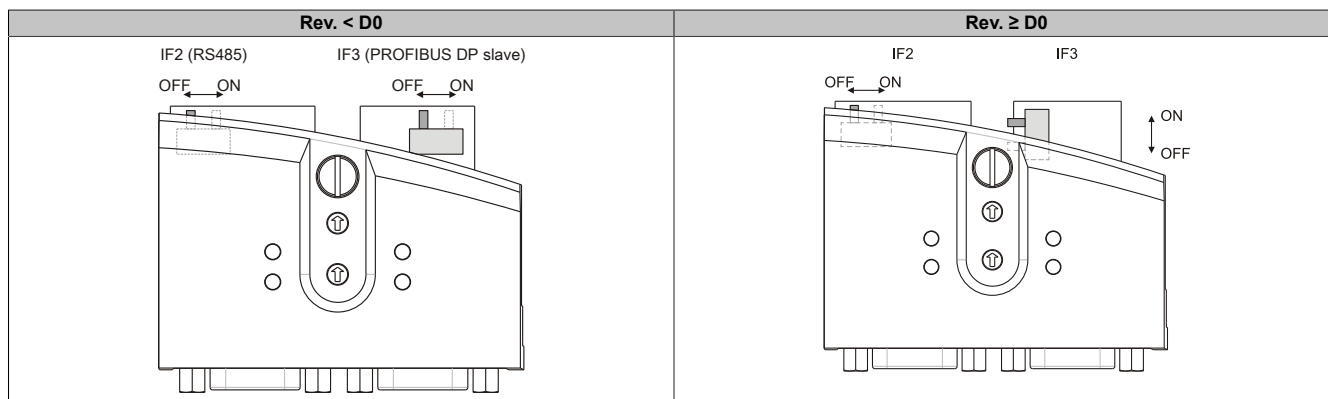

Interface	Switch position	Description
IF2	ON	Terminating resistor switched on (170 Ω between pin 1 and pin 9)
	OFF	Terminating resistor disabled
IF3	ON	Terminating resistor switched on (170 Ω between pin 1 and pin 9)
	OFF	Terminating resistor disabled

6.8 I/O mapping in Automation Studio

One data point for interface IF2 is available in the I/O mapping in Automation Studio.

I/O mapping for IF2

Channel name	Data type	Description
TerminatingResistor ¹⁾	BOOL	State of the switch for the IF2 terminating resistor: 0 ... OFF: Terminating resistor disabled 1 ... ON: Terminating resistor enabled

1) TerminatingResistor only available in Automation Runtime A4.32 and later.

I/O mapping for IF3

Interface IF3 is not shown in the I/O mapping in Automation Studio.

This interface is operated using library AsL2DP.

7 4PP065.IF33-1

7.1 Order data

Model number	Short description	Figure
	Interface modules	
4PP065.IF33-1	PP65 interface module, 2 CAN interfaces electrically isolated and network-capable, order 0TB704 terminal block separately	
	Required accessories	
	Terminal blocks	
0TB704.9	Accessory terminal block, 4-pin, screw clamp terminal block 2.5 mm ²	
0TB704.91	Accessory terminal block, 4-pin, push-in terminal block 2.5 mm ²	
	Optional accessories	
	Infrastructure components	
0AC913.93	Bus adapter, CAN bus, 2 CAN bus interfaces, including 03 m attachment cable (TB704)	

Table 20: 4PP065.IF33-1 - Order data

7.2 Technical data

Model number	4PP065.IF33-1
Short description	
Communication module	2x CAN bus
General information	
B&R ID code	0xB0BD
Status indicators	Data transfer for IF1 and IF2
Diagnosics	
Data transfer	Yes, using LED status indicators
Electrical isolation	
IF1 - IF2	Yes
PLC - IF1	Yes
PLC - IF2	Yes
Certifications	
CE	Yes
UL	cULus E115267 Industrial control equipment
Interfaces	
Interface IF1	
Type	CAN bus
Variant	1x 4-pin male multipoint connector
Max. distance	1000 m
Max. transfer rate	1000 kbit/s
Network-capable	Yes
Terminating resistor	Integrated in the module, switchable
Controller	SJA 1000
Max. transfer rate	
Bus length ≤25 m	1 Mbit/s
Bus length ≤60 m	500 kbit/s
Bus length ≤200 m	250 kbit/s
Bus length ≤1000 m	50 kbit/s
Interface IF2	
Type	CAN bus
Variant	1x 4-pin male multipoint connector
Max. distance	1000 m
Max. transfer rate	1000 kbit/s
Network-capable	Yes
Terminating resistor	Integrated in the module, switchable
Controller	SJA 1000
Max. transfer rate	
Bus length ≤25 m	1 Mbit/s
Bus length ≤60 m	500 kbit/s
Bus length ≤200 m	250 kbit/s
Bus length ≤1000 m	50 kbit/s
Operating conditions	
Degree of protection	IP20
Ambient conditions	
Temperature	
Operation	0 to 50°C
Storage	-25 to 70°C
Transport	-25 to 70°C

Table 21: 4PP065.IF33-1 - Technical data

Model number	4PP065.IF33-1
Relative humidity	
Operation	10 to 90%, non-condensing
Storage	10 to 90%, non-condensing
Transport	10 to 90%, non-condensing
Mechanical properties	
Weight	46 g
Slot	PP65 insert
Torque for mounting screw	Max. 0.6 Nm

Table 21: 4PP065.IF33-1 - Technical data

7.3 LED status indicators

Figure	LED	Color	Status	Description
	RxD	Orange	On	Module receiving data via the RS232 interface
	TxD	Orange	On	Module transmitting data via the X2X Link interface
	IF1 ... CAN bus interface 1			
	IF2 ... CAN bus interface 2			

7.4 CAN bus node number

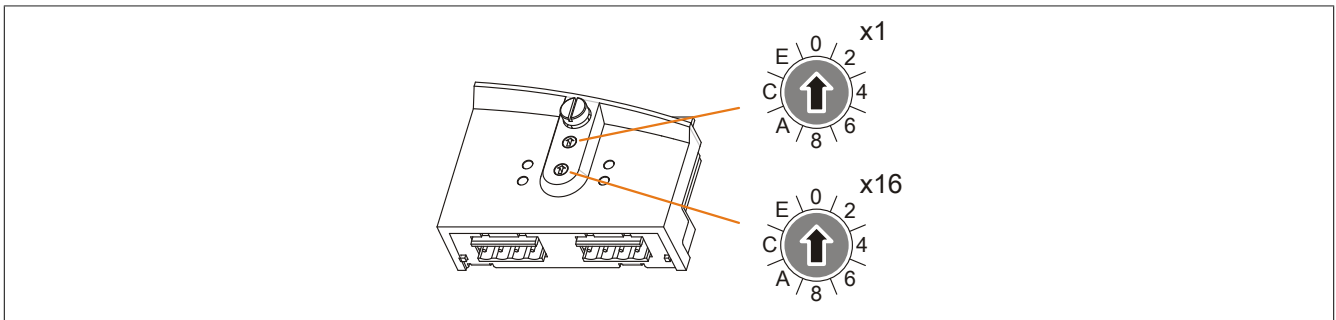

The node number for the CAN bus interfaces is set with the two hex switches. The configured node number applies to both interfaces.

7.5 CAN bus interface (IF1 and IF2)

Interface	Pinout		
CAN bus interface 4-pin male multipoint connector	Pin	CAN bus	
	1	CAN_H	CAN high
	2	CAN _⊥	CAN ground
	3	CAN_L	CAN low
	4	SHLD	Shield

7.6 Terminating resistors

Two switches are located on the back of the interface module that can be used to switch on a terminating resistor for the CAN bus interfaces IF1 and IF2.

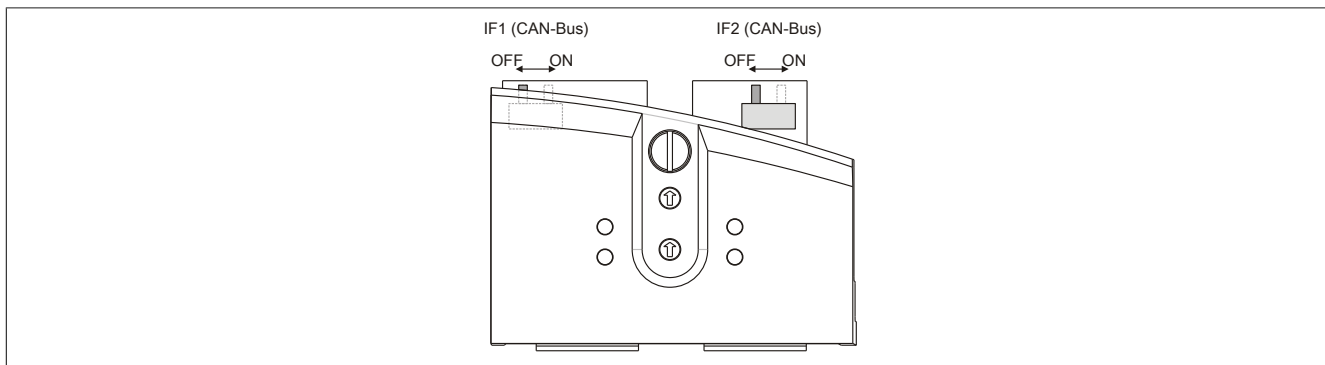

Interface	Switch position	Description
IF1 (CAN bus)	ON	Terminating resistor enabled (120 Ω)
	OFF	Terminating resistor disabled
IF2 (CAN bus)	ON	Terminating resistor enabled (120 Ω)
	OFF	Terminating resistor disabled

7.7 I/O mapping in Automation Studio

Data points for interfaces IF1 and IF2 are available in the I/O mapping in Automation Studio.

I/O mapping for IF1

Channel name	Data type	Description
NodeSwitch	USINT	Hexadecimal value of the node number switch (identical with NodeSwitch of IF2).
TerminatingResistor ¹⁾	BOOL	State of the switch for the IF1 terminating resistor: 0 ... OFF: Terminating resistor disabled 1 ... ON: Terminating resistor enabled

1) TerminatingResistor only available in Automation Runtime A4.32 and later.

I/O mapping for IF2

Channel name	Data type	Description
NodeSwitch	USINT	Hexadecimal value of the node number switch (identical with NodeSwitch of IF1).
TerminatingResistor ¹⁾	BOOL	State of the switch for the IF2 terminating resistor: 0 ... OFF: Terminating resistor disabled 1 ... ON: Terminating resistor enabled

1) TerminatingResistor only available in Automation Runtime A4.32 and later.

Chapter 4 • Commissioning

1 Installation cutout requirements

When installing the Power Panel, it is important to ensure that the wall thickness meets the following conditions:

Properties of the installation cutout	Value
Min. wall thickness	2 mm
Max. wall thickness	6 mm

2 Installation instructions

The Power Panel must be installed using the retaining clips included in delivery (tightening torque: 0.6 Nm). Each Power Panel comes with six retaining clips (two each for top/bottom and one each for left/right).

In order to ensure sufficient air circulation, the specified clearance values must be observed above, below, to the side and behind the Power Panel device. The minimum specified spacing is indicated in the following diagrams. This applies to all Power Panel variants.

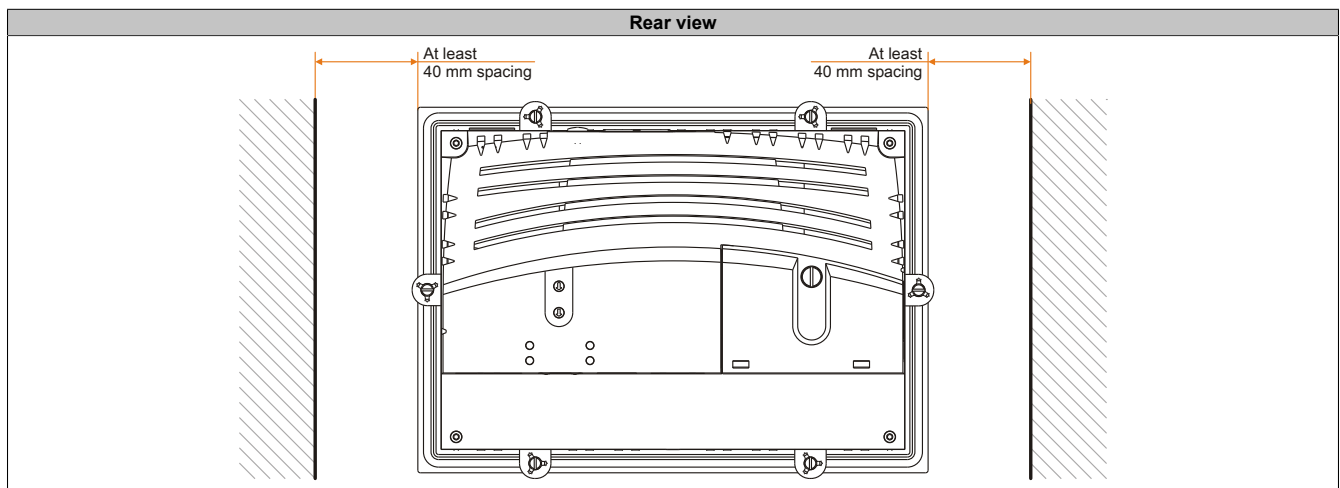

Table 22: Spacing for air circulation - Rear view

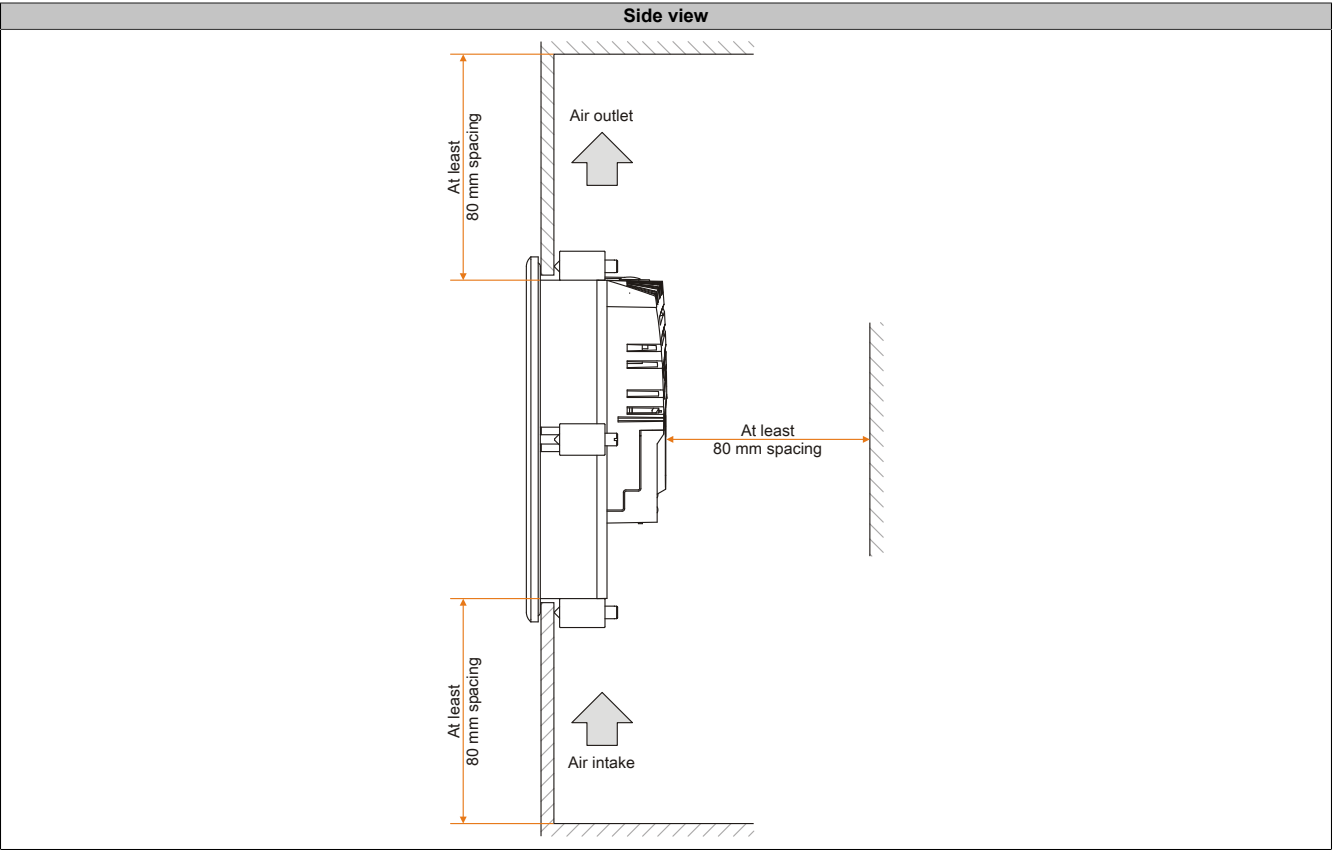

Table 23: Spacing for air circulation - Side view

3 Mounting orientations

The following diagram shows the approved mounting orientations for Power Panel devices. The mounting orientations apply to all Power Panel variants.

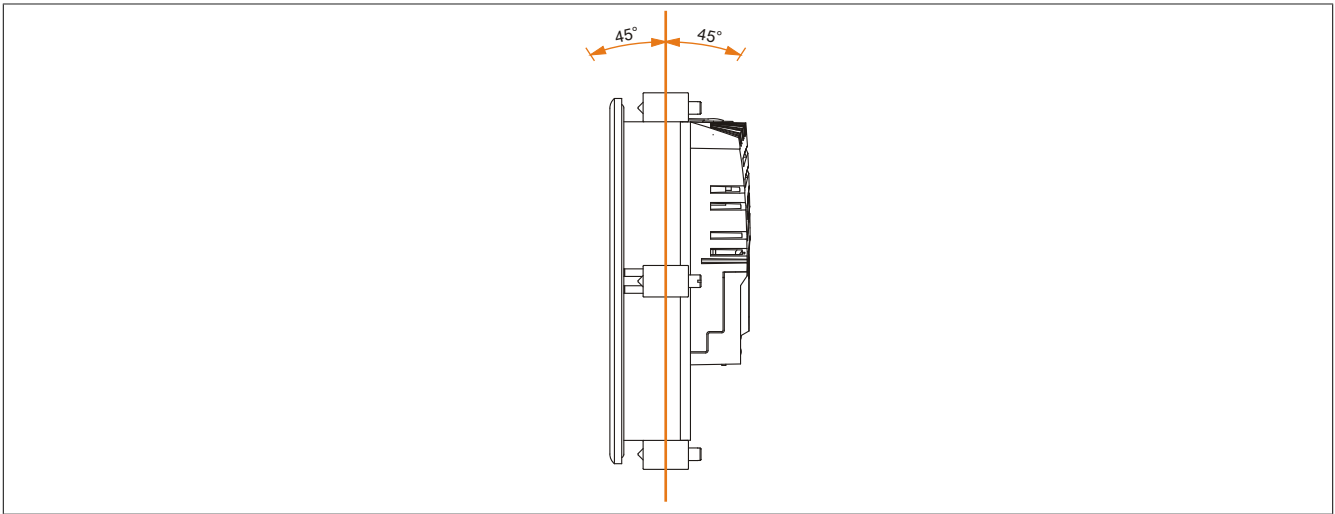
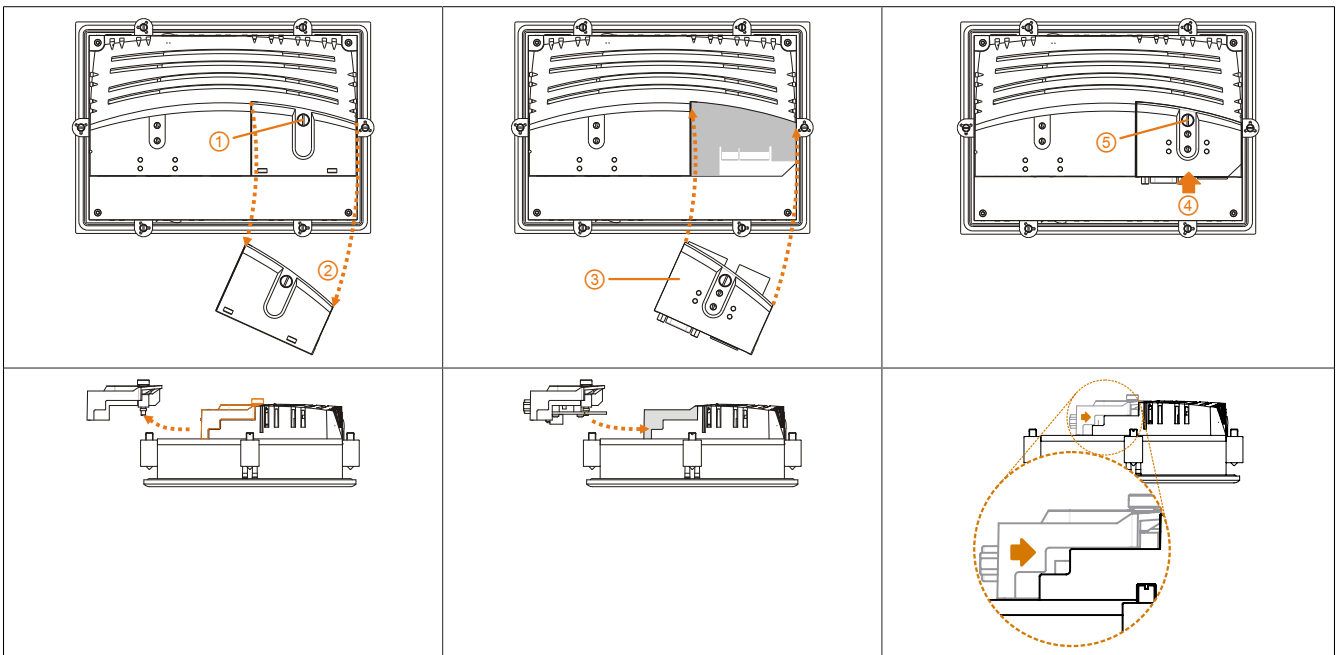

Figure 1: Power Panel - Mounting orientations

Caution!

For the maximum permissible ambient temperature, see the technical data for the respective Power Panel device.

4 Installing interface modules



- 1) Remove the screws from the cover.
- 2) Remove the cover.
- 3) Insert the interface module into the PP65.
- 4) Apply light pressure until the interface module is inserted all the way.
- 5) Secure the interface module with the screws (max. 0.6 Nm).

5 Touch screen calibration

B&R touch screen devices are equipped with a touch controller that supports hardware calibration. This means that devices are pre-calibrated when delivered. This feature is a particularly helpful advantage for replacement parts because recalibration is usually no longer necessary when replacing the device (identical model/type). Nevertheless, calibrating the device is still recommended in order to achieve the best results and to better adapt the touch screen to the user's preferences.

6 Screen rotation

It is possible to rotate the contents of the screen by 90° using the graphic driver's screen rotation function. This function is supported by Automation Runtime.

In Automation Studio 2.7.x or 3.0.x, the screen orientation can be defined when a project is created or later when editing the project.

Chapter 5 • Standards and certifications

1 Applicable European directives

- EMC directive 89/336/EEC
- Low-voltage directive 73/23/EEC
- Machine directive 98/37/EC

2 Overview of standards

Power Panel 65 devices meet the following standards:

Standard	Description
EN 55011 Class A, B	Electromagnetic compatibility (EMC), radio disturbance product standard, industrial, scientific, and medical high-frequency devices (ISM devices), limit values and measurement procedure; group 1 (devices that do not generate HF during material processing) and group 2 (devices that generate HF during material processing)
EN 55022 Class A, B	Electromagnetic compatibility (EMC), radio disturbance characteristics, information technology equipment (ITE devices), limits and methods of measurement
EN 55024 Class A or B	Electromagnetic compatibility (EMC), immunity, information technology equipment (ITE devices), limits and methods of measurement
EN 60060-2	High-voltage test techniques - part 2: Measuring systems
EN 60068-2-1	Environmental testing - part 2: Tests: Test A: Cold
EN 60068-2-2	Environmental testing - part 2: Tests: Test B: Dry heat
EN 60068-2-3	Environmental testing - part 2: Tests: Test cab: Damp heat, steady state
EN 60068-2-6	Environmental testing - part 2: Tests: Test Fc: Vibration (sinusoidal)
EN 60068-2-14	Environmental testing - part 2: Tests: Test N: Change of temperature
EN 60068-2-27	Environmental testing - part 2: Tests: Test cab: Shock
EN 60068-2-30	Environmental testing - part 2: Tests: Test cab: Damp heat, cyclic
EN 60068-2-31	Environmental testing - part 2: Tests: Test Fc: Drop and topple, primarily for equipment-type specimens
EN 60068-2-32	Environmental testing - part 2: Tests: Test Fc: Free fall
EN 60204-1	Safety of machinery - Electrical equipment of machines - Part 1: General requirements
EN 60529	Degrees of protection provided by enclosures (IP code)
EN 61000-4-2	Electromagnetic compatibility (EMC) - Part 4-2: Testing and measuring techniques; electrostatic discharge immunity test
EN 61000-4-3	Electromagnetic compatibility (EMC) - Part 4-3: Testing and measuring techniques; radiated radio-frequency electromagnetic field immunity test
EN 61000-4-4	Electromagnetic compatibility (EMC) - Part 4-4: Testing and measuring techniques; electrical fast transient/burst immunity test
EN 61000-4-5	Electromagnetic compatibility (EMC) - Part 4-5: Testing and measuring techniques; surge immunity test
EN 61000-4-6	Electromagnetic compatibility (EMC) - Part 4-6: Testing and measuring techniques; immunity to conducted disturbances, induced by radio-frequency fields
EN 61000-4-8	Electromagnetic compatibility (EMC) - Part 4-8: Testing and measuring techniques; power frequency magnetic field immunity test
EN 61000-4-11	Electromagnetic compatibility (EMC) - Part 4-11: Testing and measuring techniques; voltage dips, short interruptions and voltage variations immunity tests
EN 61000-4-12	Electromagnetic compatibility (EMC) - Part 4-12: Testing and measuring techniques; oscillatory waves immunity test
EN 61000-6-2	Electromagnetic compatibility (EMC) - Part 2 - Generic standards - Immunity for industrial environments
EN 61000-6-4	Electromagnetic compatibility (EMC) - Part 2 - Generic standards - Emission standard for industrial environments
EN 61131-2 IEC 61131-2	Programmable logic controllers - Part 2: Equipment requirements and tests
NEMA 250 type 4X	Rating according to UL - Sprayed water
UL 508	Industrial control equipment (UL = Underwriters Laboratories)

3 Emission requirements

Emissions	Test carried out in accordance with	Limits in accordance with
Network-related emissions	EN 55011 / EN 55022	EN 61000-6-4: Generic standard (industrial areas)
		EN 55011: Industrial, scientific, and medical equipment - Radio-frequency disturbance characteristics - Class A (industrial areas)
		EN 55022: Information technology equipment (ITE devices) - Class A (industrial areas)
		EN 61131-2: Programmable logic controllers
Emitted interferences Electromagnetic emissions	EN 55011 / EN 55022	EN 61000-6-4: Generic standard (industrial areas)
		EN 55011: Industrial, scientific, and medical equipment - Radio-frequency disturbance characteristics - Class A (industrial areas)
		EN 55022: Information technology equipment (ITE devices) - Class A (industrial areas)
		EN 61131-2: Programmable logic controllers

3.1 Network-related emissions

Test carried out in accordance with EN 55011 / EN 55022	Limits in accordance with EN 61000-6-4	Limits in accordance with EN 55011 Class A	Limits in accordance with EN 55022 Class A	Limits in accordance with EN 61131-2	Limits in accordance with 47 CFR Part 15 Subpart B class A
Power mains connections ¹⁾ 150 to 500 kHz	79 dB (μV) Quasi-peak value 66 dB (μV) Mean value	79 dB (μV) Quasi-peak value 66 dB (μV) Mean value	79 dB (μV) Quasi-peak value 66 dB (μV) Mean value	79 dB (μV) Quasi-peak value 66 dB (μV) Mean value	79 dB (μV) Quasi-peak value 66 dB (μV) Mean value
Power mains connections 500 kHz to 30 MHz	73 dB (μV) Quasi-peak value 60 dB (μV) Mean value	73 dB (μV) Quasi-peak value 60 dB (μV) Mean value	73 dB (μV) Quasi-peak value 60 dB (μV) Mean value	73 dB (μV) Quasi-peak value 60 dB (μV) Mean value	73 dB (μV) Quasi-peak value 60 dB (μV) Mean value
Other connections 150 to 500 kHz	-	-	97 to 87 dB (μV) and 53 to 43 dB (μA) Quasi-peak value 84 to 74 dB (μV) and 40 to 30 dB (μA) Mean value	-	-
Other connections 500 kHz to 30 MHz	-	-	87 dB (μV) and 43 dB (μA) Quasi-peak value 74 dB (μV) and 30 dB (μA) Mean value	-	-

1) AC network connections only with EN 61131-2

3.2 Emissions, electromagnetic emissions

Test carried out in accordance with EN 55011 / EN 55022	Limits in accordance with EN 61000-6-4	Limits in accordance with EN 55011 Class A	Limits in accordance with EN 55022 Class A	Limits in accordance with EN 61131-2
30 to 230 MHz measured at a distance of 10 m	<40 dB (μV/m) Quasi-peak value	<40 dB (μV/m) Quasi-peak value	<40 dB (μV/m) Quasi-peak value	<40 dB (μV/m) Quasi-peak value
230 MHz to 1 GHz measured at a distance of 10 m	<47 dB (μV/m) Quasi-peak value	<47 dB (μV/m) Quasi-peak value	<47 dB (μV/m) Quasi-peak value	<47 dB (μV/m) Quasi-peak value
Test carried out	Limits in accordance with 47 CFR Part 15 Subpart B Class A			
30 to 88 MHz measured at a distance of 10 m	<90 dB (μV/m) Quasi-peak value			
88 to 216 MHz measured at a distance of 10 m	<150 dB (μV/m) Quasi-peak value			
216 to 960 MHz measured at a distance of 10 m	<210 dB (μV/m) Quasi-peak value			
>960 MHz measured at a distance of 10 m	<300 dB (μV/m) Quasi-peak value			

4 Requirements for immunity to disturbances

Immunity	Test carried out in accordance with	Limits in accordance with
Electrostatic discharge (ESD)	EN 61000-4-2	EN 61000-6-2: Generic standard (industrial areas)
		EN 61131-2: Programmable logic controllers
		EN 55024: Information technology equipment
Immunity to high-frequency electromagnetic fields (HF field)	EN 61000-4-3	EN 61000-6-2: Generic standard (industrial areas)
		EN 61131-2: Programmable logic controllers
		EN 55024: Information technology equipment
Immunity to high-speed transient electrical disturbances (burst)	EN 61000-4-4	EN 61000-6-2: Generic standard (industrial areas)
		EN 61131-2: Programmable logic controllers
		EN 55024: Information technology equipment
Immunity to surge voltages	EN 61000-4-5	EN 61000-6-2: Generic standard (industrial areas)
		EN 61131-2: Programmable logic controllers
		EN 55024: Information technology equipment
Immunity to conducted disturbances	EN 61000-4-6	EN 61000-6-2: Generic standard (industrial areas)
		EN 61131-2: Programmable logic controllers
		EN 55024: Information technology equipment
Immunity against magnetic fields with electrical frequencies	EN 61000-4-8	EN 61000-6-2: Generic standard (industrial areas)
		EN 61131-2: Programmable logic controllers
		EN 55024: Information technology equipment
Immunity to voltage dips, short-term interruptions and voltage fluctuations	EN 61000-4-11	EN 61000-6-2: Generic standard (industrial areas)
		EN 61131-2: Programmable logic controllers
		EN 55024: Information technology equipment
Immunity to damped vibration	EN 61000-4-12	EN 61000-6-2: Generic standard (industrial areas)
		EN 61131-2: Programmable logic controllers
		EN 55024: Information technology equipment

Evaluation criteria in accordance with EN 61000-6-2

Criteria A:

The operating equipment must continue to work as intended **during** the test. There should be no interference in the operating behavior and no system failures below a minimum operating quality as defined by the manufacturer.

Criteria B:

The operating equipment must continue to work as directed **after** the test. There should be no interference in the operating behavior and no system failures below a minimum operating quality as defined by the manufacturer.

Criteria C:

A temporary function failure is permitted if the function restores itself, or the function can be restored by activating configuration and control elements.

Criteria D:

Degradation or failure of functionality which can no longer be restored (operating equipment destroyed).

4.1 Electrostatic discharge (ESD)

Test carried out in accordance with EN 61000-4-2	Limits in accordance with EN 61000-6-2	Limits in accordance with EN 61131-2	Limits in accordance with EN 55024
Contact discharge to powder-coated and bare metal housing parts	±4kV, 10 discharges, Criteria B	±4kV, 10 discharges, Criteria B	±4kV, 10 discharges, Criteria B
Discharge through the air to plastic housing parts	±8kV, 10 discharges, Criteria B	±8kV, 10 discharges, Criteria B	±8kV, 10 discharges, Criteria B

4.2 High-frequency electromagnetic fields (HF field)

Test carried out in accordance with EN 61000-4-3	Limits in accordance with EN 61000-6-2	Limits in accordance with EN 61131-2	Limits in accordance with EN 55024
Housing, completely wired	80 MHz to 1 GHz, 10 V/m, 80% amplitude modulation with 1 kHz, duration 3 seconds, criteria A	80 MHz to 1 GHz, 1.4 to 2 GHz, 10 V/m, 80% amplitude modulation with 1 kHz, duration 3 seconds, criteria A 800 to 960 MHz (GSM), 10 V/m, pulse modulation with 50% duty cycle, criteria A	80 MHz to 1 GHz, 1.4 to 2 GHz, 3 V/m, 80% amplitude modulation with 1 kHz, duration 3 seconds, criteria A

4.3 High-speed transient electrical disturbances (Burst)

Test carried out in accordance with EN 61000-4-4	Limits in accordance with EN 61000-6-2	Limits in accordance with EN 61131-2	Limits in accordance with EN 55024
AC mains inputs/outputs	±2 kV, criteria B	-	±1 kV, criteria B
AC power inputs	-	±2 kV, criteria B	-
AC power outputs	-	±1 kV, criteria B	-
DC mains inputs/outputs >10 m ¹⁾	±2 kV, criteria B	-	±0.5 kV, criteria B
DC power inputs >10 m	-	±2 kV, criteria B	-
DC power outputs >10 m	-	±1 kV, criteria B	-
Functional ground connections, signal lines and I/Os >3 m	±1 kV, criteria B	±1 kV, criteria B	±0.5 kV, criteria B
Unshielded AC inputs/outputs >3m	-	±2 kV, criteria B	-
Analog I/O	±1 kV, criteria B	±1 kV, criteria B	-

1) For EN 55024 without length limitation.

4.4 Surge voltages (Surge)

Test carried out in accordance with EN 61000-4-5	Limits in accordance with EN 61000-6-2	Limits in accordance with EN 61131-2	Limits in accordance with EN 55024
AC mains inputs/outputs, L to L	±1 kV, criteria B	±1 kV, criteria B	±1 kV, criteria B
AC mains inputs/outputs, L to PE	±2 kV, criteria B	±2 kV, criteria B	±2 kV, criteria B
DC mains inputs/outputs, L+ to L-, >10 m	±0.5 kV, criteria B	-	-
DC mains inputs/outputs, L to PE, >10 m	±0.5 kV, criteria B	-	±0.5 kV, criteria B
DC power inputs, L+ to L-	-	±0.5 kV, criteria B	-
DC power inputs, L to PE	-	±1 kV, criteria B	-
DC power outputs, L+ to L-	-	±0.5 kV, criteria B	-
DC power outputs, L to PE	-	±0.5 kV, criteria B	-
Signal connections >30 m	±1 kV, criteria B	±1 kV, criteria B	±1 kV, criteria B
All shielded cables	-	±1 kV, criteria B	-

4.5 Conducted disturbances

Test carried out in accordance with EN 61000-4-6	Limits in accordance with EN 61000-6-2	Limits in accordance with EN 61131-2	Limits in accordance with EN 55024
AC mains inputs/outputs	150 kHz to 80 MHz, 10 V, 80% amplitude modulation with 1 kHz, duration 3 seconds, criteria A	150 kHz to 80 MHz, 3 V, 80% amplitude modulation with 1 kHz, duration 3 seconds, criteria A	150 kHz to 80 MHz, 3 V, 80% amplitude modulation with 1 kHz, criteria A
DC mains inputs/outputs	150 kHz to 80 MHz, 10 V, 80% amplitude modulation with 1 kHz, duration 3 seconds, criteria A	150 kHz to 80 MHz, 3 V, 80% amplitude modulation with 1 kHz, duration 3 seconds, criteria A	150 kHz to 80 MHz, 3 V, 80% amplitude modulation with 1 kHz, criteria A
Functional ground connections	150 kHz to 80 MHz, 10 V, 80% amplitude modulation with 1 kHz, duration 3 seconds, criteria A	150 kHz to 80 MHz, 3 V, 80% amplitude modulation with 1 kHz, duration 3 seconds, criteria A	-
Signal connections >3 m	150 kHz to 80 MHz, 10 V, 80% amplitude modulation with 1 kHz, duration 3 seconds, criteria A	150 kHz to 80 MHz, 3 V, 80% amplitude modulation with 1 kHz, duration 3 seconds, criteria A	150 kHz to 80 MHz, 3 V, 80% amplitude modulation with 1 kHz, criteria A

4.6 Magnetic fields with electrical frequencies

Test carried out in accordance with EN 61000-4-8	Limits in accordance with EN 61000-6-2	Limits in accordance with EN 61131-2	Limits in accordance with EN 55024
Test direction x, test in the field of an induction coil 1m x 1m	30 A/m, criteria A	30 A/m, criteria A	50 Hz, 1 A/m, criteria A
Test direction y, test in the field of an induction coil 1m x 1m	30 A/m, criteria A	30 A/m, criteria A	50 Hz, 1 A/m, criteria A
Test direction z, test in the field of an induction coil 1m x 1m	30 A/m, criteria A	30 A/m, criteria A	50 Hz, 1 A/m, criteria A

4.7 Voltage dips, fluctuations, and short-term interruptions

Test carried out in accordance with EN 61000-4-11	Limits in accordance with EN 61000-6-2	Limits in accordance with EN 61131-2
AC power inputs	Voltage dip 70% (30% reduction), 0.5 periods, criteria B	-
AC power inputs	Voltage dip 40% (60% reduction), 5 periods, criteria C	-
AC power inputs	Voltage dip 40% (60% reduction), 50 periods, criteria C	-
AC power inputs	Voltage dip <5% (>95% reduction), 250 periods, criteria C	-
AC power inputs	-	20 interruptions, 0.5 periods, criteria A
DC mains inputs	-	20 interruptions for 10 ms, <UN - 15%, criteria A

4.8 Damped vibration

Test carried out in accordance with EN 61000-4-12	Limits in accordance with EN 61131-2
Mains inputs/outputs, L to L	±1 kV, 1 MHz, repeat rate 400/seconds, length 2 seconds, connection lengths 2 m, criteria B
Mains inputs/outputs, L to PE	±2.5 kV, 1 MHz, repeat rate 400/seconds, length 2 seconds, connection lengths 2 m, criteria B

5 Mechanical conditions

Vibration	Test carried out in accordance with	Limits in accordance with
Vibration operation	EN 60068-2-6	EN 61131-2: Programmable logic controllers
Vibration during transport (packaged)	EN 60068-2-6	EN 60721-3-3 class 3M4
		EN 60721-3-2 class 2M1
		EN 60721-3-2 class 2M2
		EN 60721-3-2 class 2M3
Shock during operation	EN 60068-2-27	EN 61131-2: Programmable logic controllers
Shock during transport (packaged)	EN 60068-2-27	EN 60721-3-3 class 3M4
		EN 60721-3-2 class 2M1
		EN 60721-3-2 class 2M2
		EN 60721-3-2 class 2M3
Toppling (packaged)	EN 60068-2-31	B&R
		EN 60721-3-2 class 2M1
		EN 60721-3-2 class 2M2
		EN 60721-3-2 class 2M3
Free fall (packaged)	EN 60068-2-32	EN 61131-2: Programmable logic controllers
		B&R

5.1 Vibration operation

Test carried out in accordance with EN 60068-2-6	Limits in accordance with EN 61131-2		Limits in accordance with EN 60721-3-3 class 3M4	
Vibration during operation: Uninterrupted duty with movable frequency in all 3 axes (x, y, z), 1 octave per minute	10 sweeps for each axis		10 sweeps for each axis	
	Frequency	Limit value	Frequency	Limit value
	5 to 9 Hz	Amplitude 3.5mm	2 to 9 Hz	Amplitude 3mm
	9 to 150 Hz	Acceleration 1 g	9 to 200 Hz	Acceleration 1 g

5.2 Vibration during transport (packaged)

Test carried out in accordance with EN 60068-2-6	Limits in accordance with EN 60721-3-2 class 2M1		Limits in accordance with EN 60721-3-2 class 2M2		Limits in accordance with EN 60721-3-2 class 2M3	
Vibration during transport: Uninterrupted duty with movable frequency in all 3 axes (x, y, z)	10 sweeps for each axis, packaged		10 sweeps for each axis, packaged		10 sweeps for each axis, packaged	
	Frequency	Limit value	Frequency	Limit value	Frequency	Limit value
	2 to 9 Hz	Amplitude 3.5mm	2 to 9 Hz	Amplitude 3.5mm	2 to 8 Hz	Amplitude 7.5mm
	9 to 200 Hz	Acceleration 1 g	9 to 200 Hz	Acceleration 1 g	8 to 200 Hz	Acceleration 2 g
	200 to 500 Hz	Acceleration 1.5 g	200 to 500 Hz	Acceleration 1.5 g	200 to 500 Hz	Acceleration 4 g

5.3 Shock during operation

Test carried out in accordance with EN 60068-2-27	Limits in accordance with EN 61131-2	Limits in accordance with EN 60721-3-3 class 3M4
Shock during operation: Pulse (half-sine) stress in all 3 axes (x, y, z)	Acceleration 15 g, duration 11 ms, 18 shocks	Acceleration 15 g, duration 11 ms

5.4 Shock during transport (packaged)

Test carried out in accordance with EN 60068-2-27	Limits in accordance with EN 60721-3-2 class 2M1	Limits in accordance with EN 60721-3-2 class 2M2	Limits in accordance with B&R
Pulse (half-sine) stress in all 3 axes (x, y, z)	Acceleration 10 g, duration 11 ms, 3 shocks each, packaged	Acceleration 30 g, duration 6 ms, 3 shocks each, packaged	Acceleration 30 g, duration 11 ms, 3 shocks each, packaged

5.5 Toppling

Test carried out in accordance with EN 60068-2-31	Limits in accordance with EN 60721-3-2 class 2M1		Limits in accordance with EN 60721-3-2 class 2M2		Limits in accordance with EN 60721-3-2 class 2M3	
Drop and topple	Devices: Drop/topple on each edge		Devices: Drop/topple on each edge		Devices: Drop/topple on each edge	
	Weight	Required	Weight	Required	Weight	Required
	<20 kg	Yes	<20 kg	Yes	<20 kg	Yes
	20 to 100 kg	-	20 to 100 kg	Yes	20 to 100 kg	Yes
	>100 kg	-	>100 kg	-	>100 kg	Yes

5.6 Free fall (packaged)

Test carried out in accordance with EN 60068-2-32	Limits in accordance with EN 61131-2		Limits in accordance with EN 60721-3-2 class 2M1		Limits in accordance with EN 60721-3-2 class 2M2		Limits in accordance with EN 60721-3-2 class 2M3		Limits in accordance with B&R	
	Weight	Height	Weight	Height	Weight	Height	Weight	Height	Weight	Height
Free fall	Devices with delivery packaging each with 5 fall tests		Devices packaged		Devices packaged		Devices packaged		Devices packaged	
	<10 kg	1.0 m	<20 kg	0.25 m	<20 kg	1.2 m	<20 kg	1.5 m	<40 kg	1 m
	10 to 40 kg	0.5 m	20 to 100 kg	0.25 m	20 to 100 kg	1.0 m	20 to 100 kg	1.2 m	-	-
	>40 kg	0.25 m	>100 kg	0.1 m	>100 kg	0.25 m	>100 kg	0.5 m	-	-
	Devices with product packaging each with 5 fall tests									
	Weight	Height								
	<10 kg	0.3 m								
	10 to 40 kg	0.3 m								
>40 kg	0.25 m									

6 Climate conditions

Temperature and humidity	Test carried out in accordance with	Limits in accordance with
Worst case operation	UL 508	UL 508: Industrial control equipment EN 61131-2: Programmable logic controllers
Dry heat	EN 60068-2-2	EN 61131-2: Programmable logic controllers
Cold	EN 60068-2-1	EN 61131-2: Programmable logic controllers
Large temperature fluctuations	EN 60068-2-14	EN 61131-2: Programmable logic controllers
Temperature fluctuations in operation	EN 60068-2-14	EN 61131-2: Programmable logic controllers
Humid heat, cyclic	EN 60068-2-30	EN 61131-2: Programmable logic controllers
Constant humid heat (storage)	EN 60068-2-3	EN 61131-2: Programmable logic controllers
Sprayed water (from the front)	NEMA 250 type 4X	UL 508 - NEMA 250 4X: Degrees of protection provided by enclosures (IP code)

6.1 Worst case operation

Test carried out according to UL 508	Limits in accordance with UL 508	Limits in accordance with EN 61131-2
Worst case during operation. Operation of the device with the max. ambient temperature specified in the data sheet at the max. specified load	3 hours at max. ambient temperature (min. 40°C) duration approx. 5 hours	3 hours at max. ambient temperature (min. 40°C) duration approx. 5 hours

6.2 Dry heat

Test carried out in accordance with EN 60068-2-2	Limits in accordance with EN 61131-2
Dry heat	16 hours at 70°C for 1 cycle, then 1 hour acclimatization and function testing, duration approx. 17 hours

6.3 Dry cold

Test carried out in accordance with EN 60068-2-1	Limits in accordance with EN 61131-2
Dry cold	16 hours at -40°C for 1 cycle, then 1 hour acclimatization and function testing, duration approx. 17 hours

6.4 Large temperature fluctuations

Test carried out in accordance with EN 60068-2-14	Limits in accordance with EN 61131-2
Large temperature fluctuations	3 hours at -40°C and 3 hours at 70°C for 2 cycles, then 2 hours acclimatization and function testing, duration approx. 14 hours

6.5 Temperature fluctuations in operation

Test carried out in accordance with EN 60068-2-14	Limits in accordance with EN 61131-2
Open devices: These can also have a housing and are installed in control cabinets	3 hours at 5°C and 3 hours at 55°C, 5 cycles, temperature gradient 3°C / min, the unit is occasionally supplied with voltage during testing, duration approximately 30 hours
Closed devices: These are devices whose data sheet specifies a surrounding housing (enclosure) with appropriate safety precautions	3 hours at 5°C and 3 hours at 55°C, 5 cycles, temperature gradient 3°C / min, the unit is occasionally supplied with voltage during testing, duration approximately 30 hours

6.6 Humid heat, cyclic

Test carried out in accordance with EN 60068-2-30	Limits in accordance with EN 61131-2
Alternating climate	24 hours at 25°C / 55°C and 97% / 83% RH, 2 cycles, then 2 hours acclimatization, function testing and insulation duration approx. 50 hours

6.7 Constant humid heat (storage)

Test carried out in accordance with EN 60068-2-3	Limits in accordance with EN 61131-2
Damp heat, constant (storage)	48 hours at 40°C and 92.5% RH, then insulation test within 3 hours, duration approx. 49 hours

6.8 Sprayed water (front side)

Test carried out in accordance with UL 508	Limits in accordance with NEMA 250 type 4X
Sprayed water (front side)	Sprayed with a 25.4 mm (diameter) nozzle Distance: 3 to 3.7 m (all angles), water volume: 246 liters/minute Duration: 48 seconds, 5 seconds minimum

7 Safety

Safety	Test carried out in accordance with	Limits in accordance with
Ground resistance	EN 61131-2	EN 60204-1: Electrical equipment of machines
		EN 61131-2: Programmable logic controllers
Insulation resistance		EN 60204-1: Electrical equipment of machines
High voltage	EN 60060-1	EN 61131-2: Programmable logic controllers
		UL 508: Industrial control equipment

7.1 Ground resistance

Test carried out in accordance with EN 61131-2	Limits in accordance with EN 60204-1 ¹⁾		Limits in accordance with EN 61131-2
Ground resistance: Housing (from any metal part to the ground terminal)	Smallest effective cross section of the protective ground conductor for the branch being tested	Maximum measured voltage drop at a test current of 10 A	Test current 30 A for 2 min, <0.1 Ω
	1.0 mm ²	3.3 V	
	1.5 mm ²	2.6 V	
	2.5 mm ²	1.9 V	
	4.0 mm ²	1.4 V	
	>6.0 mm ²	1.0 V	

1) See EN 60204-1:1997, page 62, table 9.

7.2 Insulation resistance

Test carried out	Limits in accordance with EN 60204-1 ¹⁾
Insulation resistance: Main circuits to protective ground conductor	>1 MΩ at 500 VDC

1) See EN 60204-1:1997, page 62, table 9.

7.3 High voltage

Test carried out in accordance with EN 60060-1	Limits in accordance with EN 61131-2 ¹⁾			Limits in accordance with UL 508			
	Input voltage	Test voltage			Input voltage	Test voltage	
		1.2 / 50 μs Peak voltage surge	AC, 1min	DC, 1 min		AC, 1min	DC, 1 min
High voltage: Primary circuit to secondary circuit and to protective ground circuit (transformers, coils, varistors, capacitors and components used to protect against overvoltage can be removed before the test)	0 to 50 VAC 0 to 60 VDC	850 V	510 V	720 V	≤50 V	500 V	707 V
	50 to 100 VAC 60 to 100 VDC	1360 V	740 V	1050 V	>50 V	1000 V + 2x U _N	1.414x (1000 V + 2x U _N)
	100 to 150 VAC 100 to 150 VDC	2550 V	1400 V	1950 V			
	150 to 300 VAC 150 to 300 VDC	4250 V	2300 V	3250 V			
	300 to 600 VAC 300 to 600 VDC	6800 V	3700 V	5250 V			
	600 to 1000 VAC 600 to 1000 VDC	10200 V	5550 V	7850 V			

1) See EN 61131-2:2003, page 104, table 59.

7.4 Voltage range

Test carried out in accordance with	Limits in accordance with EN 61131-2	
Supply voltage	Measurement value	Tolerance min/max
	24 VDC 48 VDC 125 VDC	-15% +20%
	24 VAC 48 VAC 100 VAC 110 VAC 120 VAC 200 VAC 230 VAC 240 VAC 400 VAC	-15% +10%

Table 24: Safety - Voltage range

8 Other tests

Other tests	Limits in accordance with
Protection	EN 60529: Degrees of protection provided by enclosures (IP code)
Mounting dimensions	B&R

8.1 Protection

Test carried out in accordance with	Limits in accordance with EN 60529	Limits in accordance with EN 60529
Meaning of protection of Operating materials	IP2x Protection against large solid foreign bodies = 12.5 mm diameter	IP6x Protection against large solid foreign bodies: dust-proof
Meaning of protection of personnel	IP2x Protection against touching dangerous parts with fingers	IP6x Protection against touching dangerous parts with conductor
Protection against water permeation with damaging consequences	IPx0 Not protected	IPx5 Protected against sprayed water

9 International certifications

B&R products and services comply with applicable standards. This includes international standards from organizations such as ISO, IEC and CENELEC, as well as national standards from organizations such as UL, CSA, VDE, ÖVE, etc. We are committed to ensuring the reliability of our products in an industrial environment.

Certifications	
Europe 	This mark certifies that all harmonized EN standards for the applicable directives have been met.

Chapter 6 • Accessories

1 Overview

Model number	Product ID	4PP065.0351-P74	4PP065.0351-X74	4PP065.0571-P74	4PP065.0571-X74	4PP065.0571-P74F	4PP065.0571-X74F	4PP065.IF10-1	4PP065.IF23-1	4PP065.IF24-1	4PP065.IF33-1	Page
Lithium batteries												
0AC201.91	Lithium batteries, 4 pc., 3 V / 950 mAh, button cell	•	•	•	•	•	•					98
4A0006.00-000	Lithium battery, 3 V / 950 mAh, button cell	•	•	•	•	•	•					
Connector for power supply												
0TB103.9	Connector, 24 VDC, 3-pin female, 3.31 mm ² screw clamps, protected against vibration by the screw flange	•	•	•	•	•	•					99
0TB103.91	Connector, 24 VDC, 3-pin female, 3.31 mm ² cage clamps, protected against vibration by the screw flange	•	•	•	•	•	•					
Terminal blocks for X2X Link interfaces												
0TB704.9	Terminal block accessory, 4-pin, screw clamps, 2.5 mm ²		•		•		•		•		•	101
0TB704.91	Terminal block accessory, 4-pin, cage clamps, 2.5 mm ²		•		•		•		•		•	
Slide-in labels for Power Panel keys												
4A0069.00-000	5 DIN A4 slide-in label templates, 14 fields for a total of 35 3.5" PP65 devices, CorelDraw template available online for download	•	•									102
4A0075.00-000	5 DIN A4 slide-in label templates, 16 fields for a total of 40 5.7" PP65 devices, CorelDraw template available online for download					•	•					
Data storage media												
0CFCRD.0512E.01	CompactFlash 512 MB extended temp.	•	•	•	•	•	•					102
0CFCRD.2048E.01	CompactFlash 2048 MB extended temp.	•	•	•	•	•	•					
5CFCRD.0512-06	CompactFlash 512 MB B&R (SLC)	•	•	•	•	•	•					
5CFCRD.1024-06	CompactFlash 1 GB B&R (SLC)	•	•	•	•	•	•					
5CFCRD.2048-06	CompactFlash 2 GB B&R (SLC)	•	•	•	•	•	•					
5CFCRD.4096-06	CompactFlash 4 GB B&R (SLC)	•	•	•	•	•	•					
5MMUSB.2048-01	USB 2.0 flash drive 2048 MB B&R	•	•	•	•	•	•					
PP65 interface modules												
4PP065.IF10-1	PP65 interface module, 1 RS232 interface	•	•	•	•	•	•					70
4PP065.IF23-1	PP65 interface module, 1 RS232/RS485/RS422 interface (RS422: electrically isolated, RS485: electrically isolated and network-capable), 1 CAN interface (electrically isolated and network-capable). Order 0TB704 terminal block separately.	•	•	•	•	•	•					72
4PP065.IF24-1	PP65 interface module, 1 PROFIBUS DP slave interface (electrically isolated and network-capable), 1 RS232/RS422/RS485 interface (RS422/RS485: electrically isolated and network-capable)	•	•	•	•	•	•					76
4PP065.IF33-1	PP65 interface module, 2 CAN interfaces (electrically isolated and network-capable). Order 0TB704 terminal block separately.	•	•	•	•	•	•					80
Accessories for interface modules												
0G0001.00-090	PC - PLC/PW cable, RS232, online cable							•	•	•		
0AC913.93	Bus adapter, CAN, 2 CAN interfaces, including 30 cm attachment cable (TB704)								•		•	
0G1000.00-090	Bus connector, RS485, for PROFIBUS networks									•		

2 Replacement batteries

The lithium battery is needed to buffer the real-time clock and SRAM data.

The battery is subject to wear and must be replaced when the battery power is insufficient ("Bad" status) (see "Replacing the battery" on page 104).

2.1 Order data

Model number	Short description	Figure
	Batteries	
0AC201.91	Lithium batteries 4 pcs., 3 V / 950 mAh button cell	
4A0006.00-000	Lithium battery, 3 V / 950 mAh, button cell	

Table 25: 0AC201.91, 4A0006.00-000 - Order data

2.2 Technical data

Information:

The following characteristics, features and limit values only apply to this accessory and can deviate from those specified for the complete system. The data specifications for the complete system take precedence over those of individual components.

The technical data in this manual is current as of its creation/publication. We reserve the right to make changes.

Model number	0AC201.91	4A0006.00-000
General information		
Storage time	Max. 3 years at 30°C	
Certifications		
CE	Yes	
UL	cULus E115267 Industrial control equipment	
Electrical properties		
Capacity	950 mAh	
Self-discharge	<1% per year (at 23°C)	
Voltage range	3 V	
Operating conditions		
Pollution degree per EN 61131-2	Pollution degree 2	
Ambient conditions		
Temperature		
Storage	-20 to 60°C	
Relative humidity		
Operation	0 to 95%	
Storage	0 to 95%	
Transport	0 to 95%	

Table 26: 0AC201.91, 4A0006.00-000 - Technical data

2.3 Contents of delivery

Quantity	Component
1 or 4	Lithium batteries

Table 27: 0AC201.91, 4A0006.00-000 - Contents of delivery

3 TB103 3-pin power supply connector

This single-row 3-pin terminal block is used to connect the power supply.

3.1 Order data

Model number	Short description	Figure
0TB103.9	Connector 24 VDC - 3-pin, female - Screw clamp terminal block 3.31 mm ²	
0TB103.91	Connector 24 VDC - 3-pin, female - Cage clamp terminal block 3.31 mm ²	

Table 28: 0TB103.9, 0TB103.91 - Order data

3.2 Technical data

Information:

The following characteristics, features and limit values only apply to this accessory and can deviate from those specified for the complete system. The data specifications for the complete system take precedence over those of individual components.

The technical data in this manual is current as of its creation/publication. We reserve the right to make changes.

Model number	0TB103.9	0TB103.91
General information		
Certifications		
CE	Yes	
UL	cULus E115267 Industrial control equipment	
HazLoc	cULus HazLoc E180196 Industrial control equipment for hazardous locations	
DNV GL	Class I, Division 2, Groups ABCD, T4 ¹⁾ Temperature: B (0 - 55°C) Humidity: B (up to 100%) Vibration: A (0.7 g) EMC: B (bridge and open deck) ²⁾	
EAC	Yes	
Terminal block		
Note	Protected against vibration by the screw flange Nominal values according to UL	
Number of pins	3 (female)	
Type of terminal block	Screw clamp terminal block	Cage clamp terminal block ³⁾
Cable type	Only copper wires (no aluminum wires!)	
Pitch	5.08 mm	
Connection cross section		
AWG wire	26 to 14 AWG	26 to 12 AWG
Wire end sleeves with plastic covering	0.20 to 1.50 mm ²	
Solid wires	0.20 to 2.50 mm ²	
Fine-stranded wires	0.20 to 1.50 mm ²	0.20 to 2.50 mm ²
With wire end sleeves	0.20 to 1.50 mm ²	
Tightening torque	0.4 Nm	-
Electrical properties		
Nominal voltage	300 V	
Nominal current ⁴⁾	10 A / contact	
Contact resistance	≤5 mΩ	
Operating conditions		
Pollution degree per EN 61131-2	Pollution degree 2	

Table 29: 0TB103.9, 0TB103.91 - Technical data

- 1) Yes, although applies only if all components installed within the complete system have this certification and the complete system itself carries the corresponding mark.
- 2) Yes, although applies only if all components installed in the complete system have this certification and are listed on the associated DNV GL certificate for the product family.
- 3) Cage clamp terminal blocks cannot be used side-by-side.
- 4) The limit data for each I/O module must be taken into consideration.

3.3 Contents of delivery

Quantity	Component
1	Power connector in desired design.

Table 30: 0TB103.9, 0TB103.91 - Contents of delivery

4 TB704 4-pin X2X Link connector

This single-row 4-pin terminal block is needed as a terminal for the X2X Link interface.

4.1 Order data

Model number	Short description	Figure
0TB704.9	Accessory terminal block, 4-pin, screw clamp terminal block 2.5 mm ²	
0TB704.91	Accessory terminal block, 4-pin, push-in terminal block 2.5 mm ²	

Table 31: 0TB704.9, 0TB704.91 - Order data

4.2 Technical data

Information:

The following characteristics, features and limit values only apply to this accessory and can deviate from those specified for the complete system. The data specifications for the complete system take precedence over those of individual components.

The technical data in this manual is current as of its creation/publication. We reserve the right to make changes.

Model number	0TB704.9	0TB704.91
General information		
Certifications		
CE	Yes	
UL	cULus E115267 Industrial control equipment	
EAC	Yes	
Terminal block		
Note	Nominal values per UL	
Number of pins	4	
Type of terminal block	Screw clamp terminal block	Push-in terminal block ¹⁾
Cable type	Only copper wires (no aluminum wires!)	
Pitch	5.08 mm	
Connection cross section		
AWG wire	26 to 12 AWG	
Wire end sleeves with plastic covering	0.20 to 1.50 mm ²	
Solid wires	0.20 to 2.50 mm ²	
Fine-stranded wires	0.20 to 1.50 mm ²	0.20 to 2.50 mm ²
With wire end sleeves	0.20 to 1.50 mm ²	
Electrical properties		
Nominal voltage	300 V	
Nominal current ²⁾	10 A / contact	
Contact resistance	≤5 mΩ	

Table 32: 0TB704.9, 0TB704.91 - Technical data

- 1) Push-in terminal blocks cannot be used side-by-side.
- 2) The respective limit data of the I/O modules must be taken into account!

4.3 Contents of delivery

Quantity	Component
1	Terminal in desired design.

Table 33: 0TB704.9, 0TB704.91 - Contents of delivery

5 Slide-in label templates

Printable slide-in labels (A4 format) can be ordered from B&R:

Model number	Description
4A0069.00-000	5 DIN A4 slide-in label templates, 14 fields for a total of 35 3.5" PP65 devices, CorelDraw template available online for download
4A0075.00-000	5 DIN A4 slide-in label templates, 16 fields for a total of 40 5.7" PP65 devices, CorelDraw template available online for download

Table 34: 4A0069.00-000, 4A0075.00-000 - Order data

Power Panel devices with keys are delivered with slide-in labels, some of which are already captioned (F1, F2, etc.). The slide-in label slots are accessible on the back of the Power Panel device.

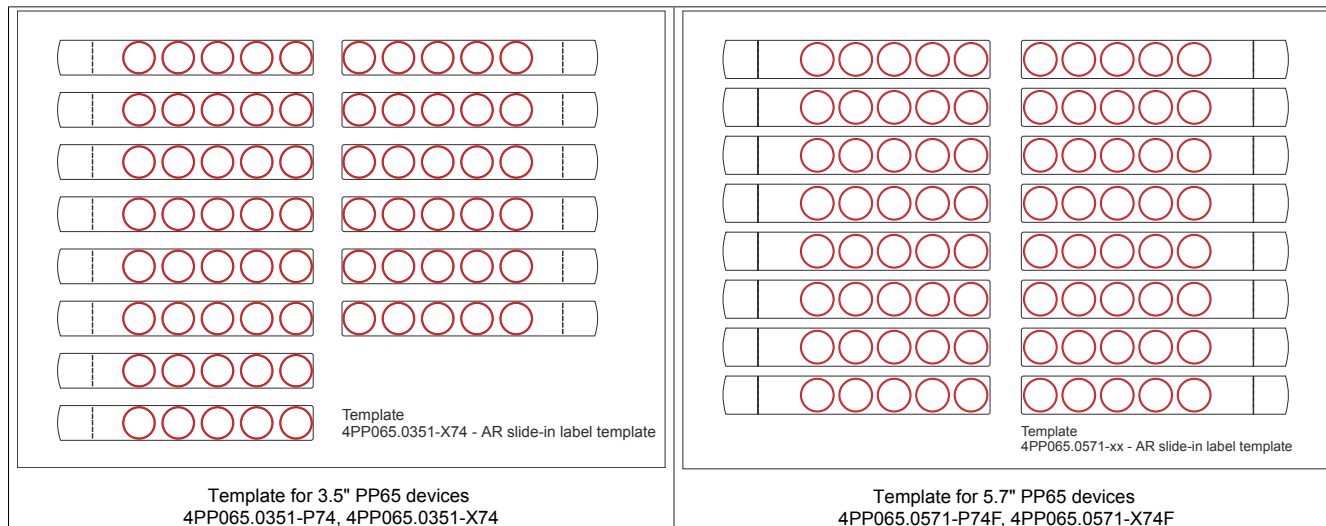

Table 35: 4A0069.00-000, 4A0075.00-000 - Slide-in label templates

Templates can be printed using a standard laser printer (b/w or color) in a temperature range from -40 to 125°C. A template for printing slide-in labels in CorelDRAW versions 7, 9 and 10 is available for download from the B&R website www.br-automation.com.

6 Data storage media

For technical data and additional information about storage media, see the corresponding documentation. This can be downloaded from the B&R website (www.br-automation.com) under the respective order number of the storage medium.

Chapter 7 • Maintenance

1 Cleaning

Danger!

Power Panel devices are only permitted to be cleaned while switched off in order to prevent unintended functions from being triggered when handling the touch screen or pressing keys.

Power Panel devices should be cleaned with a moist cloth. The cloth should be moistened with water and detergent, a screen cleaning agent or alcohol (ethanol). The cleaning agent should be applied to the cloth beforehand, not sprayed directly on the Power Panel! Never use aggressive solvents, chemicals, scouring agents, pressurized air or steam-jet air ejectors.

Notice!

Cleaning the label on the back of the unit is only permitted with a dry cloth. This ensures readability of the thermal print during the service life of the device.

Information:

The display with the touch screen should be cleaned at regular intervals.

2 Replacing the battery

2.1 General information

The battery buffers the internal real-time clock (RTC) and SRAM data (remanent and permanent variables, User RAM). The battery's buffer time is at least 3 years (at 50°C, 18.5 µA for the components being supplied and a self-discharge of 40%).

It is only necessary to replace the battery on devices with a lithium battery (see the technical data for the Power Panel device).

2.2 Evaluating the battery status

The status of the battery is determined immediately after the Power Panel is started and subsequently checked by the system every 24 hours. During this measurement, the battery is subjected to a brief load (approximately 1 second) and then evaluated. Once determined, the battery status can be read in a customer application using the *BatteryStatusCPU* data point or the *HwGetBatteryInfo* function (*AsHW* library).

Battery status	Function
OK	Data buffering is intact.
BAD	From the point when battery capacity is recognized as insufficient (BAD), data buffering is intact for approximately another 500 hours

Table 36: Battery status

Information:

The battery should only be replaced by qualified personnel.

2.3 Technical data

see "Replacement batteries" on page 98.

2.4 Procedure for replacing the battery

- Disconnect the power supply to the Power Panel.
- Touch the housing or ground connection in order to discharge any electrostatic charge from your body.
- Remove the battery cover from the top of the Power Panel device using a screwdriver (1).

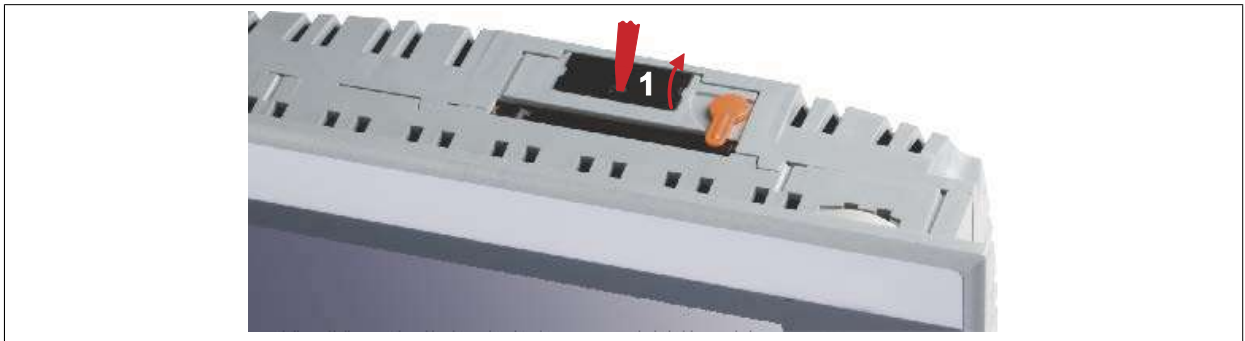

Figure 2: Replacing the battery - Removing the battery cover

- Carefully remove the used battery from its fitting by pulling the removal strip (2).

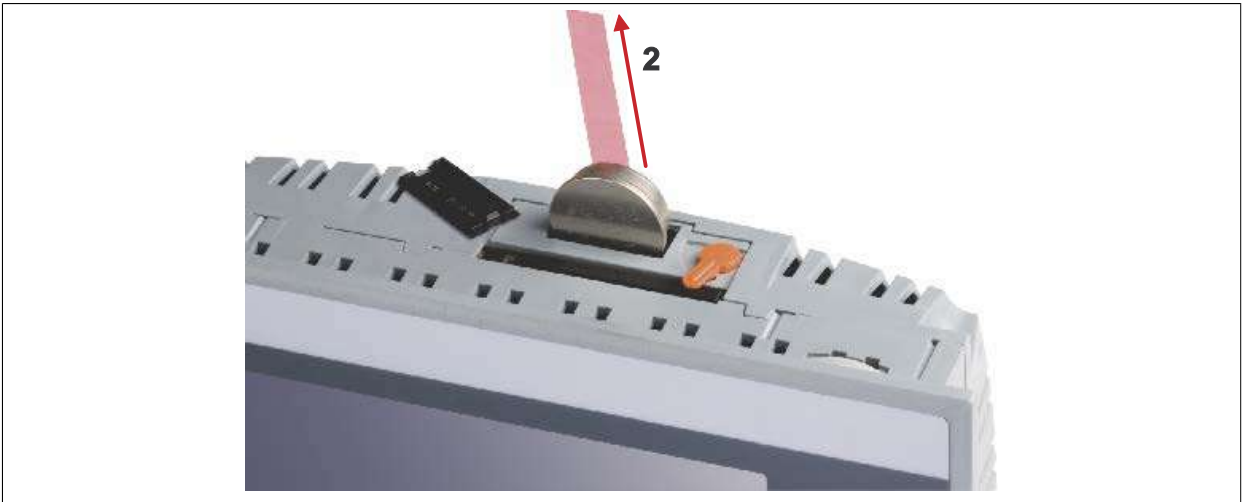

Figure 3: Replacing the battery - Removing the battery

- In order to prevent a short circuit, do not touch the new battery with pliers or uninsulated tweezers. The battery should not be held by its edges.

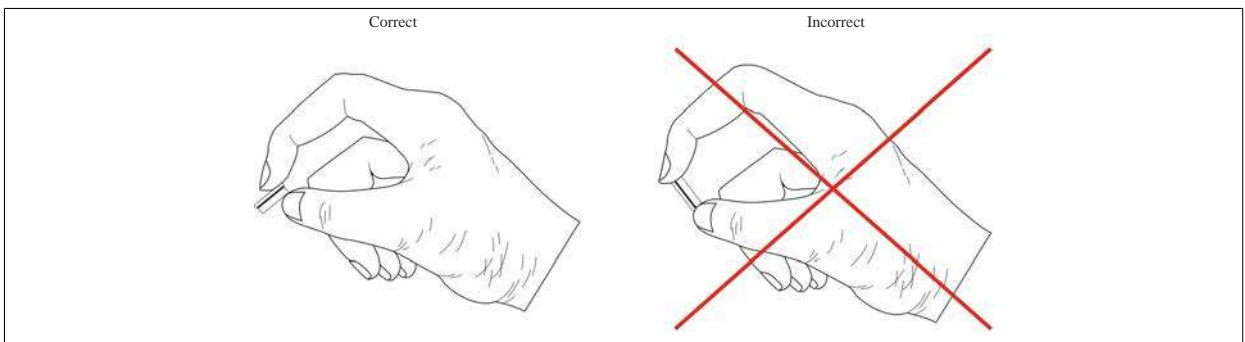

Figure 4: Replacing the battery - Handling the battery

- Insert the new battery with the correct polarity. To make the next battery change easier, be sure the removal strip is in place when inserting the battery.
- Replace the battery cover.
- Reconnect the power supply to the Power Panel.
- Reset the date and time (using B&R Automation Studio).

Warning!

Lithium batteries are considered hazardous waste. Used batteries should be disposed of in accordance with applicable local regulations.

3 Replacing the CompactFlash card

3.1 Removing the CompactFlash card

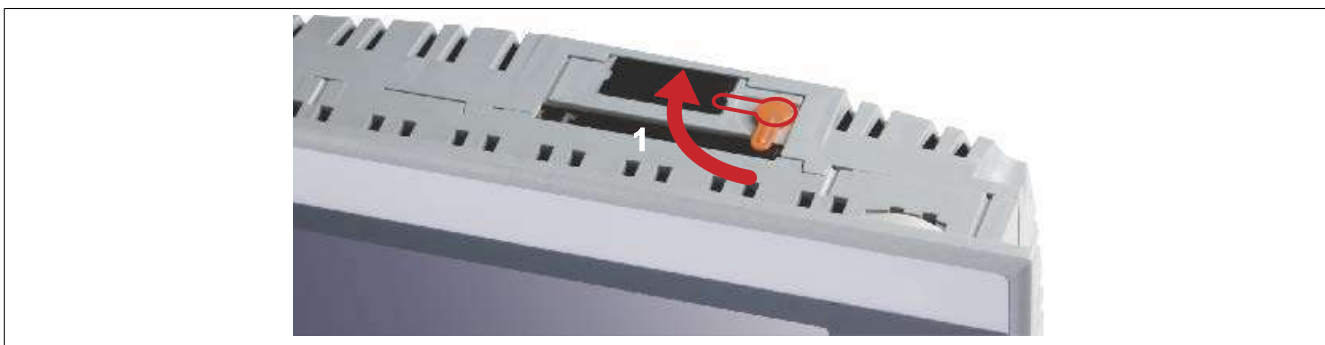

Figure 5: Removing the CompactFlash card - Opening the safety latch

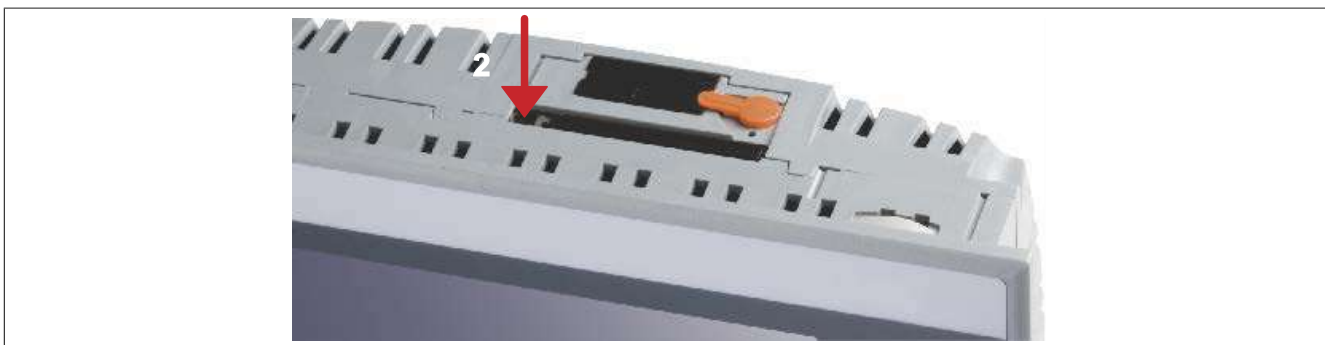

Figure 6: Removing the CompactFlash card - Pressing the ejection lever

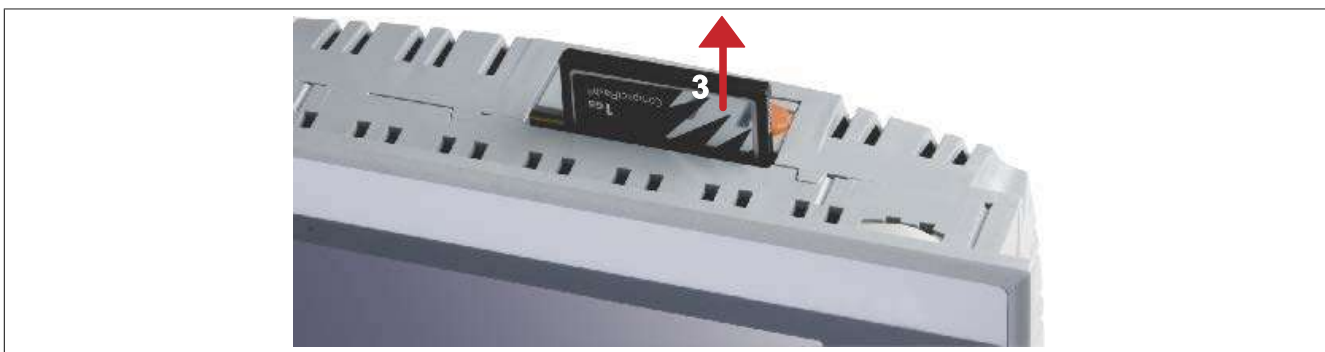

Figure 7: Removing the CompactFlash card - Taking out the CompactFlash card

Rotate the orange CompactFlash safety latch away from the CompactFlash slot (1). Then press the CompactFlash ejection lever (2) with a screwdriver until the CompactFlash card is ejected. The CompactFlash card can now be removed by hand (3).

3.2 Inserting the CompactFlash card

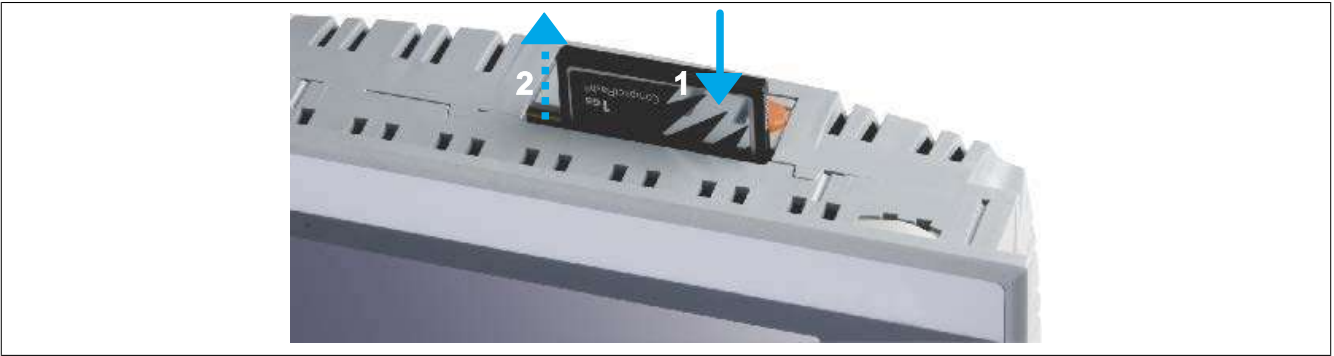

Figure 8: Installing the CompactFlash card - Inserting the CompactFlash card

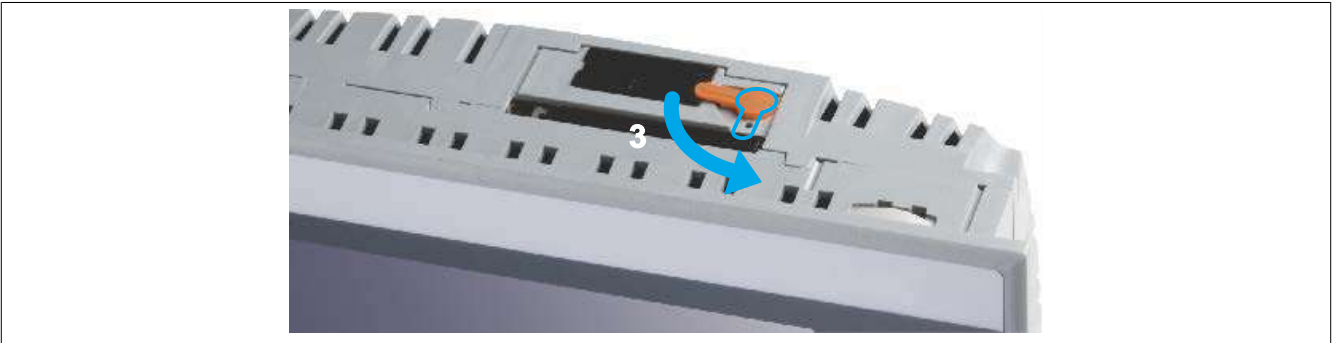

Figure 9: Installing the CompactFlash card - Rotating the safety latch

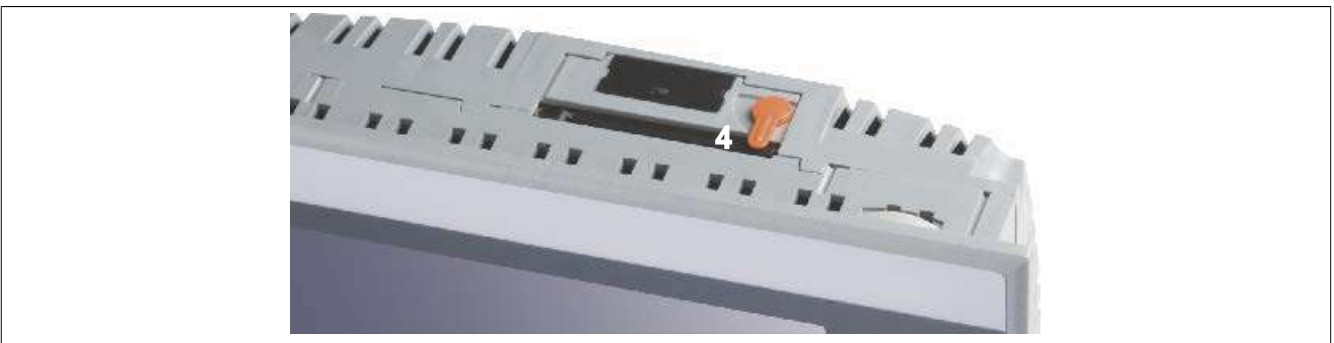

Figure 10: Installing the CompactFlash card - Final position of the safety latch

Insert the CompactFlash card by hand (contact side first) into the CompactFlash slot until it is flush with the front of the device (1). This will push the ejection lever out to the same level (2). The CompactFlash slot is mechanically designed to prevent the card from being inserted incorrectly. If inserted incorrectly, the CompactFlash card will not go in all the way and the ejection lever will not extend out. Finally, rotate the safety latch over the CompactFlash slot (3) to secure the CompactFlash card (4).

4 Preventing screen burn-in on LCD/TFT displays

Screen burn-in (afterimages, display memory effect, image retention or image sticking) occurs on LCD/TFT displays if a static image is displayed for a prolonged period of time. This static screen content causes the build-up of parasitic capacitances within the LCD components that prevent liquid crystal molecules from returning to their original state. This condition is unpredictable and can depend on the following factors:

- Type of image displayed
- Color composition of the image
- Length of time that the image is displayed
- Ambient temperature

4.1 How can this be avoided?

There is no perfect solution. There are ways to significantly reduce this effect, however:

- Avoid static images or screen content.
- Use screensavers (animated) if the display is not in use.
- Frequent picture change
- Turn off the display when not in use.

Turning off the backlight does not help prevent screen burn-in.

Chapter 8 • Environmentally friendly disposal

All programmable logic controllers, operating and monitoring devices and uninterruptible power supplies from B&R are designed to have as little impact on the environment as possible.

1 Separation of materials

To ensure that devices can be recycled in an environmentally friendly manner, it is necessary to separate out the different materials.

Component	Disposal
Programmable logic controllers Operating and monitoring devices Uninterruptible power supplies Batteries and rechargeable batteries Cables	Electronics recycling
Paper/Cardboard packaging	Paper/Cardboard recycling
Plastic packaging material	Plastic recycling

Disposal must be carried out in accordance with applicable legal regulations.

Chapter 9 • Abbreviations

1 General information

Abbreviations appear throughout the user's manual, for example in data tables or descriptions of pinouts.

2 Overview

Abbreviations	Stands for	Description
NC	Normally closed	A normally closed relay contact
	Not connected	Used in pinout descriptions if a terminal or pin is not connected to a module
ND	Not defined	In data tables, this stands for a value that has not been defined, for example because a cable manufacturer does not provide certain technical data.
NO	Normally open	A normally open relay contact
TBD	To be defined	Used in technical data tables when certain information is not yet available. The value will be provided later.

Table 37: Abbreviations used in this user's manual

0AC201.91.....	98
0TB103.9.....	99
0TB103.91.....	99
0TB704.9.....	101
0TB704.91.....	101
4A0006.00-000.....	98
4PP065.0351-P74.....	19
4PP065.0351-X74.....	28
4PP065.0571-P74.....	36
4PP065.0571-P74F.....	52
4PP065.0571-X74.....	45
4PP065.0571-X74F.....	61
4PP065.IF10-1.....	70
4PP065.IF23-1.....	72
4PP065.IF24-1.....	76
4PP065.IF33-1.....	80