

**MITSUBISHI
ELECTRIC**

Changes for the Better

for a greener tomorrow



Mitsubishi Graphic Operation Terminal
GOT1000 Series

**Tailored solutions to meet your HMI and
visualization needs**



GRAPHIC OPERATION TERMINAL

GOT1000

Compatible with
Windows® 7

CONTENTS

LINE-UP 4

CASE STUDY 1 6

Have you ever needed an HMI to do more than provide pretty panel meters? The GOT1000 does more than just visualization, it provides solutions for both the everyday, and not so everyday problem.

CASE STUDY 2 10

Solutions for your FA Device: Innovative solutions for improving uptime, work efficiency and productivity using the GOT1000 and your FA equipment.

Hardware Features 22

Software Features 26

GT SoftGOT1000

GT Works3

Function Index 30

Specifications, External Dimensions, etc. 52

GOT Solutions

FA Solutions

Robot



Servo system



CNC



Programmable controller



Inverter



Vision system



The GOT1000 delivers the competitive advantage:

The speed of your business and the speed of your machine hinges on many forces outside of your control.

The GOT1000 brings them back under control with speed, performance and industry leading functions that are tailored for visualization - real life solutions for your real time process.

Whether your focus is centered on uptime, productivity or serviceability there is a GOT solution that fits your machine, factory and enterprise level requirements.



GOTs evolve the face of control.

GRAPHIC OPERATION TERMINAL
GOT1000

The GOT1000 series offers six classes of terminals to fit any system or budget requirement.

High performance models with multimedia and a host of features and functions including embedded communications

GT16

GOT1000 GRAPHIC OPERATION TERMINAL

Multimedia Video RGB Network Bus Serial

15" type



XGA TFT (High-brightness, wide viewing angle)
GT1695M-XTBA AC type GT1695M-XTBD DC type
Resolution: 1024 x 768 Display colors: 65,536 colors
Multimedia, video/RGB model

12.1" type



SVGA TFT (High-brightness, wide viewing angle)
GT1685M-STBA AC type GT1685M-STBD DC type
Resolution: 800 x 600 Display colors: 65,536 colors
Multimedia, video/RGB model

10.4" type



SVGA TFT (High-brightness, wide viewing angle)
GT1675M-STBA AC type GT1675M-STBD DC type
Resolution: 800 x 600 Display colors: 65,536 colors
Multimedia, video/RGB model

VGA TFT
GT1675-VNBA AC type GT1675-VNBD DC type
Resolution: 640 x 480 Display colors: 4,096 colors

8.4" type



SVGA TFT (High-brightness, wide viewing angle)
GT1665M-STBA AC type GT1665M-STBD DC type
Resolution: 800 x 600 Display colors: 65,536 colors
Multimedia, video/RGB model

VGA TFT
GT1662-VNBA AC type GT1662-VNBD DC type
Resolution: 640 x 480 Display colors: 16 colors

5.7" type

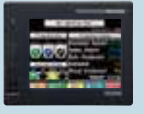

VGA TFT (High-brightness, wide viewing angle)
GT1655-VTBD DC type
Resolution: 640 x 480 Display colors: 65,536 colors

6.5" type Handy



VGA Handy GOT/TFT (High-brightness, wide viewing angle)
GT1665HS-VTBD DC type
Resolution: 640 x 480 Display colors: 65,536 colors

Performance models ideal for a wide range of applications in a network or standalone environment

GT15

GOT1000 GRAPHIC OPERATION TERMINAL

Multimedia Video RGB Network Bus Serial

15" type



XGA TFT (High-brightness, wide viewing angle)
GT1595-XTBA AC type GT1595-XTBD DC type
Resolution: 1024 x 768 Display colors: 65,536 colors

12.1" type



SVGA TFT (High-brightness, wide viewing angle)
GT1585V-STBA AC type GT1585V-STBD DC type
Resolution: 800 x 600 Display colors: 65,536 colors
Video/RGB model

10.4" type

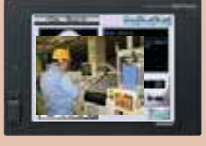

SVGA TFT (High-brightness, wide viewing angle)
GT1575V-STBA AC type GT1575V-STBD DC type
Resolution: 800 x 600 Display colors: 65,536 colors
Video/RGB model

VGA TFT (High-brightness, wide viewing angle)
GT1575-VTBA AC type GT1575-VTBD DC type
Resolution: 640 x 480 Display colors: 65,536 colors

VGA TFT
GT1575-VNBA AC type GT1575-VNBD DC type
Resolution: 640 x 480 Display colors: 256 colors

8.4" type



VGA TFT (High-brightness, wide viewing angle)
GT1565-VTBA AC type GT1565-VTBD DC type
Resolution: 640 x 480 Display colors: 65,536 colors

VGA TFT
GT1562-VNBA AC type GT1562-VNBD DC type
Resolution: 640 x 480 Display colors: 16 colors

5.7" type



VGA TFT (High-brightness, wide viewing angle)
GT1555-VTBD DC type
Resolution: 640 x 480 Display colors: 65,536 colors

OVGA STN
GT1555-QSBD DC type
Resolution: 320 x 240 Display colors: 4,096 colors

OVGA STN
GT1550-QLBD DC type
Resolution: 320 x 240 Display colors: 16 gray scales

Standard model with advanced features and communication interfaces

GT14

GOT1000 GRAPHIC OPERATION TERMINAL

Multimedia Video RGB Network Bus Serial

5.7" type



OVGA TFT (NEW)
GT1455-QTBDE DC type
Resolution: 320 x 240 Display colors: 65,536 colors

OVGA STN (NEW)
GT1450-QLBDE DC type
Resolution: 320 x 240 Display colors: 16 gray scales

Large basic models with integrated features and communication interfaces

GT12

GOT1000 GRAPHIC OPERATION TERMINAL

Multimedia Video RGB Network Bus Serial

10.4" type



VGA TFT
GT1275-VNBA AC type
Resolution: 640 x 480 Display colors: 256 colors

8.4" type



VGA TFT
GT1265-VNBA AC type
Resolution: 640 x 480 Display colors: 256 colors

Small models with a host of advanced functions

GT11

GOT1000 GRAPHIC OPERATION TERMINAL

Multimedia Video RGB Network Bus Serial

5.7" type Handy



OVGA Handy GOT/STN
GT1155HS-QSBD DC type
Resolution: 320 x 240 Display colors: 256 colors

GT1150HS-QLBD DC type
Resolution: 320 x 240 Display colors: 16 gray scales

Compact models with basic functions

GT10

GOT1000 GRAPHIC OPERATION TERMINAL

Multimedia Video RGB Network Bus Serial

5.7" type

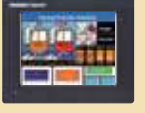

OVGA STN
GT1055-QSBD 24VDC type
Resolution: 320 x 240 Display colors: 256 colors

OVGA STN
GT1050-QBBD 24VDC type
Resolution: 320 x 240 Display colors: Monochrome (blue/white) 16 gray scales

4.7" type



OVGA STN
GT1045-QSBD 24VDC type
Resolution: 320 x 240 Display colors: 256 colors

OVGA STN
GT1040-QBBD 24VDC type
Resolution: 320 x 240 Display colors: Monochrome (blue/white) 16 gray scales

4.5" type



STN (High contrast)
GT1030-HBD [Black] 24VDC type RS-422 connection
GT1030-HBD2 [Black] 24VDC type RS-232 connection
GT1030-HBL [Black] 5VDC type RS-422 connection
GT1030-HWD [White] 24VDC type RS-422 connection
GT1030-HWD2 [White] 24VDC type RS-232 connection
GT1030-HWL [White] 5VDC type RS-422 connection
Resolution: 288 x 96 Display colors: Monochrome (black/white) (Tricolor LED (green/orange/red))

STN (High contrast)
GT1030-HBDW [Black] 24VDC type RS-422 connection
GT1030-HBDW2 [Black] 24VDC type RS-232 connection
GT1030-HBLW [Black] 5VDC type RS-422 connection
GT1030-HWDW [White] 24VDC type RS-422 connection
GT1030-HWDW2 [White] 24VDC type RS-232 connection
GT1030-HLWL [White] 5VDC type RS-422 connection
Resolution: 288 x 96 Display colors: Monochrome (black/white) (Tricolor LED (white/pink/red))

3.7" type



STN
GT1020-LBD [Black] 24VDC type RS-422 connection
GT1020-LBD2 [Black] 24VDC type RS-232 connection
GT1020-LBL [Black] 5VDC type RS-422 connection
GT1020-LWD [White] 24VDC type RS-422 connection
GT1020-LWD2 [White] 24VDC type RS-232 connection
GT1020-LWL [White] 5VDC type RS-422 connection
Resolution: 160 x 64 Display colors: Monochrome (black/white) (Tricolor LED (green/orange/red))

STN
GT1020-LBDW [Black] 24VDC type RS-422 connection
GT1020-LBDW2 [Black] 24VDC type RS-232 connection
GT1020-LBLW [Black] 5VDC type RS-422 connection
GT1020-LWDW [White] 24VDC type RS-422 connection
GT1020-LWDW2 [White] 24VDC type RS-232 connection
GT1020-LLWL [White] 5VDC type RS-422 connection
Resolution: 160 x 64 Display colors: Monochrome (black/white) (Tricolor LED (white/pink/red))

*: For details about the functions of GT10 models, see "GT10 (pages 48, 49)".

*: The GT16□□-VNBD□, GT1655-VTBD, GT1665HS-VTBD, GT145□, GT12□□-VNBD□ and GT1030 high contrast products (GT1030-H□□□□) are not supported by the screen design software GT Works2/GT Designer2.

GOT Solutions

Quick response to Comprehensive problems. Easy facility design with the GOT1000 series. solutions to production site problems.

CASE 1

Facility uptime is increased by reducing unexpected errors on the floor.

Before

Alarm light is on
Error!

What's wrong with it?
How do I deal with the problem?
What is the cause?

GOT Solution

One-Touch Ladder Jump function
The one touch function reduces equipment downtime by quickly checking equipment operation, machine status and logic with a single button.
For details, see [P.44](#)

When an error is detected, touch switch operations can search for and display the cause of the problem.

No need to go back to my desk to get my PC or check ladder programs!

<Error occurred in ST2 device!>
ST1 (Normal) ST2 (Error)
Error indicator light: Y10

Touch the switch to find how Y10 is set

When errors occur, touch the Search switch to automatically start up the Ladder Monitor Screen.

<Display ladder blocks including Y10>
ST1 error M10 Y10 Error indicator light: ON
ST2 error M20 Touch normally open contact (M20) in on state. (Coil search function)

<Display ladder blocks including M20>
Pusher LS error M31 Air pressure error M32 Oil pressure error M33
Error is detected because oil pressure (M33) is on.

CASE 2

Equipment availability is greatly improved when GOTs are used to quickly edit PLC programs.

Before

Sensor malfunction!
Part not being read by sensor
Check it with the ladder monitor function.
The device number is wrong.
Need to fix it now.
I need a PC...

GOT Solution

Ladder Editor function
It takes only a few touches to make minor ladder program corrections. It is easy and fast.
For details, see [P.45](#)

Repair is made easy and quick without a PC!

Correct

Change the device number from X10 to X20.

CASE 3

Downtime is shortened when debugging can be performed locally or over decentralized systems.

Before

2F Electrical Room Control panel
It's difficult to perform debugging without watching the machine in operation.
1F Equipment Floor
I'm not sure how the program is changed and if it's operating correctly.

GOT Solution

FA Transparent function
Use GOT to connect the PLC and PC. You can check the equipment and debug programs at the same time.
For details, see [P.39](#)

Touch panel operation is enabled even when a PC is connected. Both the GOT and PLC can be debugged in one single, efficient operation!

PLC debugging can be performed from a PC connected to the GOT!

2F Electrical Room
1F Equipment Floor
Operation panel

CASE 4

Production efficiency is maintained when the GOT is used to manage product changeovers and maintenance recovery plans.

Before

Warehouse Office
I need to go to the warehouse to get another PLC!
I also need to go to the office to get a PC.
PLC failed!
No battery!

GOT Solution

Backup/Restoration function
No need for a PC on the production floor - simply use the GOT to manage (Read/Write) and store PLC programs.
For details, see [P.42](#)

Speedy restoration! No need for a PC or locating the program.

It is OK, because the latest program was stored in the GOT.

Change CPU
Restore

GOT Solutions

CASE 5

Operator efficiency is improved when manuals and work instructions can be accessed directly from the display.

Before

Alarm light is on
Error!
Error B110

What is error B110?
Where is the manual?
How do I deal with the problem?
Call the maintenance representative?

GOT Solution

Document Display function/ Video Manual Playback

You can save necessary documents such as manuals in a memory card on the GOT.
For details, see [P.32](#) [P.33](#)

Work instructions are easy to access and written in a language that I can understand.

With the Document Display function, it's easy to read the manual by changing and scrolling through pages.

Directly assign documents and image files to touch switches.

The manual describes how to deal with the error displayed.

<Document display> <Video manual playback>

CASE 6

Production quality can be increased when using the GOT to capture and play back real time videos and images.

Before

Machine fails, forcing the line to stop!

That machine failed again...
How can I locate the cause of the problem in this unmanned, fully automated line?

GOT Solution

Multimedia function

Check the recorded view of the production line. You can find problem causes quickly.
For details, see [P.32](#)

I can use the GOT to capture the cause of this problem.

Attach a video camera on GOT. The view of the production line is recorded before and after the occurrence of a problem.

Play it on the GOT. High-resolution pictures are recorded and played in VGA resolution!

<120-second long video images are recorded before and after the occurrence of a problem.>

120-seconds-before 120-seconds-after

Trouble

CASE 7

Minimize production mistakes by using the GOT to manage authorization and security levels.

Before

Production failure!

- Checking the production data and timesheet information to identify the operator takes time.
- The operator's memory about the operation is too vague to identify the problem cause.

Who was working at that time? What was being operated and how?
I don't remember.

GOT Solution

Operator Authentication function + Operation Log function

Save operator information on a memory card along with operation records. You can find sources of trouble quickly.
For details, see [P.41](#)

You don't have to panic. The GOT will find the cause.

What is the cause of the defective product?

The operation log including the operator information is shown for analysis.

It is found that Jon Smith entered erroneous data.

History check screen

Product A Display alarm data
Product B Display operation log
Product C

We can determine the cause of the error and this will be helpful in improving operations and preventing a recurrence in the future.

CASE 8

Reduce installation costs by using flexible mounting options.

Before

Hardware switches and lamps may require large areas of boards.

Rearranging them and reconnecting cables may be inconvenient when specifications are changed.

GOT Solution

GT10 models (GT1020/GT1030)

For simple and small applications, GOT1000 compact types are just right.
For details, see [P.48](#)

Compact and easy-to-use, with simple wiring that reduces assembly time.

Its operation is intuitive. Three backlight colors indicate different equipment statuses.

green orange red
3-color display model
(white pink red)
3-color model is also available)

Both horizontal and vertical mounting available to meet the needs of different applications.

FA Solutions

Obstacles are often encountered when using many different types of FA devices. The following problems can be resolved by linking with GOT1000.

Enhancing sequence control.



General-purpose PLC
CASE 1 MELSEC x GOT1000

Powerful functionality that is useful during startup and the tuning process!

Can the program be debugged without opening the cabinet?

FA transparent function

For details, see P.39

Connected with a personal computer, the GOT acts as a transparent gateway to enable programming, start up, and adjustment of equipment using GX Works2 or GX LogViewer. Users do not have to bother with opening the cabinet or changing cable connections. (On the GT10 series, the FA transparent function can be used via the interface on the rear side.)

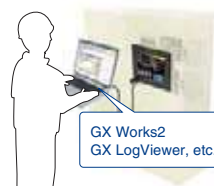

GX Works2
GX LogViewer, etc.

Can the PLC programs be recovered after failure?

Backup/restoration function

For details, see P.42

Sequence programs and parameters can be backed up to the memory card or USB memory in the GOT. Users can then perform batch operation to restore the data to the PLC.

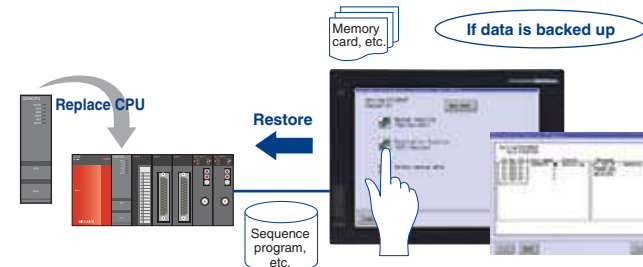

Can the PLC status or errors be checked quickly?

System monitor function

For details, see P.46

PLC devices can be monitored and changed.

Intelligent module monitor function

For details, see P.46

Buffer memory values and I/O information can be monitored and changed.

Network monitor function

For details, see P.46

Enable monitoring of network line conditions on a dedicated screen.

Network module status display

Enable monitoring of LED status, error status, among others of network modules on a GOT.

MELSEC-L troubleshooting function

For details, see P.46

A dedicated maintenance screen for the L series is included. The CPU status and error information can be easily confirmed without a personal computer. If a problem occurs, you can jump to a function screen such as the ladder monitor to quickly take corrective actions.



Ideal for PLCs in the field and on the plant floor!

Can PLC programs be monitored with the GOT?

Ladder monitor function and ladder editor function

For details, see P.44 P.45

Sequence programs can be monitored in a circuit diagram (ladder format).

SFC monitor function

For details, see P.44

The Q series (Q mode) SFC programs (MELSAP3, MELSAP-L) can be monitored in a SFC diagram format.

Can the root cause be easily identified?

One-touch ladder jump function

For details, see P.44

(Q/L/QnA series ladder monitor and ladder editor function)

By setting a program name and coil number of the PLC to a touch switch, the relevant ladder circuit block can be displayed directly. Troubles can be handled smoothly from the alarm screen.

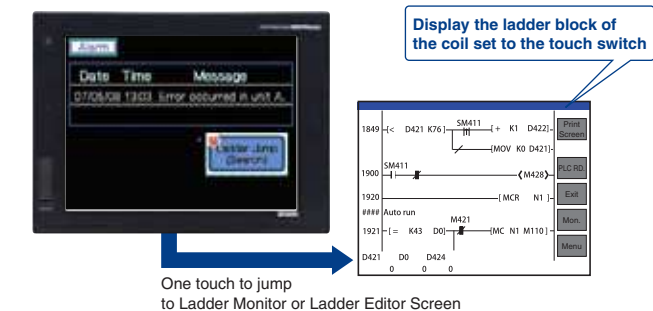

Display the ladder block of the coil set to the touch switch

One touch to jump to Ladder Monitor or Ladder Editor Screen

Can simple changes to ladder programs be made without a personal computer?

Ladder editor function

For details, see P.45

Sequence programs of the Q series (Q mode) and the L series can be edited in a circuit diagram (ladder format).

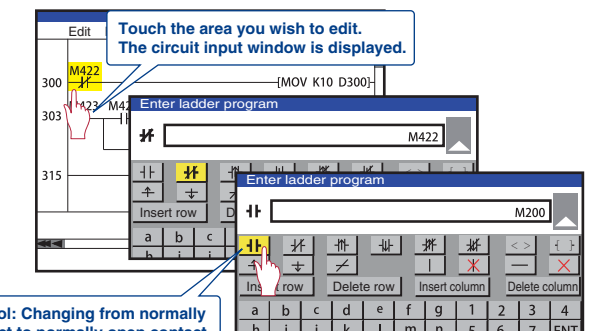

Circuit symbol: Changing from normally closed contact to normally open contact. Device: Changing from M422 to M200.

Using the MELSEC-L series or high-speed data logger module!

Can collected logging data be checked at the worksite?

Log viewer function

For details, see P.40

Logging data collected using the L series or high-speed data logger module can be displayed on the GOT.



Monitoring batch control!

Can Process and Batch monitoring be simplified?

Building a process control system using GOT1000

For details, see P.26 P.51

PX Developer creates GOT process control screens automatically. The automatically generated data can be used for both the GOT (worksite) and GT SoftGOT1000 (monitor room), and therefore monitor screens can be created efficiently.



FA Solutions

Making drive control even easier.



General-purpose AC Servo
 CASE2 MITSUBISHI SERVO AMPLIFIERS & MOTORS **MELSERVO X GOT1000**
 GRAPHIC OPERATION TERMINAL

Powerful functionality that is useful during startup and the tuning process!

Can the program be debugged without opening the cabinet?

FA transparent function

For details, see P.39

Connected with a personal computer, the GOT acts as a transparent gateway to enable programming, startup, and adjustment of equipment using MT Works2, GX Works2, GX Configurator-QP or MR Configurator2. Users do not have to bother with opening the cabinet or changing cable connections.



MT Works2
GX Works2, etc.

Can devices in the motion controller be validated?

System monitor function

For details, see P.46

Motion controller devices can be monitored and changed.

For direct connection of servo amplifiers to GOTs!

Can errors or the status of servo amplifiers be validated?

Servo amplifier monitor function

For details, see P.47

In a system which outputs pulse train, the GOT can be connected to a servo amplifier in a serial connection to perform the following operations: monitoring, alarm display, diagnosis, parameter setting, and test operations.

Item	Value	Unit	Alarm
Cumulative feedback pulses	-100.000	pulses	426300 pulses
Servo motor speed	0.0	rev/min	4027 rev
Drop status	1 pulse	Load to motor inertia ratio	7.00 times
Cumulative command pulse	0.0	Unit voltage	50 V
Command pulse frequency	0.0	Encoder internal temperature	50 °C
Actual speed command	-0.00	Settling time	2 ms
Average torque command voltage	0.00	Operating detection frequency	0 Hz
Regenerative load ratio	0%	Tough drive times	0 times
Effective load ratio	0%	Unit power consumption	30 W
Peak load ratio	0%	Unit total power consumption	50 W
Instantaneous current	0%		

Ideal for motion controllers in the field and on the plant floor!

Can the motion controller's servo parameters be changed easily?

Q series motion monitor function

For details, see P.47

The GOT enables easy monitoring of motion controllers (Q series), changing of servo parameters, and display of errors on the screen.

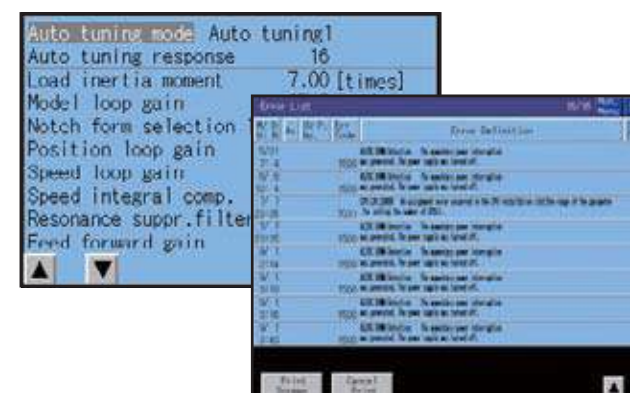

Can motion SFC programs be checked on the GOT?

Motion SFC monitor function

For details, see P.45

Motion controller (Q series) motion SFC programs can be monitored in SFC diagram format. Viewing the batch program monitor or the active step list enables you to see the complete status at a glance.

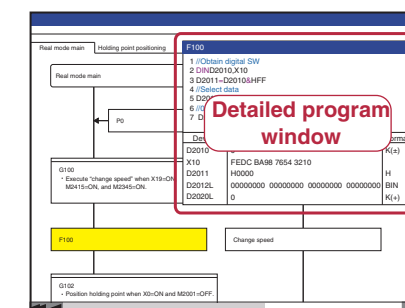

Can motion profiles be recovered after controller failures?

Backup/restoration function

For details, see P.42

Motion controller (Q series) programs and parameters can be backed up onto a memory card or USB memory in the GOT. Users can perform batch operation to restore the data to the motion controller.

Embedded functionality for positioning modules/simple motion modules!

Can positioning status and errors be validated?

Intelligent module monitor function

For details, see P.46

Buffer memory values of modules such as the QD77MS and I/O information can be monitored and changed.

Other convenient uses!

When used in combination with the FA transparent function, the positioning module/simple motion module can be efficiently debugged. If an error occurs in the positioning module/simple motion module, the details of the error can be confirmed using just the GOT.

Monitor the status, parameters, input/output information, and other data for each axis of the positioning module/simple motion module (intelligent module monitor function)

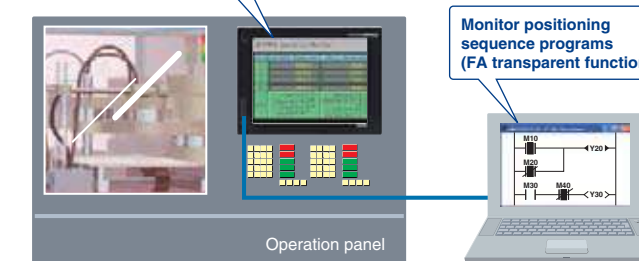

Monitor positioning sequence programs (FA transparent function)

Operation panel



FA Solutions

Simplifying inverter control.



General-purpose Inverter

CASE 3 FREQROL X GOT1000

Ideal for inverter startups and operation!

Can connections to the inverter be simplified?

Directly connect inverters

Up to 31 inverters can be connected to a single GOT over a total distance of 500m. FREQROL-A700 inverters can automatically configure the communication parameters for GOT connection, making connections easy.

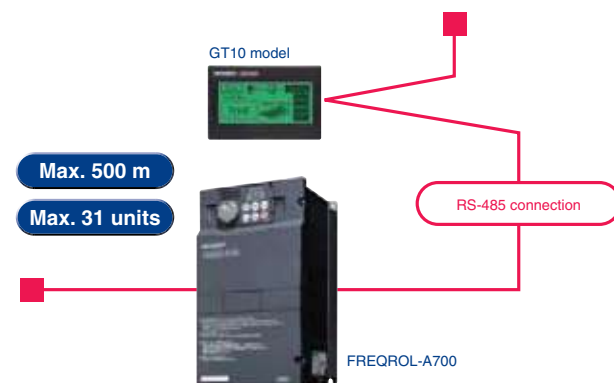

Can the parameters be checked or changed without opening the cabinet?

FA transparent function

For details, see P.39

Connected with a personal computer, the GOT acts as a transparent gateway to enable startup and adjustment of equipment using FR Configurator. Users do not have to bother with opening the cabinet or changing cable connections.

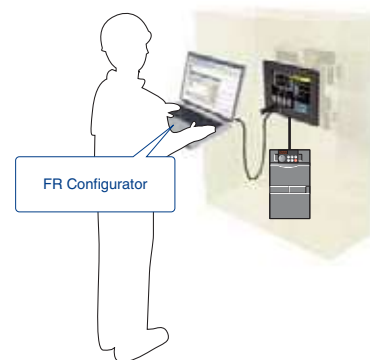

Ideal for inverter operation!

Can the inverter status be monitored on the GOT?

Example of GT16 operation screen



Easy-to-understand display

Operation commands and parameters can be set from a GOT. On the GT1020/GT1030, three different backlight colors can be switched between screens, making it easy for operators to read and operate the screens.

Example of GT1020 parameter screen



Example of GT1030 operation screen

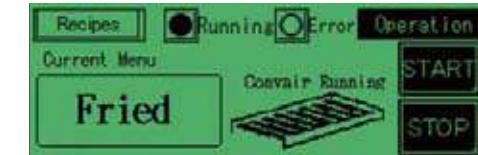

Can inverter parameters be changed easily?

Ready-to-use sample screens

Sample screen data for specifying parameters is available.

Parameter settings		
0 Torque boost	0123.5%	01 Acceleration/deceleration
1 Maximum frequency	012.45Hz	02 Acceleration/deceleration
2 Minimum frequency	012.45Hz	03 Inverter operation parameter
3 Base frequency	012.45Hz	04 Inverter operation parameter
4 Multi-speed setting (high speed)	012.45Hz	05 Multi-speed setting (speed 4)
5 Multi-speed setting (middle speed)	012.45Hz	06 Multi-speed setting (speed 5)
6 Multi-speed setting (low speed)	012.45Hz	07 Multi-speed setting (speed 6)
7 Acceleration time	0123.5%	08 Multi-speed setting (speed 7)
8 Deceleration time	0123.5%	09 Inverter frequency resolution
9 Electronic thermal relay	012.45%	10 Inverter frequency resolution
10 Electronic thermal relay	012.45%	11 Inverter frequency resolution
11 DC injection brake operation time	012.45%	12 Inverter frequency resolution
12 DC injection brake operation voltage	012.45%	13 Inverter frequency resolution
13 Start frequency	012.45%	14 Inverter frequency resolution
14 Load current selection	0123.5%	15 Inverter frequency resolution
15 Stop frequency	012.45%	16 Inverter frequency resolution
16 Inverter operation parameter	0123.5%	17 Inverter frequency resolution

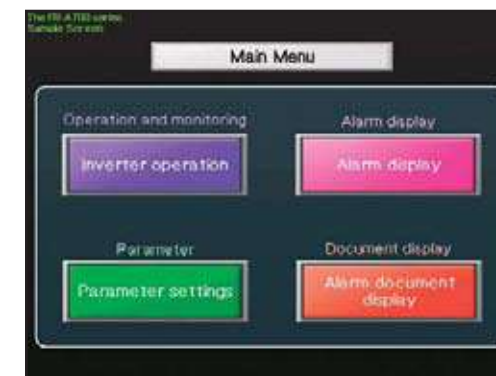

Alarm display	
Alarm information	
Latest alarm	E.O.C2
Second previous alarm	E.O.C2
Third previous alarm	E.O.C2
Fourth previous alarm	E.O.C2
Fifth previous alarm	E.O.C2
Sixth previous alarm	E.O.C2
Seventh previous alarm	E.O.C2
Eighth previous alarm	E.O.C2
-Latch monitor display-	
Set frequency (RAM)	012.34Hz
Output frequency	012.34Hz
Output current	0.12A
Output voltage	012.3V
Running speed	0123(r/min)
Regenerative brake duty	012.4%
Electronic thermal relay	012.4%
Motor excitation current	01.3A
Motor load factor	0123.5%
Motor output	012.45kW
Cumulative energization	01234 h

FA Solutions

Faster robot control!



Industrial Robot
CASE 4 MELFA X GOT1000

Powerful functions for robotic systems!

Can the teaching box and the personal computer used for setup be consolidated into a single unit?

Consolidate and centralize robot monitoring and control functions on production floor using the GOT

Even if a teaching box is not available, the GOT can be used to operate the robot and easily check the current position data and error details. Consolidating panel operations into the GOT improves operation and maintenance work efficiency.

- Robot internal information (data)
- Error information/Variable information/Program information
 - Robot information (current speed/attainment rate, etc.)
 - Maintenance information (battery/grease remaining time, etc.)
 - Servo motor (load rate/current value, etc.)

Immediately check the robot status!

- Operation and maintenance on the GOT
- Robot operation screen
 - Robot current position monitor screen
 - Load rate/current value display screen
 - Maintenance forecast screen

Consolidated panel operations



Ideal for robot programming!

Can the robot program be easily accessed?



Ready-to-use sample screens

Sample screen data is available for robot operation, current position monitoring, and other purposes. There is no need to create robot programs from scratch.



Robot operation panel screen



Robot jog/hand operation screen



Robot current position monitor screen

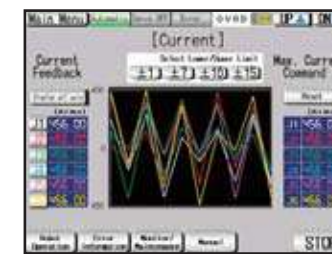

Robot load rate/current value monitor screen



Robot maintenance forecast screen

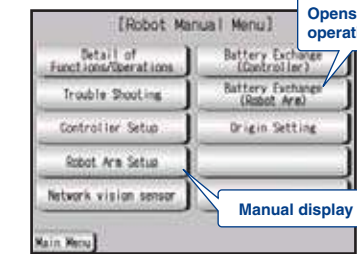

Robot manual menu screen

Opens a video of operation examples

Manual display

Can the program be debugged without opening the cabinet?



FA transparent function

For details, see P.39

Connected with a personal computer, the GOT acts as a transparent gateway to enable start up and adjustment of equipment using RT ToolBox2. Users do not have to bother with opening the cabinet or changing cable connections.

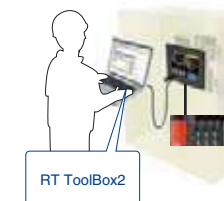

Can devices in the robot controller be validated?



System monitor function

For details, see P.46

Embedded monitoring utilities are available enabling users to view and change device values.

In the event of trouble!

Can robot profiles be recovered after controller failures?



Backup/restoration function

For details, see P.42

Robot controller data can be backed up to the memory card or USB memory in the GOT. Users can perform batch operation to restore the data to the robot controller.

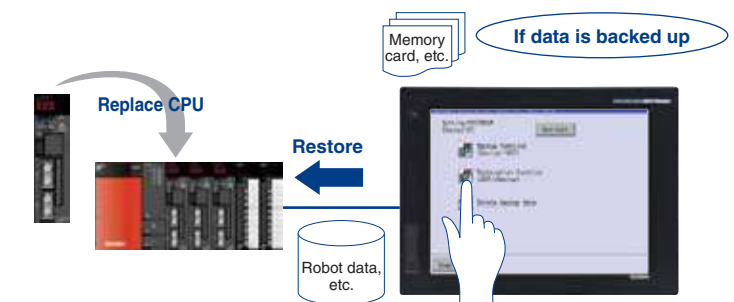

FA Solutions

Simplifying numerical control.



Numerical Control Unit
CASE5 C70 Series MITSUBISHI CNC
 GRAPHIC OPERATION TERMINAL
X GOT1000

Powerful function for CNC startup, machining and changeover!

Can CNC parameters be changed easily?



CNC monitor function

For details, see P.47

The CNC C70 can be monitored and the parameters can be changed.

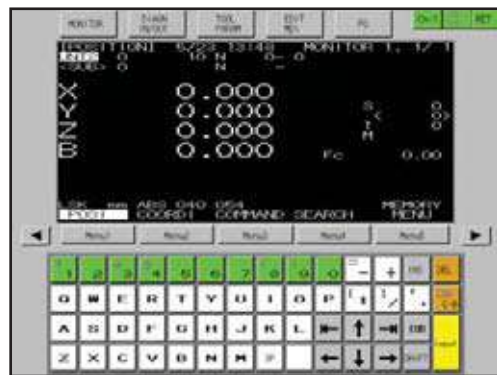

Can errors or the status of the CNC be validated quickly?



CNC data I/O function

For details, see P.47

Data, such as machining programs and parameters, can be copied from a GOT memory card or USB memory to the CNC C70 and vice versa. Data can be deleted as well.

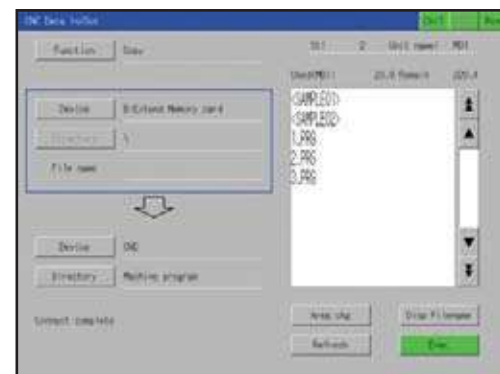

Can CNC devices be easily validated?



System monitor function

For details, see P.46

Embedded monitoring utilities are available enabling users to view and change CNC C70 device values.

Can the parameters be checked or changed without opening the panel?



FA transparent function

For details, see P.39

Connected with a personal computer, the GOT acts as a transparent gateway to specify and adjust parameters of equipment using NC Configurator. Users do not have to bother with opening the cabinet or changing cable connections.

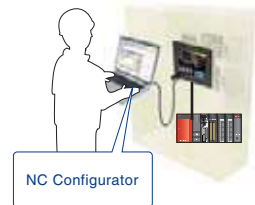

Ideal for CNC programming!

Can CNC programs be validated directly from the GOT?



Ladder monitor function

For details, see P.44

CNC C70 sequence programs can be monitored in a circuit diagram (ladder format).

Can the root cause be easily identified?



One-touch ladder jump function

For details, see P.44

By setting a program name and coil number of the CNC C70 to a touch switch, the relevant ladder circuit block can be displayed directly. Problems can be handled smoothly from the alarm screen.

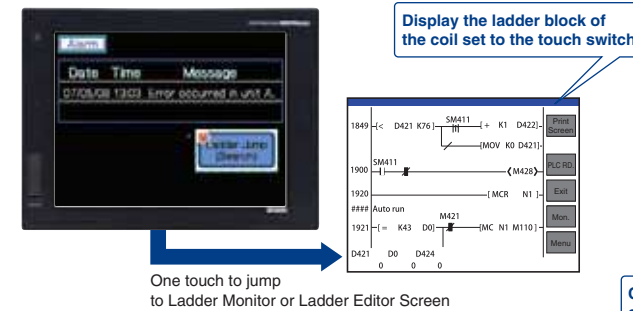

Can programs be changed easily without a personal computer?



Ladder editor function

For details, see P.45

Sequence programs of the CNC C70 can be edited in a circuit diagram (ladder format).

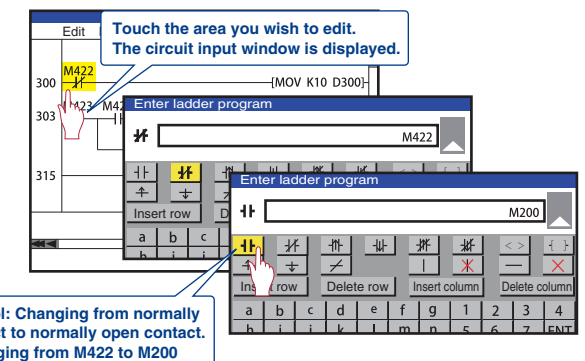

In the event of trouble!

Can the CNC programs be recovered after failure?



Backup/restoration function

For details, see P.42

CNC C70 data such as machining programs and parameters can be backed up to the memory card or USB memory in the GOT. Users can perform batch operation to restore the data to the CNC C70.

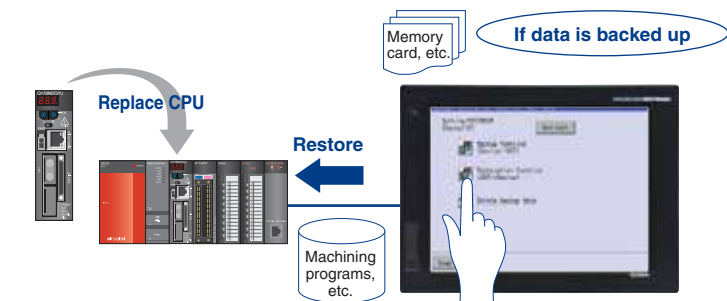

FA Solutions

Improving vision integration.



Ideal for configuration!

Can vision parameters be changed from the GOT?

Ready-to-use sample screens

Sample screen data is available for checking the results of positioning, inspection, and reading characters.

[Alignment screen]

The workpiece position and posture detected with In-Sight Series as well as the success or failure state of the detection are displayed. The workpiece detection threshold can be changed from this screen.



[Inspection screen]

The results of workpiece inspections carried out with the In-Sight Series are displayed. The workpiece detection threshold can be changed.



[Code recognition screen]

The results of reading ID codes with the In-Sight Series are displayed. The reading mode (read/verify or change character string during verification) can be selected.



Powerful functions for vision systems!

Can automation and vision systems be consolidated into a single platform?

Displaying the In-Sight Series processing results on the GOT

By connecting a GOT to the In-Sight Series and PLC over Ethernet, the In-Sight Series processing results can be displayed and parameters can be changed on the GOT. The GT16 model has a built-in Ethernet port, allowing the system to be built easily.

Ideal for monitoring operations!

Can vision applications be handled easily at the worksite?

Displaying In-Sight Series vision applications on the GOT

Connect the COGNEX VisionView VGA with the GOT to display the In-Sight Series Vision Application screen. While monitoring connected devices such as PLCs, it is possible to switch to the Vision Application screen when necessary to display live images, specify parameters with touch operations, and perform other operations.

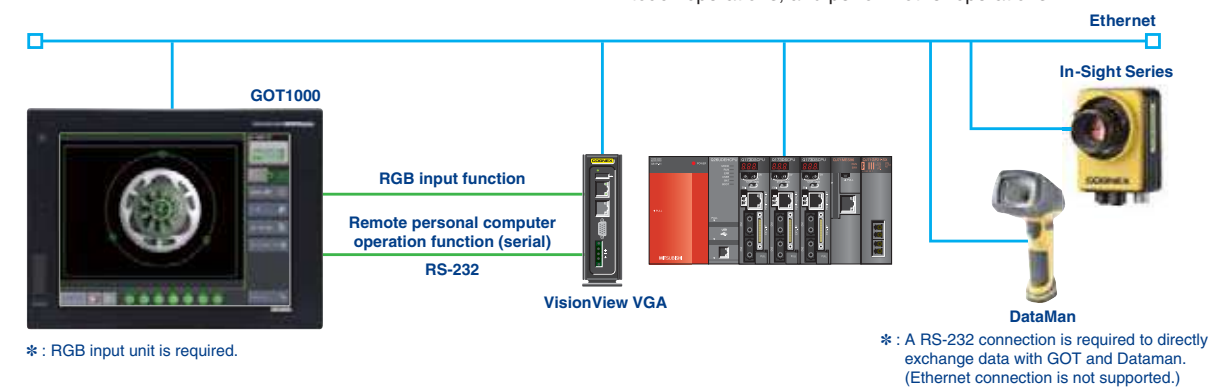
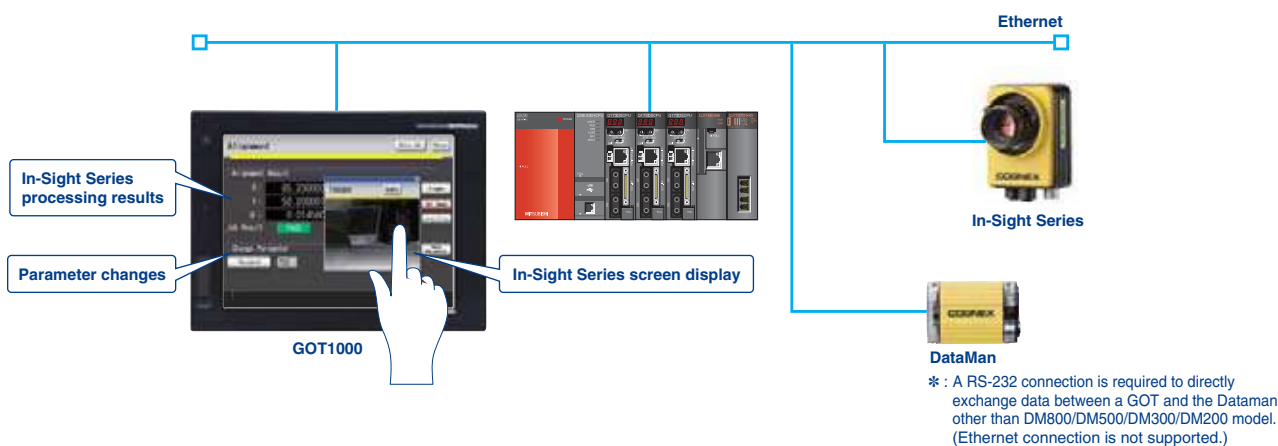

Can other COGNEX products be connected?

Connect to various COGNEX products

The In-Sight vision system and DataMan barcode reader can be connected to the GOT.

Ideal for switching jobs!

Can jobs be switched easily at the worksite?

Managing In-Sight Series job files with the GOT

Jobs can be switched easily by storing the In-Sight Series job files in the GOT's memory card or USB memory, and then restoring and loading them into the In-Sight Series when needed. Various files in the In-Sight Series, including job files, can be backed up in the GOT.

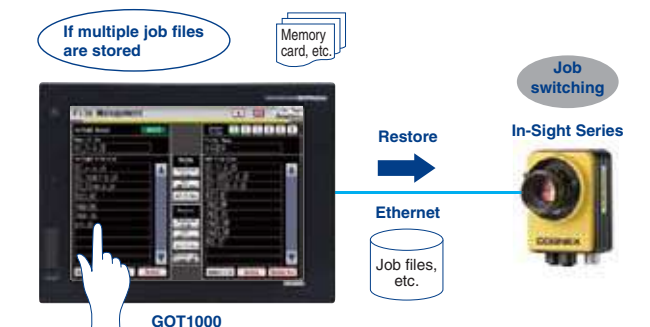

The lineup that fits in with any production line. Find your GOT with the right functions, size, and features.

GT16

High performance models with multimedia and a host of features and functions including embedded communications

* See page 25 for GT16 Handy.

- User memory capacity: 15MB (GT16□□-VNB□ : 11MB)
- USB host and USB device ports are included.
- Ethernet, RS-422/485, and RS-232 interfaces are supported as standard interfaces.
- A multimedia unit and a video/RGB unit are supported.*
- Featuring an analog touch panel

* : Excluding GT16□□-VNB□, GT1655

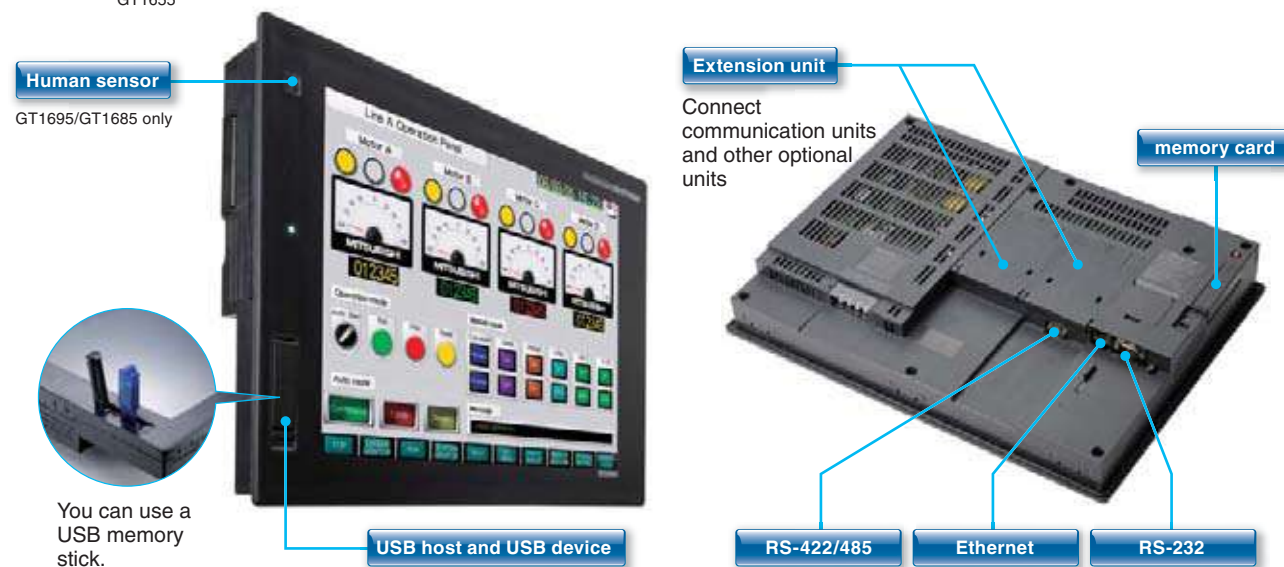
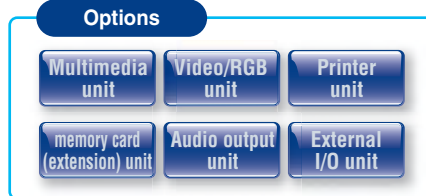

GT14

Standard model with advanced features and communication interfaces

- User memory capacity: 9MB
- USB host and USB device ports are included.
- Ethernet, RS-422/485, and RS-232 interfaces are supported as standard interfaces.
- SD card interface is supported as a standard interface.

Convenient options increase flexibility

Panel-mounted USB port extension
GT14-C10EXUSB-4S
Bring the rear USB port to the front surface of the control panel.



RS-232/485 signal conversion adapter
GT14-RS2T4-9P
Convert the GOT's RS-232 port into a RS-485 port.



GT15

Performance models ideal for a wide range of applications in a network or standalone environment

- User memory capacity: 9MB (GT15□□-VNB□: 5MB)
- USB device port is included.
- The RS-232 interface is supported as a standard interface.
- A video/RGB unit is supported.*

* : GT1585V/GT1575V only

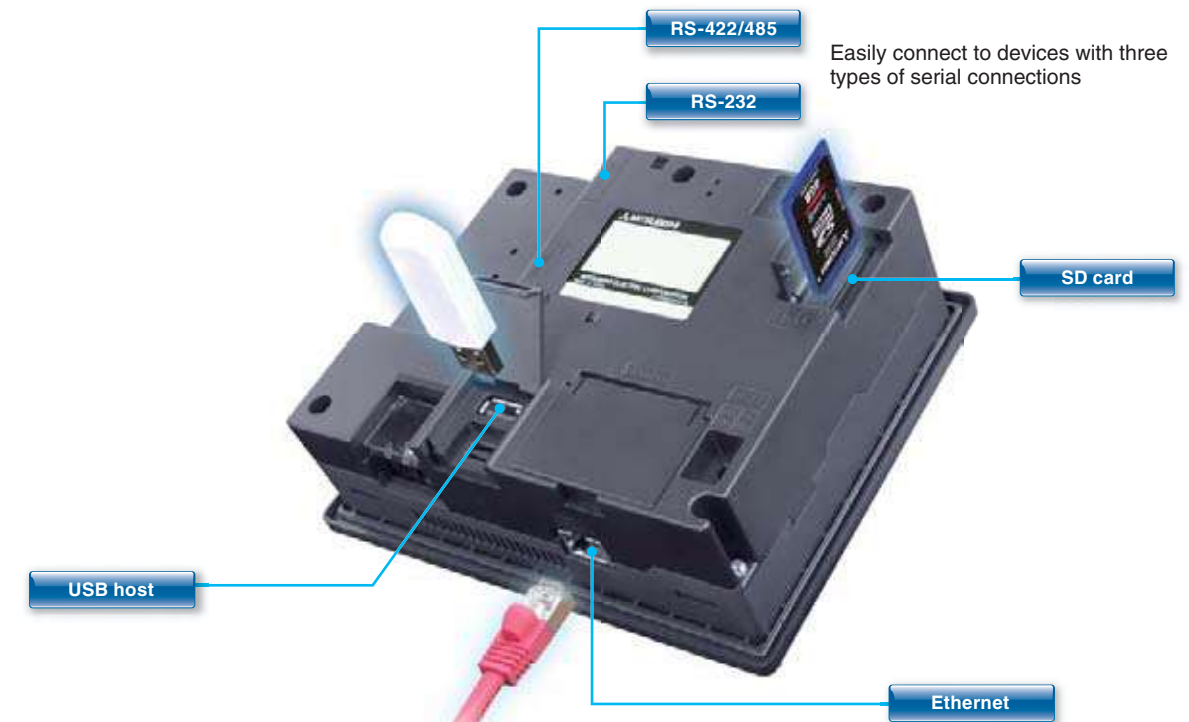
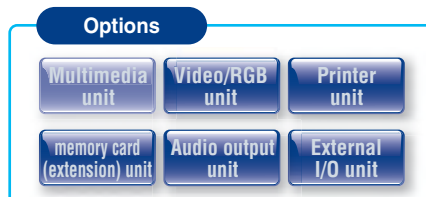

GOT, available in a variety of compact bodies, is packed with GOT1000 functions.

GT12

Large basic models with integrated features and communication interfaces

- User memory capacity: 6MB
- USB device port is included.
- Ethernet, RS-422/485, and RS-232 interfaces are supported as standard interfaces.
- Featuring an analog touch panel

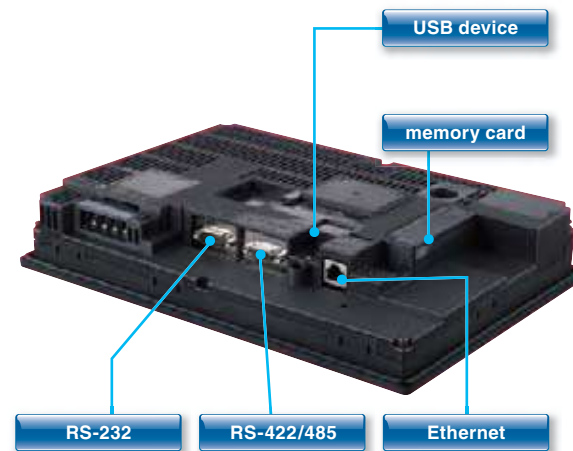

GT10

Compact models with basic functions

GT1030/GT1020

- User memory capacity: 1.5MB (GT1030)/ 512KB (GT1020)
- Three-color LED backlight indicates the equipment status at a glance.
- The RS-422/485* interface or the RS-232 interface is supported as a standard interface.

* : Only the RS-422 interface for the 5VDC type

* : For details about the functions of GT10 models, see "GT10 (pages 48, 49)".

GT1055/GT1050/GT1045/GT1040

- User memory capacity: 3MB
- USB device port is included.
- RS-422/485 and RS-232 interfaces are supported as standard interfaces.

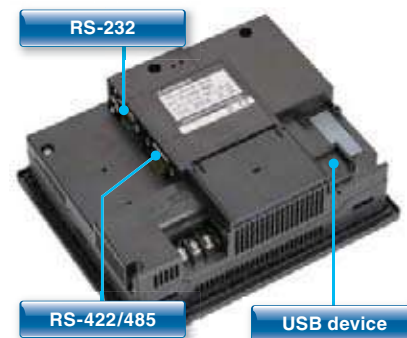

Rich functionality and high performance in the palm of your hand

GT16 Handy GOT

The light body includes the latest GT16 functions

6.5" High resolution handy GOT
GT1665HS-VTBD

Options

- Emergency stop switch guard cover
- External connection cable

Ergonomic design allows you to change the angle of the handle.



Various types of switches are available

- Operation switches with LEDs (6)
- Emergency stop switch
- Selector switch with key
- Three-position deadman switch

Various types of external connection interfaces are available as standard interfaces

- USB host and USB device
- CF card interface
- RS-422/485 and RS-232 interfaces (switchable)*1
- Ethernet interface*1

*1 : Connector conversion box is required.

- User memory capacity: 15MB
- USB host and USB device ports are included.
- Ethernet, RS-422/485, and RS-232 interfaces are supported as standard interfaces.
- The latest GT16 functions are available, including various types of monitoring functions.
- Display a vibrant 65,536 colors on the 6.5-inch VGA screen!



An example of a system configuration with Ethernet connection

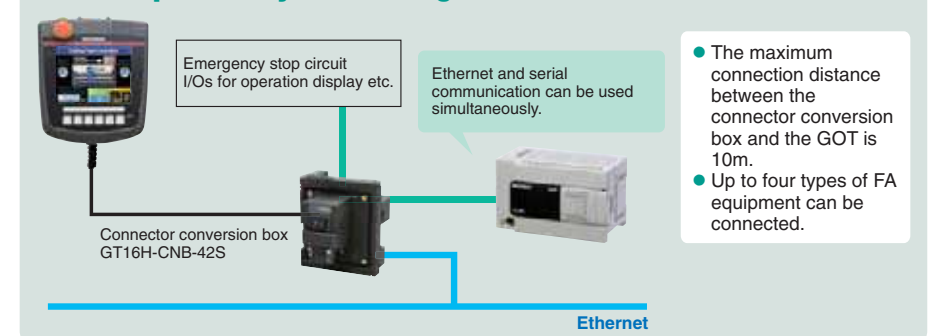

GT11 Handy GOT

Portable 5.7" operation terminal

GT1155HS-QSBD
GT1150HS-QLBD

GT11 Handy can be connected to the CC-Link network.

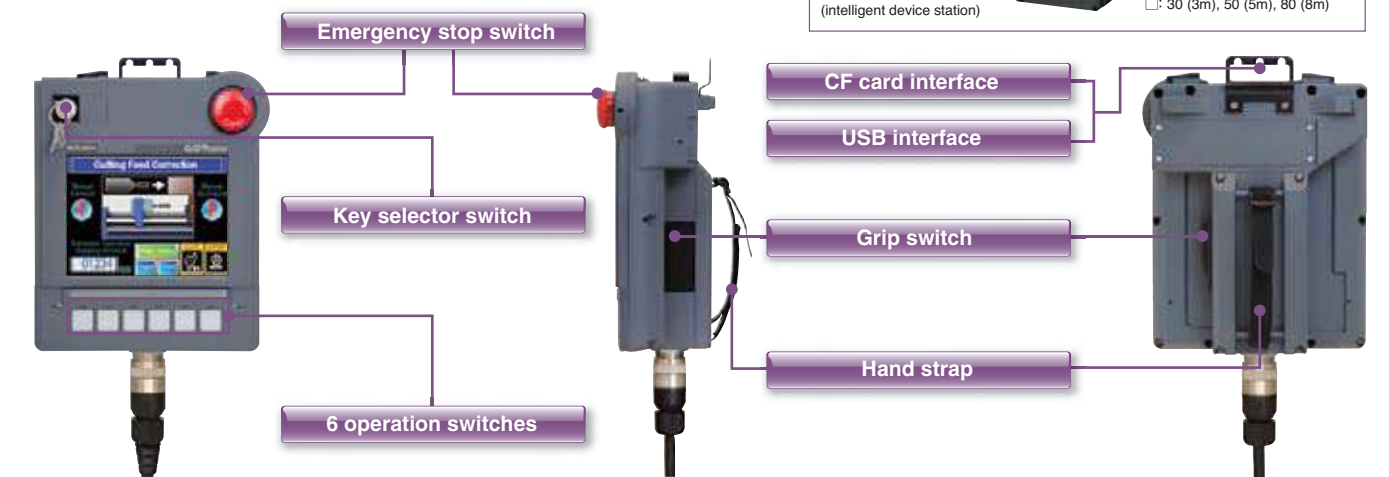
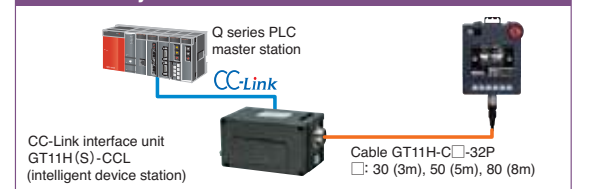

Use a personal computer or panel computer as a GOT.

HMI software for the GOT1000 series

MELSOFT **GT SoftGOT1000** Version3

GT SoftGOT1000

GT SoftGOT1000 is the HMI software that provides GOT functions on personal computers and panel computers.

This software connects with various types of equipment such as Mitsubishi PLCs and let you see screens just like the GOT1000 series.

You can also reuse GOT's project data without modification.

Along with all the advantages of a GOT, you can also enjoy the convenience and flexibility of personal computers and panel computers.



GT SoftGOT1000 Version3 is software included with the GT Works3 suite. A separate license key is required for use.

Monitor the production site from a remote location

Reduce downtime

Use GT SoftGOT1000 to monitor the production site from your office. You can collect information quickly when a problem occurs, taking necessary actions immediately.

Use GOT project data from the production site

You can reuse project data of the GOT at your production site as the project data of GT SoftGOT1000 to reduce the design cost.

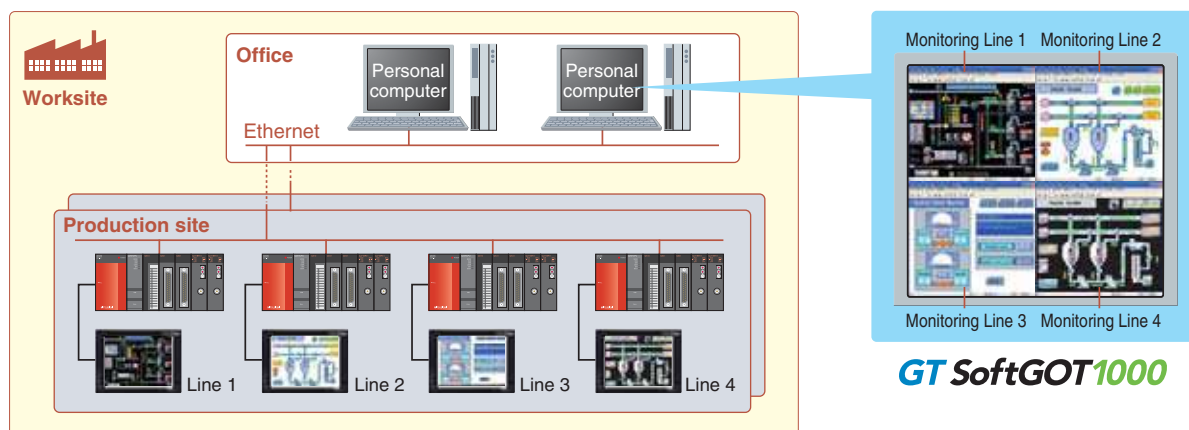

Connect with MELSEC process control for process control applications

You can connect GT SoftGOT1000 to the monitor tools of the Engineering Environment PX Developer for design and maintenance work for process control. In this way, a process control monitoring system can easily be constructed.

PX Developer window screens and other tools

Tools for monitoring, operating, and tuning loop control tags. (The display position can be specified.)

GT SoftGOT1000 touch switch/object

Clicking on touch switches and objects displays various screens of PX Developer monitoring tools. (The display position can be specified.)

Security collaboration

The GT SoftGOT1000 security level is changed accordingly when the PX Developer monitor tool's mode is changed (engineer mode/operate mode/lock mode). Authority can be set for operations requiring security.

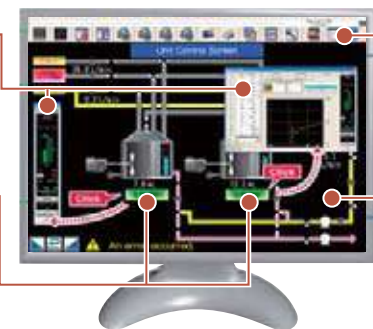

PX Developer monitoring tool bar

Clicking on buttons executes various operations such as starting up GT SoftGOT1000 and switching base screens.

GT SoftGOT1000 base screen

Make your desktop into a graphic monitoring window by displaying the GT SoftGOT1000 base screen in full-screen mode and sending the window to the back of the screen.

Link with other applications to construct a high-performance system

You can use a user-created application to read and write information to and from internal devices of GT SoftGOT1000. By linking data with user applications such as a data logger, you can construct a high-performance system package. You can also use a touch switch on the GT SoftGOT1000 monitor to launch another application.

<Development environment of user applications>

- Microsoft® Visual C++®/Visual C#®/Visual Basic® included with Microsoft® Visual Studio 6.0/.NET (2002)/.NET 2003/2005/2008
- Embarcadero® C++Builder® XE

Connect to various devices

The GT SoftGOT1000 can be connected to the Mitsubishi PLC, other PLC brands, MODBUS®/TCP slave devices.

*: See "List of connectable models" (page 69), for more details on supported models of other manufacturers.

Connect to RFID or barcode reader and input numerical values or ASCII characters.

The SoftGOT-GOT link function enhances the linkage to your onsite GOT

Monitor the screen of your onsite GOT from GT SoftGOT1000

Connect GT SoftGOT1000 with GOT by an Ethernet connection. Use the GOT's project data with GT SoftGOT1000 to monitor connected equipment.*

*: Only CH1 can be monitored when GOT is connected via multi-channels. GOT and QCPU/LCPU can be connected by a bus connection, direct CPU connection, computer link connection, or Ethernet connection. GOT and OMRON PLC can be connected via Ethernet connection.

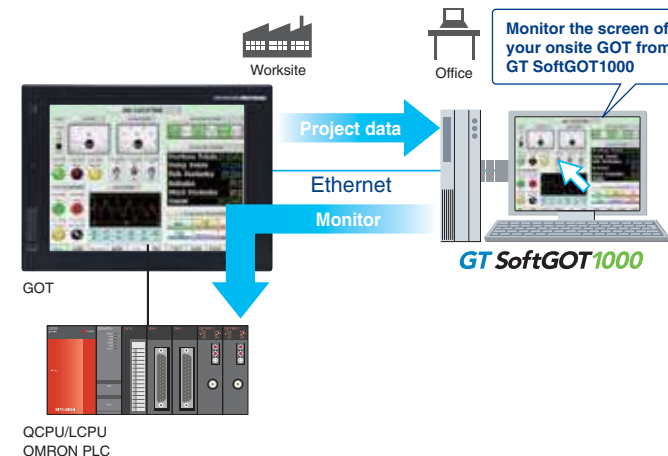

Prevent simultaneous operations from GT SoftGOT1000 and GOT

Operation of an input object (e.g. touch switch, numerical input) is allowed by either GT SoftGOT1000 or the GOT, whichever has operating authority. If one terminal does not have operating authority, the status of the operating authority can be displayed in a pop-up window. Whether it is possible to acquire operating authority from the other terminal can be notified with a dialog. It is also possible to specify the time to ensure the operating authority on the operation side after final operations.

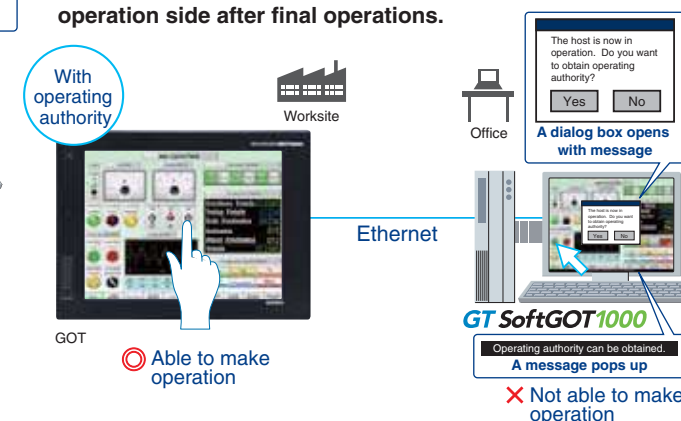

GT SoftGOT1000 Commander

By using the GT SoftGOT1000 Commander, multiple GT SoftGOT1000 modules using the SoftGOT-GOT link function can be efficiently managed, and the SoftGOT-GOT link function can be utilized easily.

<Actions possible with GT SoftGOT1000 Commander>

- Search for GOT on the Ethernet network and start with GT SoftGOT1000 (GT16 only) (It is also possible to select which GOTs are displayed in the Search List.) **NEW**
- Start/stop GT SoftGOT1000
- Check and switch GT SoftGOT1000 monitor status (online/offline)
- Designate GT SoftGOT1000 module No. displayed on top screen

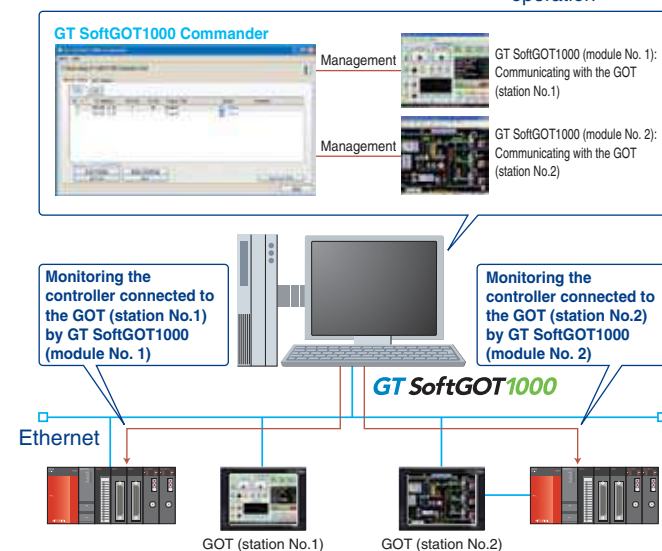

See "List of connectable models" (page 69), "Function list" (page 70), and "Notes for use (Operating environment)" (page 86).

More intuitive. No more wasted time. The screen

design software optimized for usability.

GOT1000 Screen Design Software
MELSOFT GT Works3

Enhanced "easy-to-use" functions for efficient screen design!

For more details, see the GT Works3 catalog (L (NA) 08170).

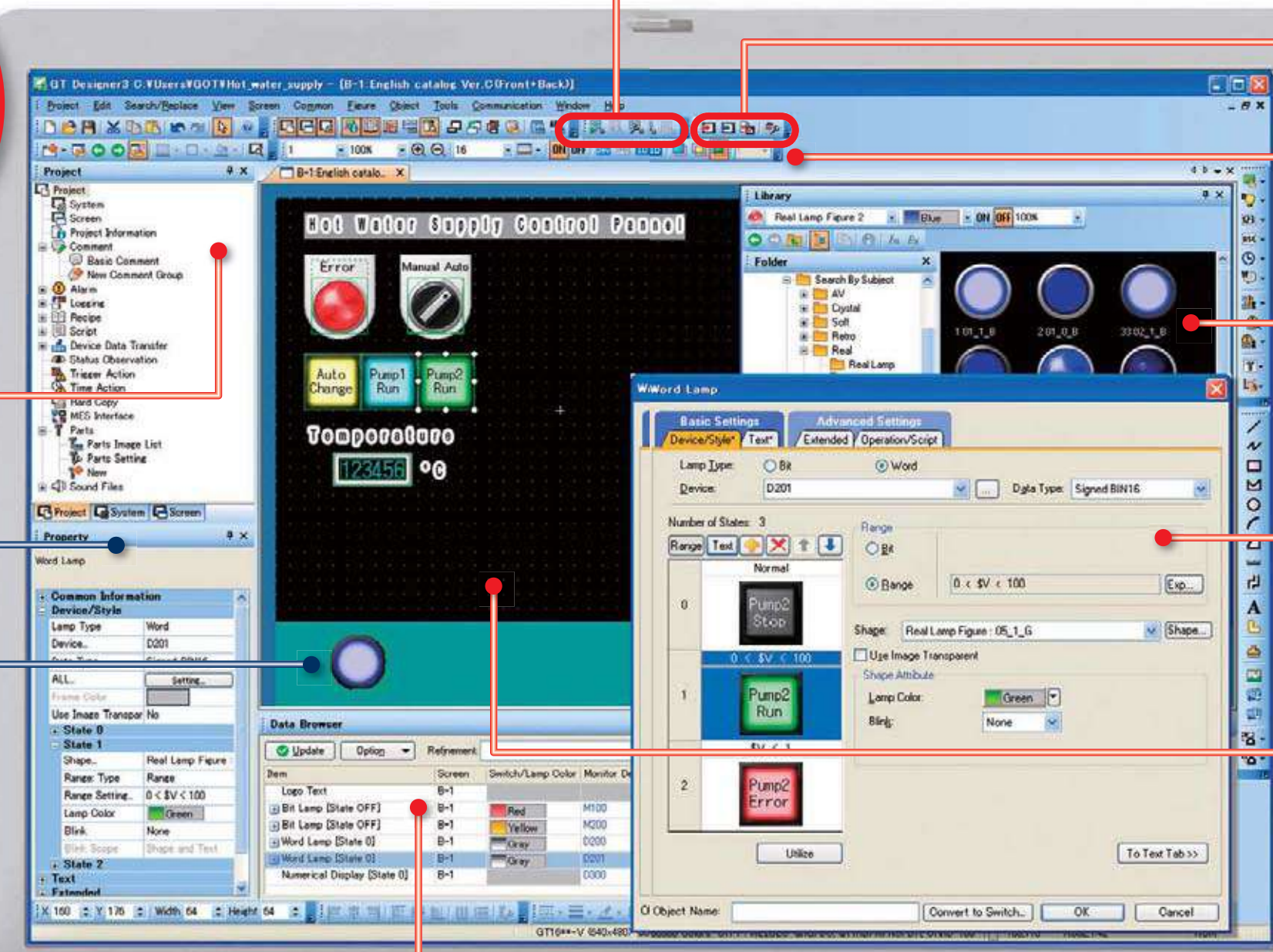
Work Tree
View the whole project, create a new screen, and add and delete screens with ease.

Property Sheet
A selected object or graphic's settings are displayed as a tree view. Set colors, devices, etc., on the property sheet without opening a dialog box. When selecting multiple objects or graphics, change color, character size, etc., all at the same time.

Temporary Area
Reduce workspace clutter by moving objects off of the display area.

MELSOFT iQ Works Improves Design Efficiency
Batch parameter check and system labels of MELSOFT Navigator are supported.

Data Browser
The object settings are listed allowing settings to be confirmed and revised easily!

Related Tools
GT Works3 comes with various tools such as the Data Transfer Tool and GT Converter2.

Simulator
Preview operation without connecting to a GOT.

Communication with GOT
Communication settings and drivers are automatically selected and downloaded to the GOT with the project data.

Tool Bar
Vividly colored icons make distinguishing active functions from inactive ones easy.

Library
Parts are easy to select. High resolution graphics and parts are easy create and incorporate into projects.

Dialog Box
User-friendly dialog boxes and object settings.

Editor <Screen Design Area>
Many convenient and efficient development functions are included!
New functions improve your screen design efficiency than ever before!

- Use "templates" to greatly reduce your screen creation time!
- Make batch changes with a single right-click!
- Register parts with a single right-click!
- Easily create addition and subtraction word switches!

User (OEM/End User) Security Function!

The Help Function is available for quick reference!

The GOT1000 series provides a variety of functions to satisfy user requirements

Usability depends on who the users are and where they carry out their tasks.

Designers want to use the most advanced HMI technology, while maintenance engineers want the most dependable HMI for their facilities.

To satisfy all of our customers, we are constantly developing more and more functions for the GOT1000 series.

INDEX

GT16/GT15/GT14/GT12/GT11 Functions	32
For Designers	32
For Initial Startup & Adjustment Operators	38
For Maintenance Personnel	40
GT10 Functions	48
iQ Platform	50
MELSEC Process Control	51
Specifications	52
External Dimensions	61
List of Connectable Models	65
Function List	70
Product List	74
Notes for Use	81
Warranty	87

There are many different applications to be solved. How do we stay flexible?

For designers

Multimedia function	32
Video/RGB function	32
Document display function	33
Multi-channel function	33
VNC® server function	34
Remote personal computer operation function (Ethernet)	34
SoftGOT-GOT link function	34
Remote personal computer operation function (Serial)	34
File transfer function (FTP client)	34
FTP server function	34
USB mouse/keyboard connection	34
Gateway function	35
MES interface function	35
Comment groups	36
Multilingual support	36
Advanced recipe function	37
Script function	37
Various types of window screens	37

Efficiency requires both fast data transfer as well as user-friendly functions.

For initial startup & operations

Drawing, computing, communication; a trio of high-speed response functions	38
Backlight brightness adjustment	38
Color-coded front face LED	38
Maintenance time notification function	38
Equipped with front USB interface	39
FA transparent function	39

To restore a system as quickly as possible, response capabilities for "just in case" situations are the key to selecting a HMI display.

For maintenance personnel

Logging function/historical trend graph/historical data list display	40
Log viewer function	40
Operator authentication function	41
Operation log function	41
Backup/restoration function	42
Advanced alarm	43
Ladder monitor function	44
SFC monitor function	44
Ladder editor function	45
Motion SFC monitor function	45
System monitor function	46
Network monitor function	46
Intelligent module monitor function	46
MELSEC-L troubleshooting function	46
Q series motion monitor function	47
Servo amplifier monitor function	47
CNC monitor function/CNC data I/O function	47
List editor for A/List editor for FX	47



The functions bearing these marks are available on the GT16, GT15, GT14, or GT12 model. All other functions are supported by GT16, GT15, GT14, GT12, and GT11 models.

*: For details about the functions of GT10 models, see "GT10 (pages 48, 49)".

Freedom to utilize advanced display functions to enhance the GOT

For designers

Smooth, high-quality motion images help efficiently investigate the cause of a problem

GRAPHIC OPERATION TERMINAL GOT 1000

GT 16 Multimedia function

Recording audio and video, displaying input images

Clear view before and after the trouble occurrence
<Recording pre/post event motion images>

- Capable of recording motion images for 120 seconds before and after an error occurrence (when the event trigger device turned on), up to 240 seconds in total.

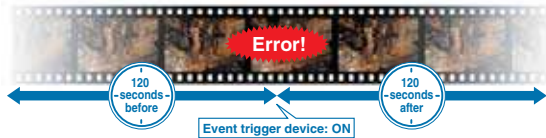

High resolution recorded image (standard mode)

- Smooth, high resolution video can be recorded.
- Video size and frame rate
 - Maximum 15 fps in VGA (640 × 480)
 - Maximum 30 fps in QVGA (320 × 240)

Playing back motion image files

Check the motion image before and after the occurrence of a problem, and diagnose the cause immediately.

- The motion image recorded on site is saved in the memory card of the GOT's multimedia unit and can be played back immediately after being recorded.
- The motion image files saved in a memory card can be played back by selecting the file name or record date **NEW** with a touch switch or in the multimedia screen on the GOT main unit.
- The files can be sent to your personal computer over the Ethernet interface of the GOT's multimedia unit and can be viewed on the computer.
- Fast forward and slow motion playback functions are also available.

Use as a video guidebook for work tasks

- The GOT plays back motion image files that are created by your personal computer. Since the GOT is compatible with standard formats, commercially available software can be used to create motion image files.

<Applicable software programs> • Quick Time 7 Pro
<Compatible file formats> • 3GP and MP4

High-quality images with 65,536 colors provide precise detail

GRAPHIC OPERATION TERMINAL GOT 1000

GT 16 GT 15 Video/RGB function

Enhanced compatibility with cameras and inspection devices <Video input>

- Input images from up to four video cameras and inspection devices are simultaneously and cleanly displayed in four windows in 65,536 colors. Images can be saved in JPEG format.

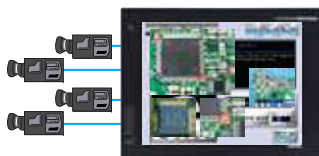

For additional recording time (extended mode)

- Over two days of video can be recorded.
- Video size QVGA (320 × 240); frame rate 15 fps
- Possible to either delete saved motion image files or save them when starting a new recording. **NEW**

Displaying input images

- In addition to the dedicated screen, images input from a video camera can be displayed on a user-created screen. Normally, input images are displayed on the user-created screen, and the dedicated multi-media screen is opened only when an error occurs or when playing back recorded images for confirmation.

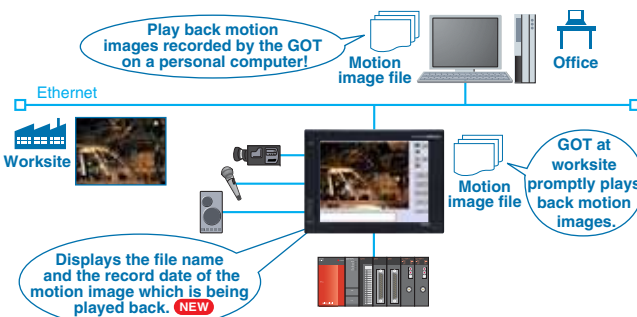

The dedicated multimedia screen is available for recording and playback. Reduce your screen design time!

- * : Not supported by GT16□□-VN□□, GT1655, GT16 Handy.
- * : The multimedia data link tool and multimedia data link FTP services are necessary to transmit motion image files to a personal computer.
- * : Only one of the following devices can be used at one time: multimedia unit, video input unit, RGB input unit, video/RGB input unit or RGB input unit.

The multimedia interaction tool and multimedia interaction FTP service are multimedia-dedicated software programs included with GT Works3.

An optional device may be necessary. For details, see "Selection of optional units and devices" (page 81).

Displays PC images on the GOT <RGB input>

- Images on a personal computer display screen appear on the GOT simultaneously with the GOT's screen. RGB input of up to 2 channels is available when using the GT16M-R2.
- The display size can be changed, and the clip display is available. (For GT16 only)

Display the GOT screen on a display <RGB output>

- Connect to a commercial display so that the GOT screen can be displayed larger.
- * : Not supported by GT16□□-VN□□, GT1655, GT16 Handy.
- * : Only one of the following devices can be used on the GT16 at one time; video input unit, RGB input unit, video/RGB input unit, RGB output unit, or multimedia unit.
- * : Only the GT1585V and GT1575V for the GT15 series. Only one of the following devices can be used at one time; video input unit, RGB input unit, video/RGB input unit, or RGB output unit.

An optional device may be necessary. For details, see "Selection of optional units and devices" (page 81).

Display various documents on the GOT at the worksite

GRAPHIC OPERATION TERMINAL GOT 1000

GT 16 GT 15 Document display function

- When a system error occurs, referring to recovery methods in check lists and/or manuals on the GOT can reduce downtime.

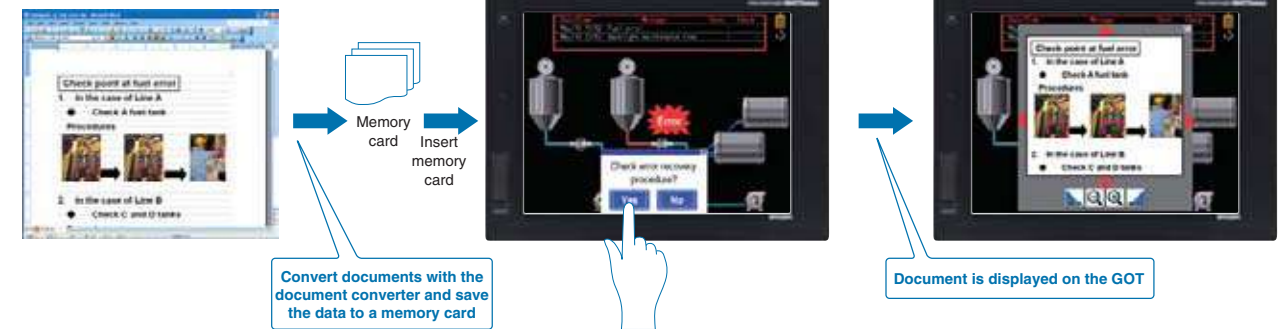

Display of documents and manuals on the GOT can reduce downtime.

An optional device may be necessary. For details, see "Selection of optional units and devices" (page 81).

Central storage of FA device information on a single GOT terminal

GRAPHIC OPERATION TERMINAL GOT 1000

GT 16 GT 15 GT 14 GT 12 Multi-channel function

- Up to four FA device (PLC, servo, inverter, temperature controller, etc.) channels* can be monitored with one GOT unit.
- * : GT155□, GT14, and GT12 monitor up to two channels.
- Easy device transfer between connected devices. Use GT Works3 to specify triggers for source and destination devices for device transfer. (Device data transfer function)

For various types of peripherals.

- General-purpose MODBUS® devices
- External devices (operation panels, switches, lamps, etc.)
- Two-dimensional code readers, barcode readers
- RFID readers, IC card readers
- Speakers
- Video cameras
- Displays (RGB output)
- PCs (RGB input)
- Serial printers
- PictBridge printers
- Vision sensors*

* : For details, see "CASE STUDY 2 (FA Solutions)" (page 20).

Typical applications

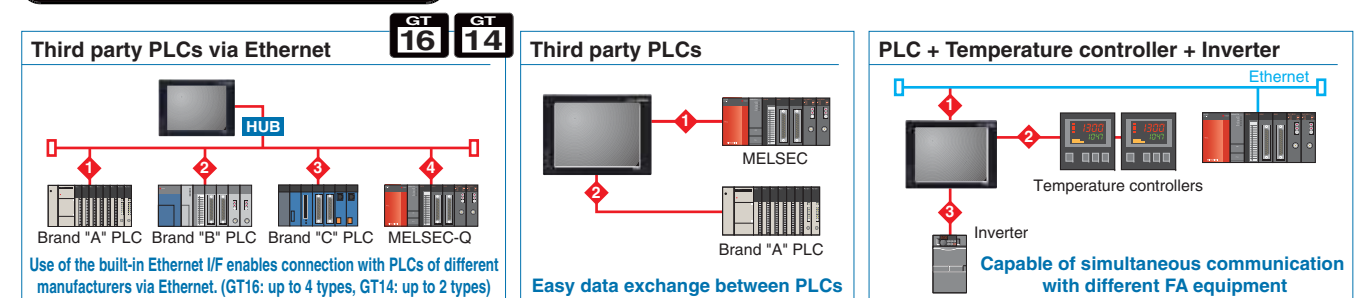

Use of the built-in Ethernet I/F enables connection with PLCs of different manufacturers via Ethernet. (GT16: up to 4 types, GT14: up to 2 types)

- * : For the Ethernet connection with GT1695 and GT1685 of function version A, if connected to equipment compatible with 10BASE-T, use a switching hub for its operation in a network environment where both 10Mbps and 100Mbps systems are operable.
- * : The number of channels and functions, which can be used with the multi-channel function vary depending on the connection configuration. For more details, see "Notes for use" (page 81 to page 86).

An optional device may be necessary. For details, see "Selection of optional units and devices" (page 81).

INDEX

For Designers

For Initial Startup & Operations

For Maintenance Personnel

GT10

IQ Platform

MELSEC Process Control

Specifications, External Dimensions

List of Connectable Models, etc.

Operate the GOT at a remote location from a personal computer in your office

GT 16 VNC® server function

- The screens of a GOT at a remote location can be viewed and operated from a personal computer in your office.
- Operating authority control prevents problems that may occur during simultaneous operations from a GOT at a worksite and a personal computer in a remote location. Available password setting allows control of who can view and operate the GOT.

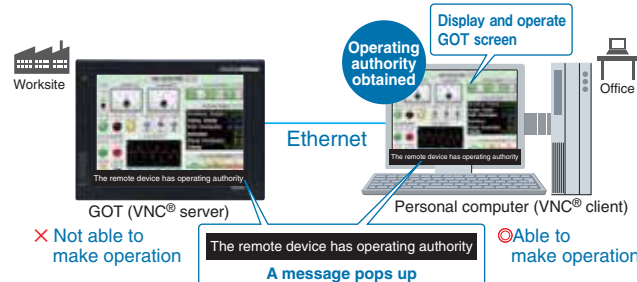

<Applicable VNC® Client Software>
 ● Software name: Ultra VNC version 1.0.8.2 is recommended.
 ● Manufacture name: UltraVNC team
 * : A license key (GT16-VNCSKEY) is required.

Monitor the screen of the onsite GOT from your PC screen

GT 16 GT 15 SoftGOT-GOT link function

- Connect GT SoftGOT1000 with the GOT with an Ethernet connection. Use the GOT's project data with GT SoftGOT1000 to monitor connected equipment.*
- Operation of an input object (e.g. touch switch, numerical input) is allowed by either the GT SoftGOT1000 or GOT, depending on which has operating authority.
- By using the GT SoftGOT1000 Commander, multiple GT SoftGOT1000 modules using the SoftGOT-GOT link function can be efficiently managed, and the SoftGOT-GOT link function can be utilized easily.

* : Only CH1 can be monitored when GOT is connected via multi-channels. GOT and QCPU/LCPU can be connected by a bus connection, direct CPU connection, computer link connection, or Ethernet connection. GOT and OMRON PLC can be connected via Ethernet connection.

See "GT SoftGOT1000" (page 27), for more details.

Files can be sent and received between a GOT and a personal computer

GT 16 GT 15 GT 14 File transfer function (FTP client)

- By using a GOT, files (alarm log files, hard copies, etc.) stored in the GOT's memory card and USB memory can be sent to or from a personal computer.
- File names and folder names can be specified indirectly.

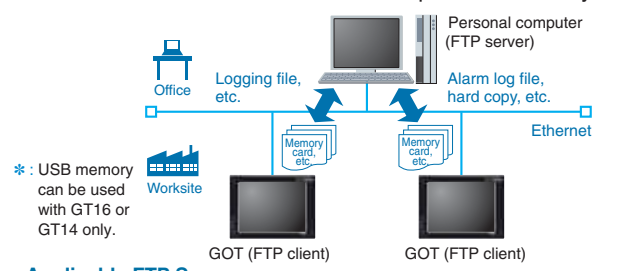

<Applicable FTP Servers>
 ● GOT (FTP Server Function) ● Web Server Unit (QJ71WS96)
 ● Windows® Server 2003 FTP Service (included with IIS)
 ● Cognex Vision Sensor (In-Sight Series)

An optional device may be necessary. For details, see "Selection of optional units and devices" (page 81).

Operate a remote PC from an onsite GOT

GT 16 Remote personal computer operation function (Ethernet) (VNC® client function)

- A personal computer at a remote location can be operated from an onsite GOT when they are connected via Ethernet.
- A USB mouse/keyboard can be connected to the front USB interface.



* : Not supported by GT16□□-VN□□, GT16 Handy
 * : The license key (GT16-PCRAKEY) is necessary.

Operate a personal computer from the GOT touch screen

GT 16 GT 15 Remote personal computer operation function (Serial)

- When using RGB input, operate a personal computer screen displayed on the GOT by touch operation (e.g. store information such as touched coordinates in GOT internal devices, transmit the data to a personal computer).

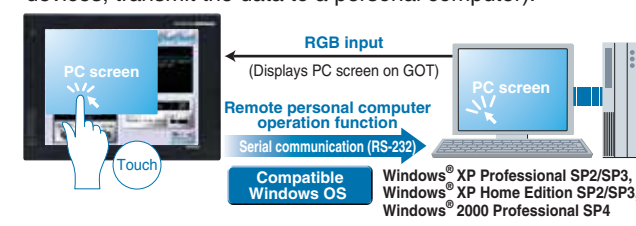

* : Not supported by GT16□□-VN□□, GT1655, GT16 Handy
 * : Supported only on the GT1585V and GT1575V models in the GT15 series.

An optional device may be necessary. For details, see "Selection of optional units and devices" (page 81).

Files can be sent and received between a personal computer and a GOT

GT 16 GT 15 GT 14 GT 12 FTP server function

- By using a personal computer, files (alarm log files, hard copies, etc.) stored in a GOT's memory card and USB memory **NEW** can be sent to or from the GOT.

* : USB memory can be used with GT16 or GT14 only.
 * : This function is a part of the Gateway function. For how to select optional devices, see the section about the Gateway function.

Connect your mouse/keyboard to the front USB interface

GT 16 GT 14 USB mouse/keyboard connection

- In a user-created screen, you can use your mouse to click touch switches and your keyboard to enter ASCII characters and numbers.

* : Not supported by GT16 Handy
 This is convenient when you need to operate small switches or enter many characters.

Be alerted about worksite errors and collect device data from the office

GT 16 GT 15 GT 14 GT 12 Gateway function

*1 : GT12 supports only the FTP server function.

The gateway function remotely monitors the worksite and supports remote maintenance from the office.

1 Collect data on a personal computer (server function)

- A GOT (server) can be monitored from the host personal computer (MX Component) to perform indirect reading/writing of connected devices being monitored by the GOT.
- Even when third party devices are connected, MX Component can read and write the devices through the GOT using the server function.

* : The collected data can be displayed and analyzed by Excel® without using any programs other than MX Sheet. Programming with Visual C++® and Visual Basic® enables applications to be flexibly designed and built. See the MELSOFT catalog (L (NA) 08008) for more details.

2 Monitor other GOTs from a GOT (client function)

- A GOT (client) indirectly reads/writes device values of equipment monitored by another GOT (server).
- The client function can also be used to indirectly read/write device values of PLC CPUs other than the one to which the GOT (client) is connected.

Database linkage support enhances productivity at your worksite

GT 16 GT 15 MES interface function

The GOT transmits data from connected FA devices to the server personal computer database via SQL statements.

- For communication with the database, just specify the necessary data in GT Works3 without programming. There is no need to use a gateway personal computer and complicated programs to communicate with the MES database server.

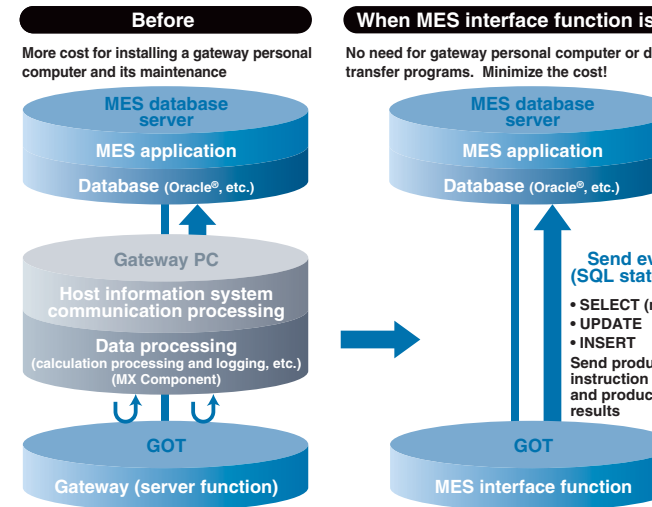

An optional device may be necessary. For details, see "Selection of optional units and devices" (page 81).

3 Mail send function

- The alarm history display function can transmit alarm occurrences and recovery information by e-mail to personal computers and mobile phones.
- * : The SMTP server port should be set to 25 (fixed). The SMTP authentication is not supported.

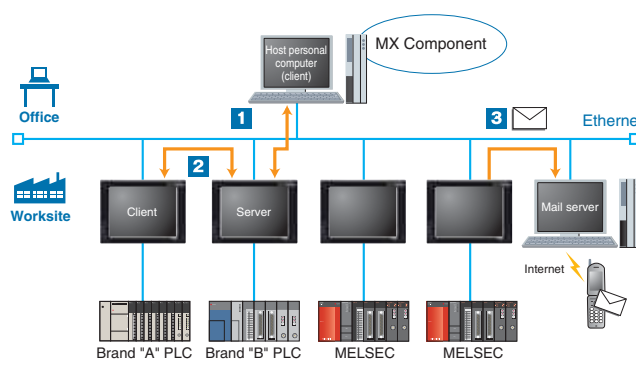

An optional device may be necessary. For details, see "Selection of optional units and devices" (page 81).

MES interface function

- DB link function (tag function / trigger buffering function / trigger monitor function / SQL statement transmission function <SELECT / SELECT multiple data / UPDATE / INSERT> / calculation processing function / program execution function / DB buffering function)
- SNTTP time synchronization function
- Resource data transmission function
- Diagnosis function
- DB server function (ODBC connection function / connection setting function / log output function)

Usable databases

- Oracle® 8i/9i/10g/11g
 - Microsoft® Access® 2000/2003/2007/2010
 - Microsoft® SQL Server® 2000/2005/2008
 - Microsoft® SQL Server® 2000 Desktop Engine (MSDE2000)
 - Wonderware® Historian 9.0
- * : Compatible only with 32-bit versions.

<MES (Manufacturing Execution System)>

A manufacturing execution system (MES) is a system which controls and manages production processes at a worksite in order to optimize quality, productivity, delivery date, and cost.

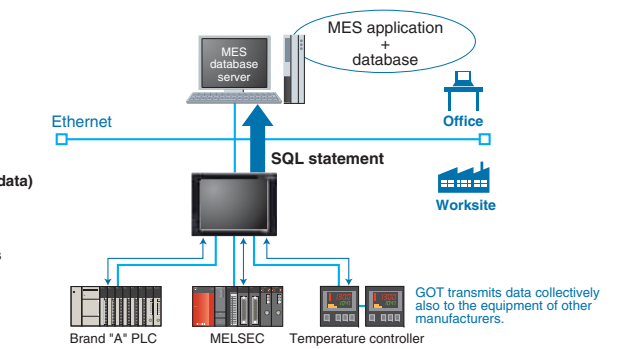

* : Not supported by the GT16 Handy.

Mitsubishi Electric e-Factory presents the appropriate products to connect production information and MES (manufacturing execution system) to improve productivity of clients' plants.

Efficient input of extensive comment data

GRAPHIC OPERATION TERMINAL GOT 1000

Comment groups

- CSV/Unicode text format files can be imported. Multiple files can also be imported to individual comment groups, allowing the task of inputting comments to be distributed among several workers, greatly reducing the required input time.



- Automatically adjusts character size and inserts line feeds according to the object size.

- <Supported objects>
- Touch switches or lamps where "comment group" is selected for labels
 - Comment displays where "comment group" is used



When switching languages, character string length is automatically adjusted to fit within the object.

Easy creation of multilingual screens

GRAPHIC OPERATION TERMINAL GOT 1000

Multilingual support

- By using comment groups, different language comments can be created for each comment group column to switch the display language.
 - Comment group comments can be created freely for applications, as well as for different languages.
 - You can specify the column number of the comment group to change the language of the startup message on the GOT.
- * : Refer to "Comment groups (page 36)" for the details of comment groups.
- The system alarm and utility screen display languages can be changed in conjunction with the language selection function.

Convenient for language switching

When stroke fonts are used with switching languages for touch switches, lamps or comment displays, the character size is automatically adjusted by the size of the object. There is no need to adjust the size of the object when creating a multi-language screen.

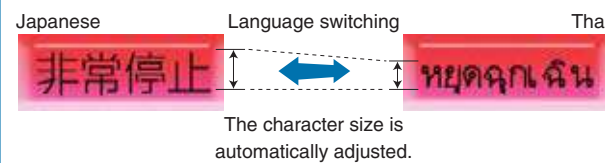

The character size is automatically adjusted.

* : Stroke fonts and Thai characters on GT16 and GT15 only.

Management of project data line by line is no longer required.

Example of comment group use

- 1 Line-specific comment groups are created.



- 2 Import

- 3 Displayed comment group can be switched by a device.

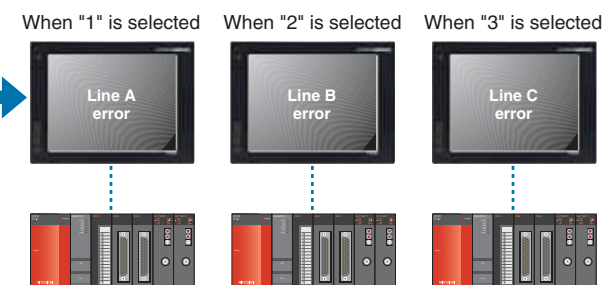

Users can quickly change the language display.

Example of switching between Japanese, English, and Korean screens

- 1 Use comment groups to create Japanese, English and Korean comments in their respective columns.

Column No.			
Comment No.	1	2	3
	1 メニュー	Menu	메뉴
	2 タイミング設定	Timing Setup	시간 설정

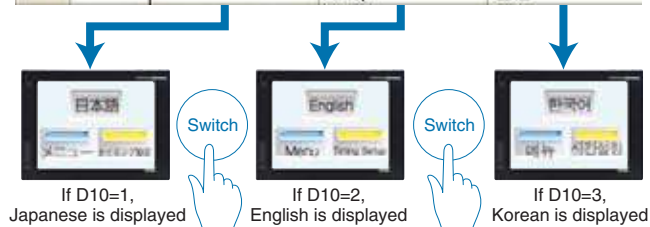

- 2 Set the column number to be displayed in the language switching device.

- 3 The displayed comment (language) changes.

Available for touch switches, lamps, comment displays, the historical data list display, the alarm history function, the user alarm function, and the advanced alarm function.

Easily create complex recipe data

GRAPHIC OPERATION TERMINAL GOT 1000

Advanced recipe function

This function allows material combination data and processing conditions data (device values) to be held in the GOT, with only required data being written to and read from the PLC.

An extensive number of settings and flexible recipe data can be created

- Up to 2,048 blocks can be used, each block is comprised of sequential word devices, an arbitrary word device (1 point), and a bit device (1 point).
- Because devices also permit bit and word combinations and arbitrary device settings, there is no need to centralize the sequential devices used, thereby reducing the total number of device points used.
- Advanced recipe files can be converted into CSV or Unicode format text files, and can be edited on a personal computer. *

* : The advanced recipe file has a binary format. It must therefore be converted to either a CSV file or a Unicode text file by using GT Works3, the GOT utility, or an external control trigger device. After being converted, only the device values can be edited. When more than 251 records are included in an exported Advanced Recipe file (CSV or Unicode text format), use a text editor or Microsoft Excel 2007 or later to open the file.

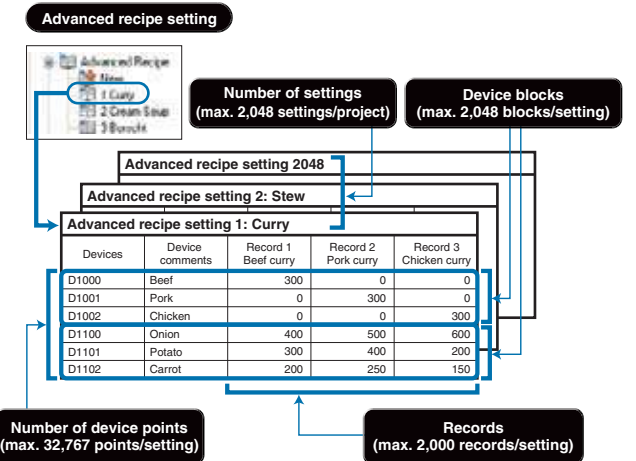

Easy handling of recipe data using the GOT

- Recipes can be handled easily with the GOT's utility function without having to create a recipe operation screen.
- CSV/Unicode text files can be converted into binary format files on the GOT. Even without GT Works3, you can edit data on a personal computer and use it on the GOT.

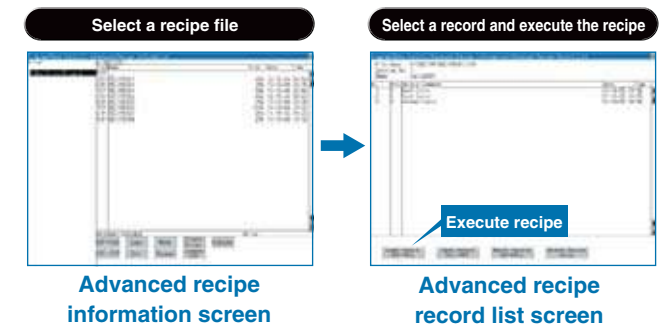

For better work efficiency and enhanced customization functions

GRAPHIC OPERATION TERMINAL GOT 1000

Script function

Project script/screen script

- Control statements, file operation functions, string operation functions, etc. can be specified to a project or to individual screens.

Object script (For GT16/GT15/GT14 only)

- Drawing functions and display control functions can be specified per object. Object functions can be expanded, for example, to change colors and display positions and to freely draw graphics.

Controlling the GOT display with scripts can reduce load on the controller and enhance maintenance performance. The editor includes input support that makes it easy for you to write scripts.

Extreme freedom in designing that enables you to create more effective screens

GRAPHIC OPERATION TERMINAL GOT 1000

Various types of window screens

- Use overlap windows and dialog windows to create various types of screens.

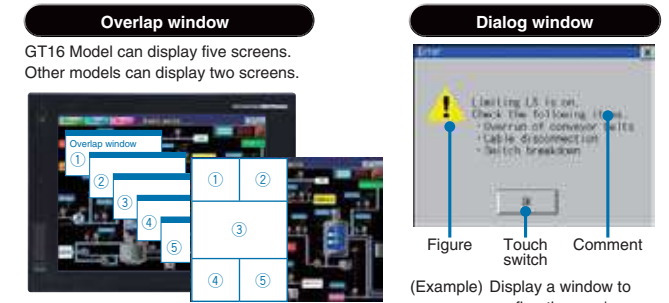

(Example) Hide the title bars to view the screens as divided windows (GT16)

Key window

There is no need to create keypads for numerical input and key windows for ASCII input. When using a QVGA model, the key window screen size can be set from small to large. **NEW** When entering ASCII characters, you can switch windows to display character selection windows.

Standard functions to provide users with straightforward operation

For initial startup & operations

Dramatically improved GOT overall response

GRAPHIC OPERATION TERMINAL GOT 1000

Drawing, computing, communication—a trio of high-speed response functions

The GOT1000 series offers faster response in drawing, computing and communication, reducing monitoring and operation load.

High-speed drawing

- Sharp and quick drawing of complex, layered component screens, and detailed photographic data in 65,536 colors.
- The GT16 further speeds up drawing operations.

High-speed computing

- Ultra-high performance processing power to satisfy the most complex and demanding of applications.

High-speed communication

- High-speed communication is possible for connections with both Mitsubishi and third party PLCs.

For connectable PLC models, see "List of connectable models" (page 65 to page 69).

Adjust brightness according to surroundings

GRAPHIC OPERATION TERMINAL GOT 1000

Backlight brightness adjustment

- Consider the conditions in the operation environment (daytime/nighttime etc.) and user comfort. You can adjust the brightness of the backlight while viewing the user screen.
- By using the script function or the status monitor function, you can automatically adjust the brightness according to conditions.

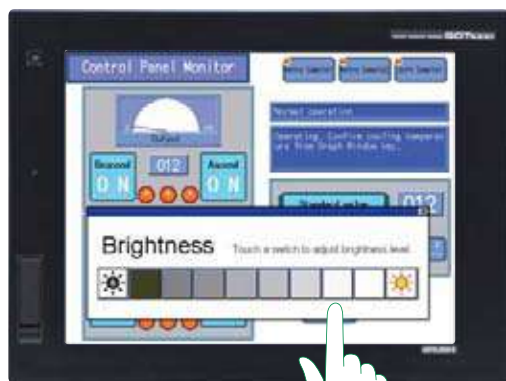

The touch switches for brightness adjustment are registered in the system library.

Easy-to recognize backlight state

GRAPHIC OPERATION TERMINAL GOT 1000

Color-coded front face LED

- The color of the LED on the front of the GOT unit indicates whether the backlight is OFF or has expired.

[Power LED: Color-coded message]

Green ON	When normal power is being applied	Orange/green blinking	When backlight life has expired
Orange ON	When in screen-save mode	OFF	When power is not being supplied

For planned commodity maintenance

GRAPHIC OPERATION TERMINAL GOT 1000

GT16 GT15 Maintenance time notification function

- The cumulative backlight ON time is automatically monitored, and the operator is notified when maintenance is required. This facilitates scheduled maintenance and prevents system malfunctions.

<Subject to be monitored> Backlight, display area, touch keys, and built-in flash memory

Warning! Backlight needs replacement soon.

An optional device may be necessary. For details, see "Selection of optional units and devices" (page 81).



GT16/GT15 response performance comparison

[Using MELSEC Q series] As of March 2012

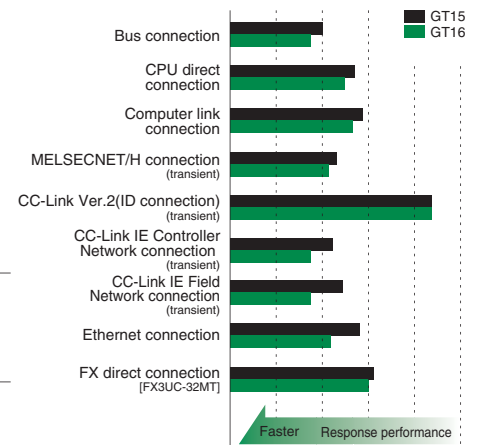

The monitor screen includes about 250 points of word devices.

To minimize production time, the GOT provides the user with worksite-required functions

For initial startup & operations

Easy data transmission without opening the cabinet

GRAPHIC OPERATION TERMINAL GOT 1000

Equipped with front USB interface*1

*1 : Back face layout for GT12.

USB device (Mini-B)

- Connect the USB device (Mini-B) port to a personal computer. You do not need to open the panel to transfer operating systems and project data or to use the FA transparent function.



* : To connect the GOT to a personal computer, use the dedicated USB cable. For more details, see "Product list" (page 74 to page 80).

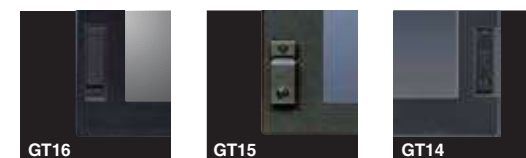

With USB environmental protection cover installed (standard feature) IP671 *

* : This does not guarantee protection in all users' environments.

USB host (TYPE-A) (For GT16/GT14 only)

- Operating systems, project data, and resource data can be stored in a USB memory device.
- A USB mouse/keyboard can also be used by connecting to the USB host interface.



* : The USB host interface of the GT14 model is on the rear side.

<Example of the use of a USB memory>

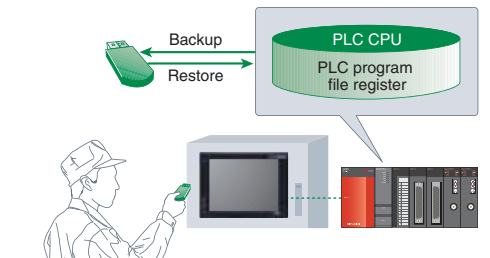

Sequence program and parameters can easily be modified at the worksite

GRAPHIC OPERATION TERMINAL GOT 1000

FA transparent function

- Connected with a personal computer, the GOT acts as a transparent gateway to enable programming, start up, and adjustment of FA equipment.
- Users do not have to bother with opening the cabinet or changing cable connections. (When using the USB interface)
- The FA transparent function can be used when a GOT and a personal computer are connected via USB, RS-232 or even using an Ethernet connection. (Supported only by GX Works2, MX Component/MX Sheet, MT Works2, MR Configurator2)
- When a GOT is directly connected to a FXCPU (CC-Link master station), CC-Link slave stations can be accessed from a personal computer. **NEW** (Connection between the GOT and the personal computer is USB or RS-232)

Supported software*

- MELSOFT Navigator
- GX Works2
- GX Developer
- GX Configurator-AD/DA/SC/CT/TI/TC/AS/FL/PT/QP
- PX Developer
- FX Configurator-FP
- FX3U-ENET-L Configuration Tool
- MT Works2
- MT Developer
- MR Configurator
- MR Configurator2
- FR Configurator
- RT ToolBox2
- NC Configurator
- MX Component/MX Sheet
- GX LogViewer
- LCPU Logging Configuration Tool

* : The version of the software depends on the system configuration. For more details, see the GOT1000 Series Connection Manual (Mitsubishi Products) for GT Works3.

* : For the software access range when using the FA transparent function, refer to the manual of the software being used.

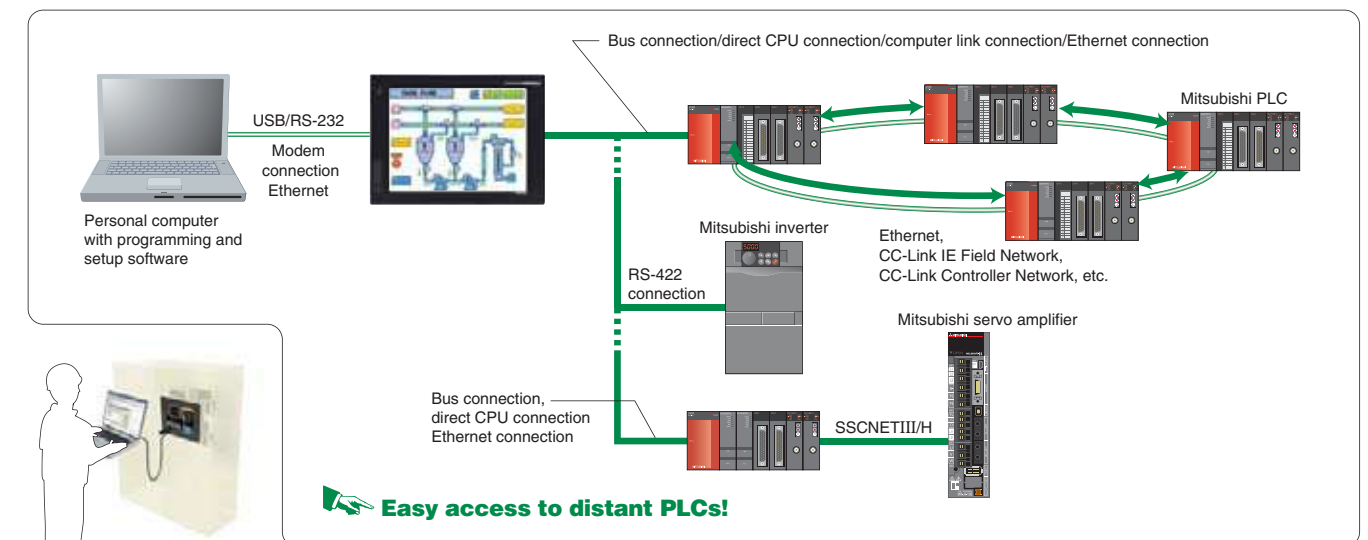

Easy access to distant PLCs!

INDEX

For Designers

For Initial Startup & Operations

For Maintenance Personnel

GT10

IQ Platform

MELSEC Process Control

Specifications, External Dimensions

List of Connectable Models, etc.

The GOT provides complete traceability for safe and secure operation

For maintenance personnel

Smooth operation from the collection of various data to storage of time-series data

Logging function/historical trend graph/historical data list display

- Collecting data from temperature controllers and other units with the GOT can reduce the load on the PLC.
- Logging data is saved in the built-in SRAM even during a power failure. (For GT16/GT14 only)

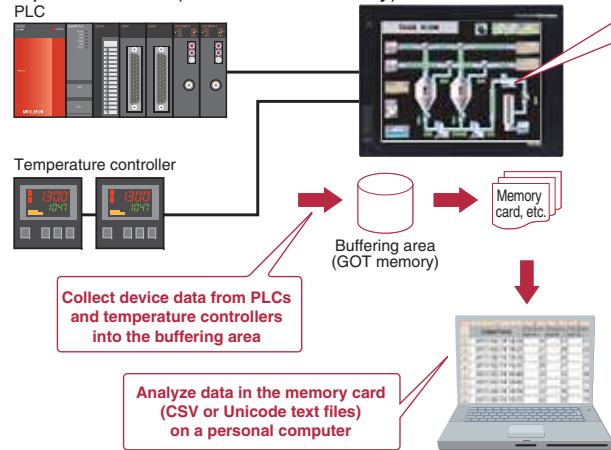

Display with graphs Historical trend graph

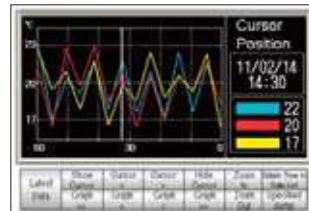

- After collecting data with the logging function, you can display the data in a time series.
- Scroll the view or specify the time so that you can check necessary data easily.
- Logging data to be displayed can be specified indirectly. **NEW**

Display with values Historical data list display

Time	Temp	A	Temp	B	Temp	C	Cursor Position
14:20	22	23	21				
14:25	21	20	22				
14:30	22	20	17				
14:35	23	21	21				
14:40	22	22	20				
14:45	21	21	21				

- Data collected with the logging function is displayed in list format.
- The historical trend graph for a specific time can be displayed by specifying the time.

Display logging data of a LCPU and high speed data logger module on the GOT

Log viewer function

Display logging data without a PC

- Logging data collected by a LCPU or high speed data logger module can be displayed on the GOT.
 - <Data to be displayed> Data logging (historical display)
- By displaying two cursors (multi-cursor), changes in data can easily be checked.
- The collected logging data can be searched for by time or index No. and displayed.



You do not need to have a PC onsite. Check logging data from the GOT, and you can take corrective actions quickly.

Logging data can be collected without opening the cabinet

- In a USB memory device attached to the USB interface on the front of the GOT, you can save logging data of the LCPU and high speed data logger module. In this way, you can collect the logging data easily with the GOT without removing the SD card from the LCPU or the CF card from the high speed data logger module.
- Connect a personal computer to the front USB interface of the GOT to view the LCPU logging data with the GX LogViewer, or to change the logging settings with the LCPU Logging Configuration Tool. (FA transparent function)

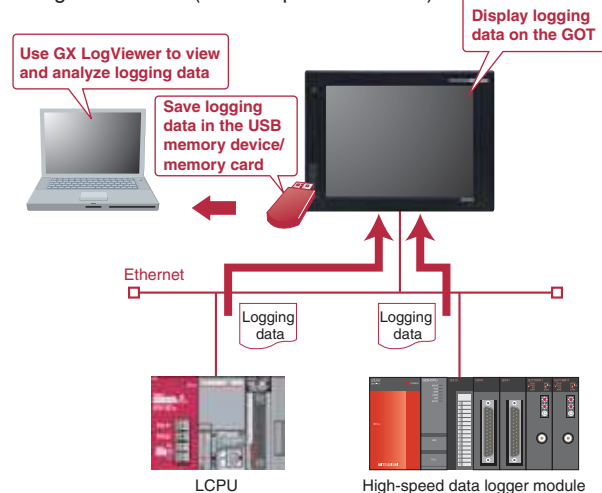

Enhanced security system using password control

Operator authentication function

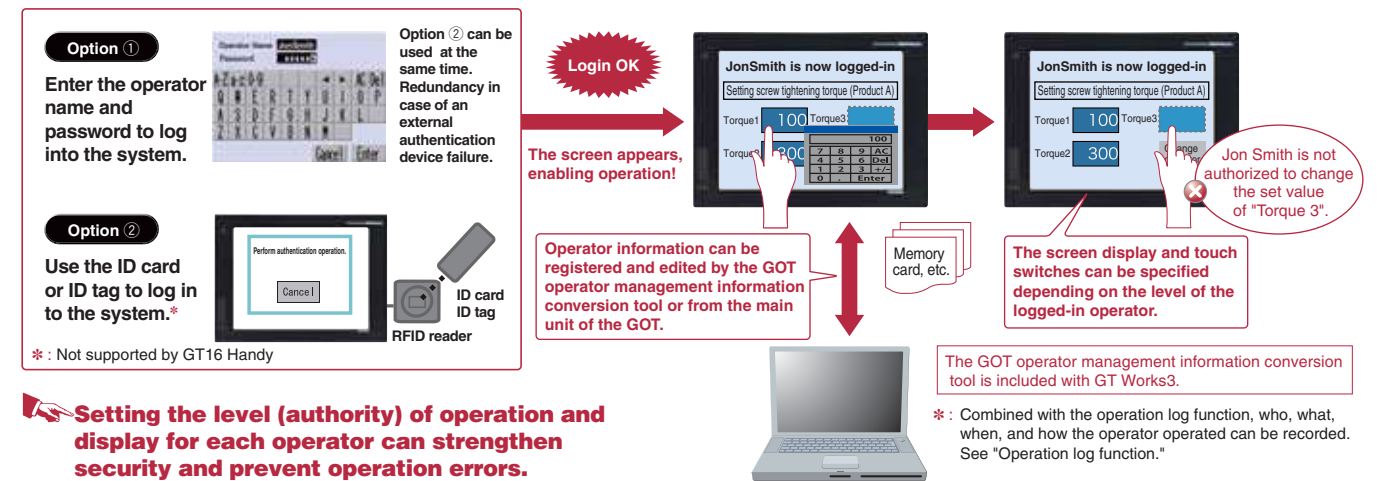

Very helpful for identification and analysis of causes of incorrect operation

Operation log function

- Operations performed by operators on the GOT can be recorded with respect to time, making it possible to check when, what, and how the operation was performed.

- List operations by type and easily search for specific device and GOT operation state changes.
 - <Specifiable operations> Touch switch operation, numerical value input operation, security level change, screen change, etc.
- Recorded log data is saved in the memory card and is available for checking on the GOT main unit or on a personal computer (CSV or Unicode text files).
 - * : Use of this function together with the operator authentication function enables recording of "who" has operated. See "Operator authentication function".

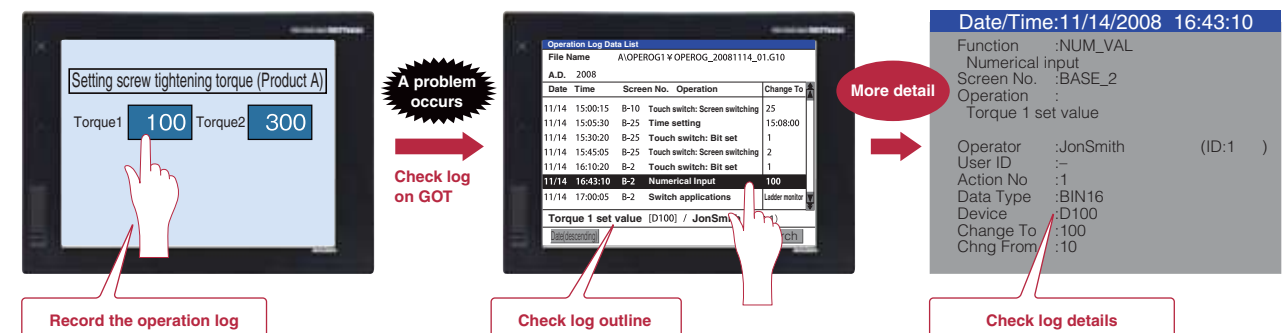

Refer to the operation log file, and investigate the problem source.

An optional device may be necessary. For details, see "Selection of optional units and devices" (page 81).

Example)
At 16:43:10 on November 14, 2008, Jon Smith changed the Numerical Input data entry to change the D100 value from 10 to 100 in "Torque 1 Set Value" on the BASE_2 screen.

INDEX
For Designers
For Initial Startup & Operations
For Maintenance Personnel
GT10
IQ Platform
MELSEC Process Control
Specifications, External Dimensions
List of Connectable Models, etc.

Back up important sequence programs for assurance in case of an emergency

Backup/restoration function

With backup and restore, fear troubles no more

- The sequence program and parameter data of the PLC CPU and motion controller, etc. can be backed up to the memory card in the GOT.
- Users can perform batch operation to restore the data to the PLC CPU or motion controller.

Example of use ①

Make a data backup in case of a PLC or CPU failure or a dead battery to quickly replace the faulty device and restore the system using the backup data in such a case.

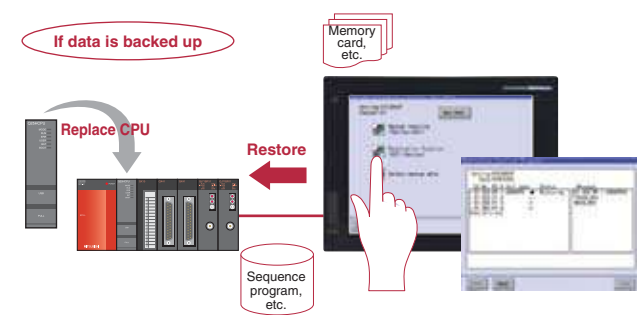

Example of use ②

When a problem occurs, or when the PLC CPU program is updated, the sequence program data can be transferred, analyzed, and corrected without requiring an experienced engineer, increasing time and cost efficiency.

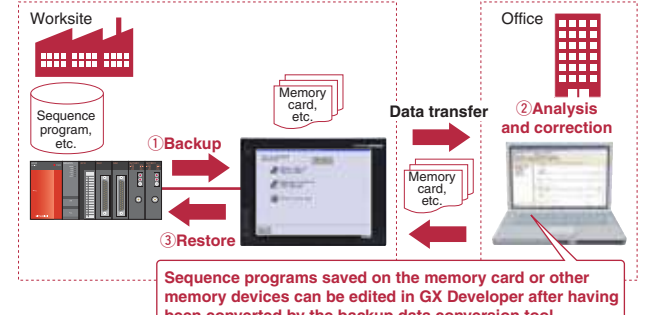

- <Objective data> Programs, parameters, device comments, device initial value data, file registers, etc.
- <Objective model> MELSEC Q-Series (excluding Q12PRH/Q25PRHCPU), L-Series, FX-Series, Q-Series motion controllers (SV13/SV22 only), CNC C70, Robot controller (CRnD-700, CRnQ-700)
- <Usable connection type> Bus connection, CPU direct connection, computer link connection, Ethernet connection

The backup data conversion tool is included with GT Works3.
 * : The backup data of Q00J/Q00/Q01CPU and FXCPU cannot be converted with the backup data conversion tool.
 * : Once backup data created with GX Works2 is converted by using the backup data conversion tool, the data cannot be edited with GX Works2.

PLC CPU programs can be easily changed without a personal computer at the worksite or any previous GX Developer knowledge.

* : When replacing the PLC CPU, the restoration function may not be available depending on the system configuration and connection type.

Backup multiple controllers at the same time

- Multiple controllers can be backed up at the same time over Ethernet. Target controllers for backup can be specified per station.

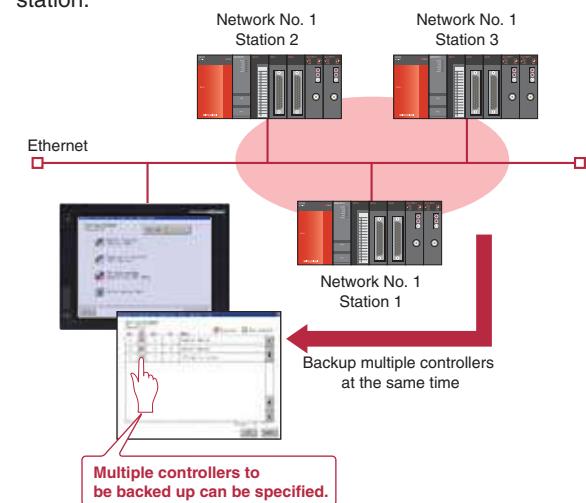

Automatic backup is available

- Besides automatic backup from touch switches, you can specify a trigger device, a day of the week, and time for automatic backup.

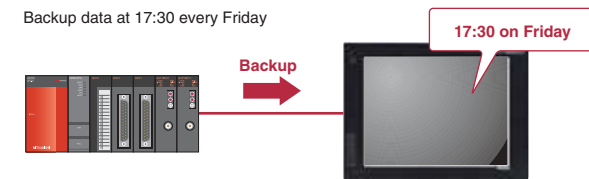

Password for enhanced security

- Define a password to perform password authentication when executing backup/restoration.

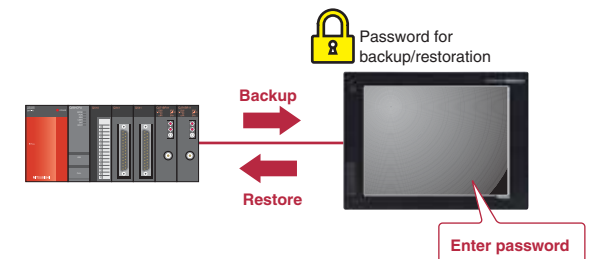

Clear communication minimizes machine downtime even during an alarm

Advanced alarm

A wider monitoring range protects even large-scale systems

- Alarm observation is possible for up to 32,767 devices with a maximum of 255 alarm observation setting groups.
- Batch display of large amounts of alarm information in large-scale systems, and unit-specific classification for easy management.
- Alarm log data can be saved in the built-in SRAM even during a power failure. (For GT16/GT14 only)

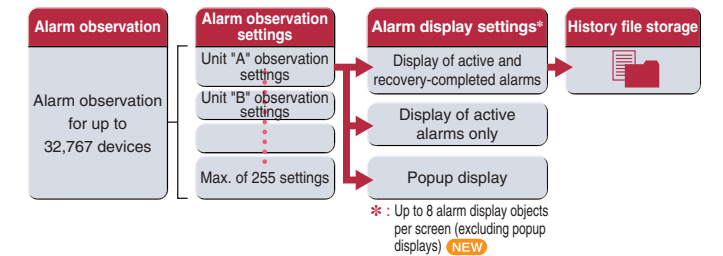

Rapid detection and corrective action for a wide array of alarms

Four-step alarm notification

- Alarm occurrence conditions can be divided into 4 steps and conveyed to the operator in an easy-to-understand, step-by-step format.
- The four-step display makes it easy to take in and sort out alarm conditions (information such as where, what, and how). This enables efficient troubleshooting when multiple problems occur.

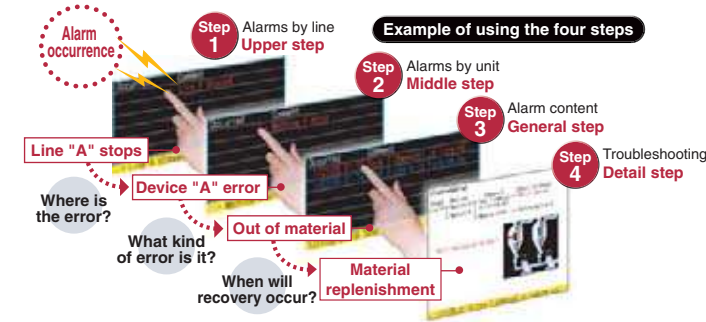

Group-specific & level-specific displays

- Alarms can be classified by group and level, with only specified alarms being displayed.

Alarm	Group	Level
M0	Transport G	Mid-level
M1	Transport G	Mid-level
M2	Transport G	Mid-level
M3	Transport G	Mid-level
M4	Transport G	Major
M5	Process G	Major
M6	Process G	Minor
M7	Process G	Minor
M8	Process G	Minor
M9	Process G	Minor

Easy searching with time designation

- Specify a time and easily check the required data.
- When used with the historical trend graph, by specifying the time at which an error appears to have occurred on the graph, the state of alarm occurrence at that time can easily be viewed.

Easy-to-understand display

- The use of colors and popups produce easily recognizable alarm displays.



Improved system alarms

- The PLC/GOT/Network monitoring subject can be specified in advance, with only those specified alarms being displayed.

Support in identifying alarm causes (utility function)

- Alarm occurrence conditions can be displayed in a time-series graph form.
- Alarm occurrence counts can be displayed in bar-graph form.



The GOT Ladder Monitor Function is greatly improved with the One-Touch Ladder Jump function

GT 16 GT 15 Ladder monitor function

MELSEC Q/QS/L/QnA/A/FX series PLCs, CNC C70, MELDAS C6/C64 sequence programs can be monitored in a circuit diagram (ladder format).

Defect search with the One-Touch Ladder Jump function (Q/L/QnA series, CNC C70)

- By setting a program name and coil number of the PLC to a touch switch, the relevant ladder circuit block can be displayed directly.

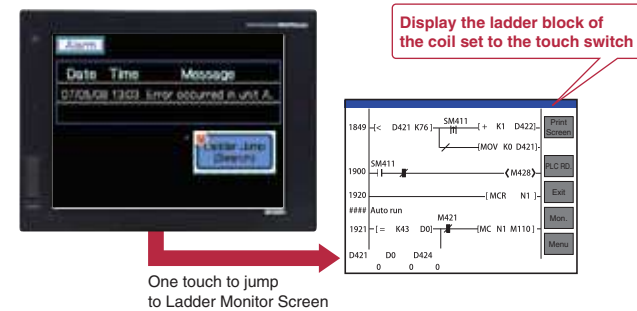

- * : Supported by XGA/SVGA/VGA models.
- * : QS series models can only monitor the ladder program of a Q/L/QnA. It cannot alter device values, for instance.
- * : FX3G(C) CPU is not supported.

- Select [SP Function]-[Ladder Monitor] from the touch switch property dialog.

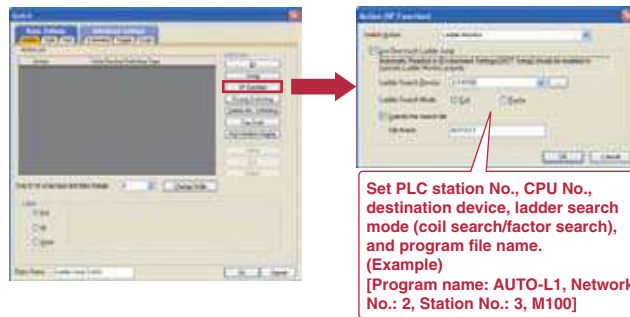

Wide monitoring range and useful functions make maintenance work more efficient!

- Not only connected PLCs, but also PLCs of other stations, multiple CPUs, multiple programs in the CPU, and local devices can be monitored.
- The programs and comments of multiple connected controllers can be saved in a memory card, so the ladder data can be switched and displayed without reading the data from the PLC.(Q/L/QnA series)
- Device values and timer (T) / counter (C) set values can be changed.
- Used together with the alarm history, a back-tracking ladder search can be performed to find the contact which triggered the alarm. <Defect search>
- Simply touching the Ladder Monitor screen can execute a coil search and contact point search. (Q/L/QnA series) <Touch search>
- The number of ladder program lines displayed on a XGA model has increased thus it is more user-friendly than ever.

Example of touch search (when error indicator light [Y10] is on)

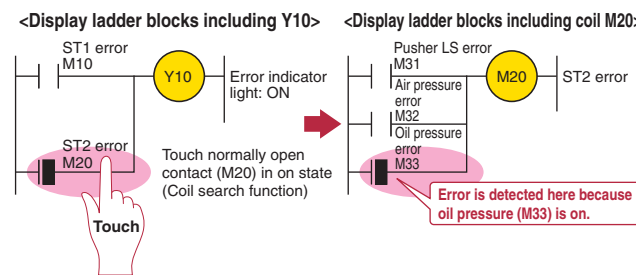

Since the source of operation halts and interlocks can be easily checked, unexpected problems can be detected quickly.

An optional device may be necessary. For details, see "Selection of optional units and devices" (page 81).

Monitor SFC programs on the GOT to make troubleshooting even easier

GT 16 GT 15 SFC monitor function

MELSEC Q/L series PLC SFC programs (MELSAP3, MELSAP-L) can be monitored in a graphical format.

- Viewing the block list or active step list enables you to see the complete status at a glance.
- Touch an SFC chart or a zoom window to specify a device. Then, the Ladder Monitor function displays other sequence programs that use the specified device.
- A device test can easily be conducted from a SFC chart or block list.
- Save programs and comments in the memory card of the GOT. They can be retrieved at a moment's notice.

* : Supported by XGA/SVGA/VGA models.

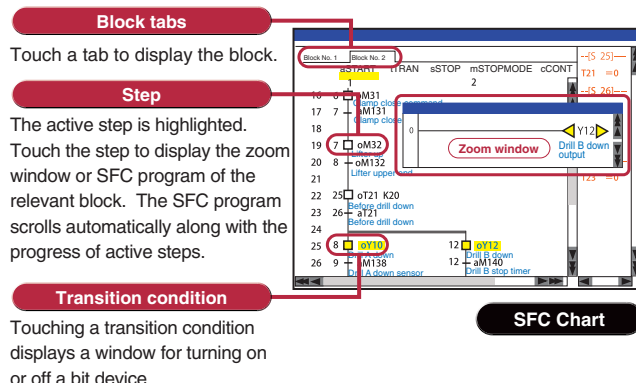

An optional device may be necessary. For details, see "Selection of optional units and devices" (page 81).

Simple and easy! Use the GOT to correct ladder programs, no need for a PC!

GT 16 GT 15 Ladder editor function

Sequence programs of MELSEC Q (Q mode)/L series PLCs and CNC C70 can be edited in the ladder format.

Ladder programs can easily be edited on the GOT at the worksite

- Just touch the portion (e.g. contact points, vertical lines) you want to edit in the ladder program. You can enter, change, or delete circuit symbols and devices. You can also insert or delete vertical lines and horizontal lines as well as columns and rows.

* : Supported by XGA/SVGA/VGA models excluding 5.7" types.
* : QnPHCPU/QnPRHCPU are not supported.

- Search and replace of devices makes it easy to locate the point to be edited. You can also make two or more modifications in one operation.
- Statements and notes can be edited.
- The details edited last can be restored (undone).

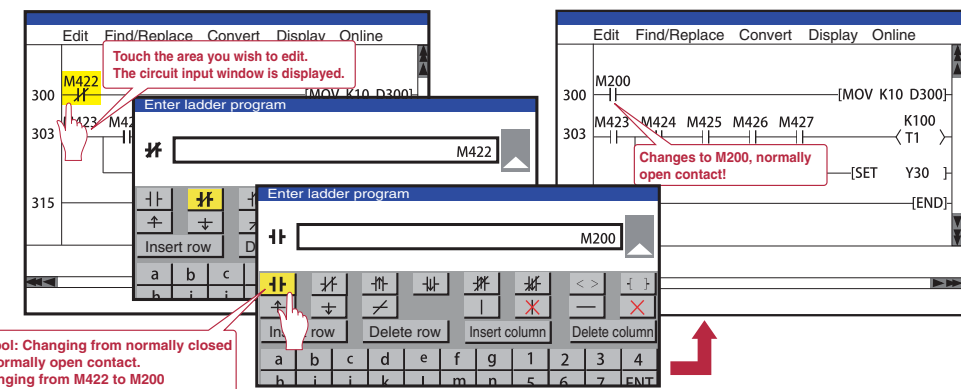

Writing into PLC while it is in operation

- Edited programs can be written from GOT to a PLC even if it is in operation. You do not need to stop equipment in operation to correct ladder programs.
- Remotely change the PLC's mode to "STOP" or "RUN" from the GOT.

Grasping CPU status with PLC diagnosis

- The CPU operation status and current errors can be monitored.

Long access range and convenient functions for efficient maintenance!

- Besides a directly connected PLC, you can edit multiple programs on another station's PLC, multi CPU, or CPU in the same network.
- You can view current values, perform a search, and conduct a device test.
- The one-touch ladder jump function is available. This is helpful to identify problem causes.

An optional device may be necessary. For details, see "Selection of optional units and devices" (page 81).

Use the GOT to monitor a motion SFC program

GT 16 GT 15 Motion SFC monitor function

Motion SFC programs of the Mitsubishi Motion Controller (Q Series) can be monitored.

- Viewing the batch program monitor or the active step list enables you to see the complete status at a glance.
- The detailed program window allows you to monitor programs and current values of operation control steps and transitions.
- Save programs in the memory card of the GOT. They can be retrieved at a moment's notice.

* : Supported by XGA/SVGA/VGA models.

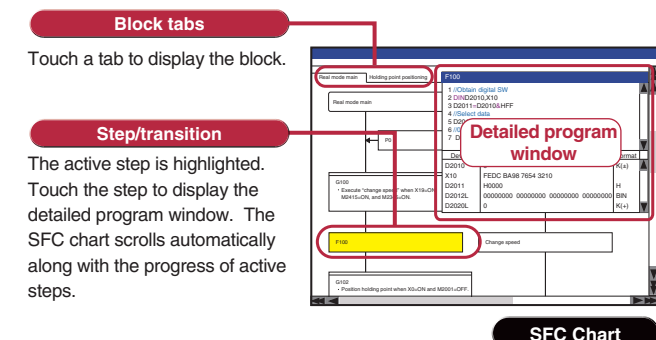

An optional device may be necessary. For details, see "Selection of optional units and devices" (page 81).

INDEX

For Designers

For Initial Startup & Operations

For Maintenance Personnel

GT10

IQ Platform

MELSEC Process Control

Specifications, External Dimensions

List of Connectable Models, etc.

Monitor and change Mitsubishi FA devices

GRAPHIC OPERATION TERMINAL GOT 1000

System monitor function

- The devices of PLCs, motion controllers, CNCs and robot controllers can be monitored and changed.
- * : Only monitoring, but not changing device values and other operations, is available with the QSCPU.
- The current values and setting values of timers (T) and counters (C) can be changed.
- The buffer memory (BM) of an intelligent function module can be monitored and changed.

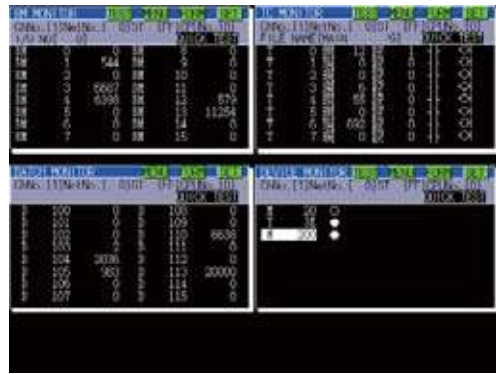

At-a-glance monitoring of network status

GRAPHIC OPERATION TERMINAL GOT 1000

Network monitor function

- Enable monitoring of network line conditions of the CC-Link IE Controller Network, CC-Link IE Field Network, MELSECNET/H, MELSECNET/10, and MELSECNET II on a dedicated screen.
- Communication line and information from the host and other stations can be monitored to check the communication status.

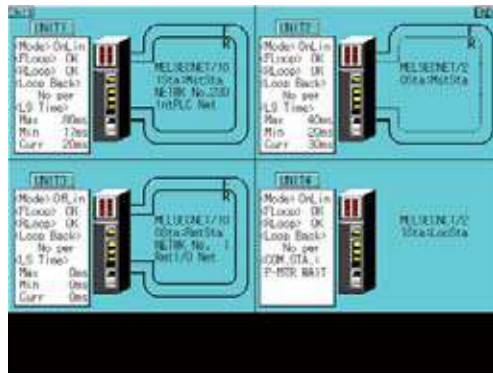

Easy adjustment of Q series motion controller

GRAPHIC OPERATION TERMINAL GOT 1000

Q series motion monitor function

- Up to 3 Q-type motion controllers can be used on a single base, with monitoring and parameter settings possible.
- Access to other stations is also possible.
- <Objective models>
- Q172DS/Q173DSCPU **NEW**
- Q172D/Q173DCPU (-S1) • Q170MCPUCPU
- Q172H/Q173HCPU • Q172(N)/Q173(N)CPU
- * : Supported only if the Q series motion controller CPU has the SV13/SV22 OS version. Moreover, available functions of the Q series motion monitor vary according to the CPU type or the servo amplifier model.

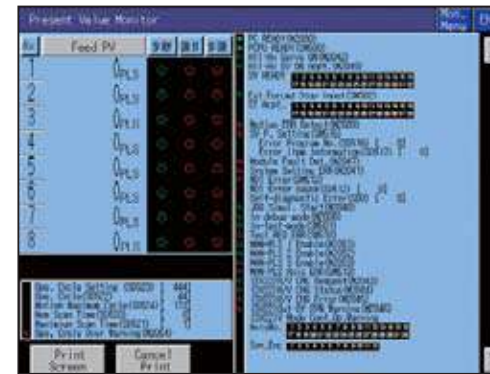

Easy startup and adjustment of a servo amplifier

GRAPHIC OPERATION TERMINAL GOT 1000

Servo amplifier monitor function

- In a system which outputs pulse strings, the GOT can be connected to a servo amplifier in a serial connection to perform the following operations: set up, monitoring, alarm display, diagnosis, parameter setting, and test operations.
- MR-J4-A is supported. **NEW**
- * : Available monitoring functions vary according to the servo amplifier type.



Easy-to-understand display of buffer memory values and I/O information

GRAPHIC OPERATION TERMINAL GOT 1000

Intelligent module monitor function

- Buffer memory values of intelligent function modules (e.g. QD75MH) and the ON/OFF status of I/O units can be monitored and changed.
- When a QCPU (Q mode), a QSCPU or a LCPU is in use, CPU operating status and existing errors can be monitored by PLC diagnosis.
- The status of the LCPU built-in I/O function can be checked.
- QD77MS, QD73A1, and LD75 are supported. **NEW**
- * : Supported by XGA/SVGA/VGA models.



Easy maintenance of MELSEC-L Series

GRAPHIC OPERATION TERMINAL GOT 1000

MELSEC-L troubleshooting function

- The maintenance screen dedicated to LCPU is installed. Without designing new screens and even without using a personal computer, you can check CPU status/error information easily.
- Just touch the dedicated screen. You can jump to a function screen such as the intelligent unit monitor to quickly take corrective actions on site.

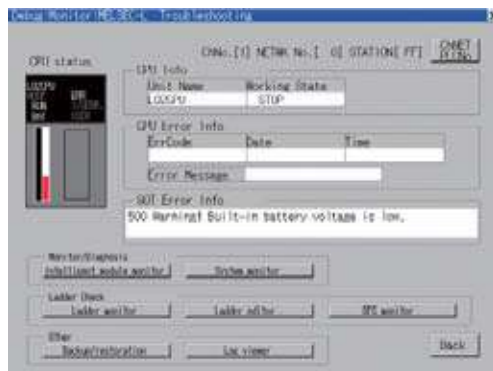

Save space and cost when no dedicated display device is required

GRAPHIC OPERATION TERMINAL GOT 1000

CNC monitor function/CNC data I/O function

- CNC monitor function**
- Connecting to a CNC (C70, C6/C64) enables functions such as position display and alarm diagnosis, and allows tool offset parameters to be set.
- CNC data I/O function**
- This function can be used to copy and delete CNC C70 work programs, parameters, etc.



* : Supported by XGA/SVGA models.

An optional device may be necessary. For details, see "Selection of optional units and devices" (page 81).

Convenient method for minor program changes onsite

GRAPHIC OPERATION TERMINAL GOT 1000

List editor for A/List editor for FX

- MELSEC-A series, FX series PLC sequence programs can be edited in list format (instruction word).
- Permits minor program changes onsite, even without a peripheral device.
- Used together with the ladder monitor function, the GT16 and GT15 can edit sequence programs while viewing the ladder data.



List editor for A

List editor for FX

Powerful features even down to the most basic

GT10

GOT

Various screen sizes

The GT10 now offers a line of models with 5.7" and 4.7" screens, enabling more flexible screen layouts. The 4.5" and 3.7" wide screen models are also available with a white frame.

GT1050/GT1055

5.7inch

- QVGA 320 × 240 dots
- Matrix touch panel
- Minimum touch key size: 16 × 16 dots
- Maximum number of touch keys: 50/Screen

GT1040/GT1045

4.7inch

- QVGA 320 × 240 dots
- Matrix touch panel
- Minimum touch key size: 16 × 16 dots
- Maximum number of touch keys: 50/Screen

Black frame

GT1030

4.5inch

- 288 × 96 dots
- Matrix touch panel
- Minimum touch key size: 16 × 16 dots
- Maximum number of touch keys: 50/Screen

White frame

GT1020

3.7inch

- 160 × 64 dots
- Analog touch panel
- Minimum touch key size: 2 × 2 dots
- Maximum number of touch keys: 50/Screen

Similar dimensions to the F900 Series allows for simple replacement without panel design changes*1

*1 : When the F940GOT is replaced with the GT1050/GT1055 or when the F930GOT is replaced with the GT1030

GT1050/GT1055

The GT1050, GT1055, and F940GOT are of the same size, 5.7", with the same LCD, QVGA 320 × 240 dots. They are highly compatible.

F940GOT ▶ GT1050/GT1055

● QVGA 320 × 240 dots in each model

GT1030

The GT1030 has the same panel mounting dimensions as the F930GOT yet with improved resolution*2.

F930GOT ▶ GT1030

*2 : 1.44 times higher resolution compared with the F930GOT

Resolution ×1.4

FA transparent function

When a GOT and a personal computer are connected, the FA devices can be programmed, started and adjusted via GOT.

GT1050/GT1055
GT1040/GT1045
GT1030 **GT1020**

Connect a PC with PLC via GOT.

GX Works2
GX Developer

FA transparent

Direct connection with FX/Q/L/QnACPU
Q/L/QnACPU serial communication unit connection etc.

GOT multi-drop connection

By using the serial multi-drop connection unit, the GT01-RS4-M, up to 16 GOT1000 units can be connected. The total distance can be up to 500m.

Mitsubishi PLC MELSEC Series FX, A, QnA or Q

* : See relevant manuals for connectable hardware and software versions.
* : GOT multi-drop connection is also available for GT16, GT15, GT14, GT12, and GT11.

Connection to Mitsubishi inverters and AC servos

Direct connection to Mitsubishi inverters and AC servo amplifiers with RS-485 makes it easy to adjust parameter settings etc.

Monitoring Parameter adjustment

Monitoring Operation commands

Can connect up to 32 axes of Mitsubishi general-purpose AC servos with a total extension of 500m.

Can connect up to 31 Mitsubishi general-purpose inverters with a total extension of 500m.

* : See relevant manuals for connectable hardware and software versions.

Common software functions

GT10 includes convenient functions of more advanced models in a compact package.

- Preinstalled OS to enable immediate use
- Choose your font
- A variety of alarm functions and window functions
- The recipe function and multi-action switch for reducing sequence program load
- Displaying custom startup screens
- Display in a variety of languages and comment switching function
- Screen save function
- Hard copy function **NEW** (connectable to a serial printer)

Functionality

Common	<ul style="list-style-type: none"> ○ Screen (base: max. 1,024 screens, window: max. 512 windows) ○ Fonts (standard (6 × 8 dots: Gothic, 16 dots: Gothic [except GT1020]/high quality/TrueType/Windows) ○ Screen switching function, screen call-up function, language switching function, password, system information, setting connected devices, and startup logo
Drawing and graphics	<ul style="list-style-type: none"> ○ Straight lines, continuous lines, rectangular, polygons, chamfered quadrangles, circles, ellipses, arcs, elliptic arcs, circular sectors, and elliptic sectors ○ Division indication ○ Painting ○ Images (BMP/DXF)
Objects	<ul style="list-style-type: none"> ○ Comment registration (basic comments and comment groups) ○ Parts registration ○ Data computing function ○ Offset function ○ Security function ○ Lamp indications ○ Touch switches ○ Numeric indications and input ○ ASCII indications and input ○ Clock function (GT1050, GT1055, GT1040, GT1045, GT1030: Integrated clock, GT1020: Read from the PLC clock) ○ Comment displays ○ Alarm list and alarm history ○ Parts display ○ Panel meters ○ Trend graphs, kinked line graphs, bar graphs, statistic crossbar graphs, statistic circular graphs ○ Status monitor function ○ Recipe function (4,000 points) ○ Time action function

* : See the manual for details.

Supporting the GT Works3 simulator function

Created screens can be easily debugged without an actual machine.

Easily debug with a PC

Click!

Using the GX Works2 simulator, the sequence program can also be debugged simultaneously.

* : Supported with GT Works3 Ver. 1.22Y or later.

Data transfer for improved user-friendliness and flexibility

Optional memory board and memory loader provide a convenient way to download project data and operating system data to terminals without a PC. Furthermore when downloading to multiple units speed and efficiency is increased.

Data transfer memory board GT10-50FMB

GT1050/GT1055
GT1040/GT1045

Install a memory board storing the newest data

Data can be read or written as shown in the utility window below.

Data is written at startup when two points are pressed on the screen.

Basic OS, communication driver, and project data

Read/Write

Memory loader GT10-LDR

GT1030 **GT1020**

- Has a compact design (70 × 110 mm), where the GOT transfer cable can be stored inside the body.
- Can write the standard monitor OS, communication driver, and project data.
- Can read the project data and resource data.
- Offers simple switch type operation, where the write-protect switch prevents erroneous reading.
- Does not require a power supply as power is supplied from the GOT or personal computer.

At the desk: Standard monitor OS, communication driver, project data, resource data*1

At the worksite: Standard monitor OS, communication driver, project data, resource data*2

Read/Write

Read/Write

PC (GT Works3)

USB cable (1m) packed together

RS-232 transfer cable (0.2m) incorporated

GT1020/GT1030

*1 : Only the standard monitor OS and communication driver can be written and only resource data can be read.
*2 : Only resource data can be read.

INDEX

For Designers

For Initial Startup & Operations

For Maintenance Personnel

GT10

IQ Platform

MELSEC Process Control

Specifications, External Dimensions

List of Connectable Models, etc.

Real-time multi CPU access with the iQ Platform



Mitsubishi FA Integrated Platform optimizes the front line of production

Platform

"iQ Platform," the next generation integrated platform

- integrated Q
- improved Quality
- intelligent & Quick
- innovation & Quest

With high speed control and convenience fully assured, controllers compatible with the iQ Platform and the GOT1000 are the keys to higher productivity at lower costs.

PLCs, motion controllers, CNCs, robot controllers, and C controllers are integrated into one as controllers compatible with the iQ Platform. The GOT1000 integrates different types of monitor units that were previously connected to each controller.

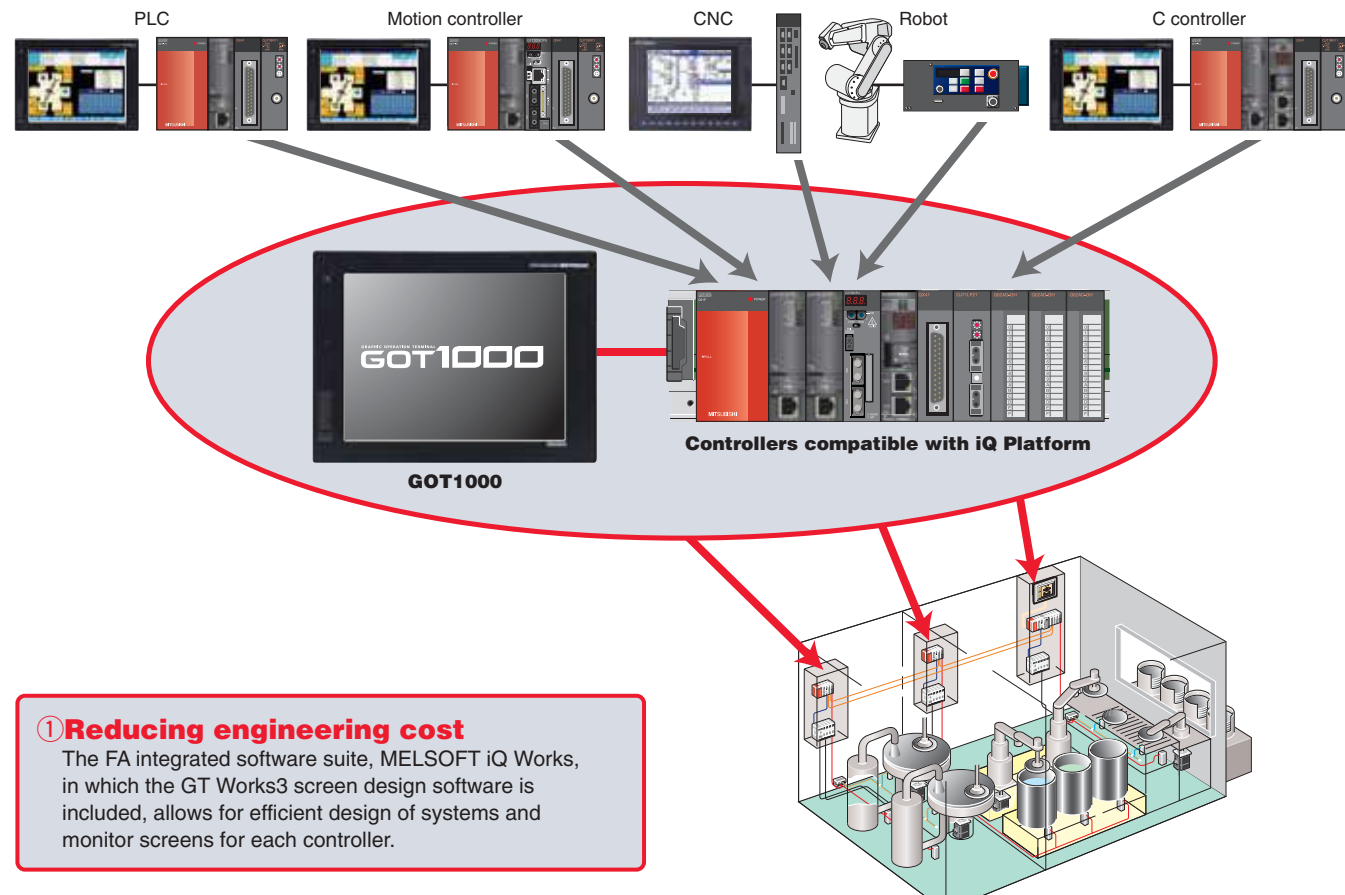

① Reducing engineering cost

The FA integrated software suite, MELSOFT iQ Works, in which the GT Works3 screen design software is included, allows for efficient design of systems and monitor screens for each controller.

② Reducing spare parts cost

A single GOT1000 can take the place of several types of monitor units, greatly reducing equipment cost.

③ Powerful support for maintenance

The GOT1000 has a variety of useful maintenance functions such as the "Q motion monitor function" and "CNC monitor function," very capable of and reliable for troubleshooting. (GT16 and GT15 only)

Quickly reduce total costs by creating a seamless integrated engineering environment.

MELSOFT iQ Works



- System Management Software [MELSOFT Navigator]
- Programmable Controller Engineering Software [MELSOFT GX Works2]
- Motion Controller Engineering Software [MELSOFT MT Works2]
- Servo Setup Software [MELSOFT MR Configurator2]
- Screen Design Software for Graphic Operation Terminal [MELSOFT GT Works3]
- Robot Programming Software [MELSOFT RT ToolBox2 mini]

Create an easy-to-operate process control system.

GOT1000 flexibly ties into process control.

MELSEC PROCESS CONTROL MELSEC will change process control. From dedicated systems to PLCs.

"MELSEC process control" is used in a wide range of applications from device process control to plant process control.

The GOT1000 can be used as the monitoring interface.

When used together with Mitsubishi FA devices, outstanding integration allows a high-performance process control monitor system to be created easily.

Four benefits that MELSEC process control and GOT1000 (GT16/GT15) can offer.

① PX Developer creates GOT process control monitor screens automatically

Based on the information such as tags defined by PX Developer, process control monitor screens for the GOT can be created automatically, greatly reducing the time required for screen design. GT Works3 can then customize the automatically created screens. By using the GT Works3 simulator function and GX Simulator, the operation of programs and screen data can be confirmed on a personal computer even without an actual machine.

*: For details on the compatible software version and functions, see the PX Developer Operating Manual.

[Screen examples that can be created automatically]



② Utilizing GOT1000 & GT SoftGOT1000 data

Only by using GT Works3 and PX Developer, a process control monitor system can be developed for both the worksite (GOT1000) and the remote monitoring location (GT SoftGOT1000). Screen data can be shared to monitor screens efficiently.

Worksite

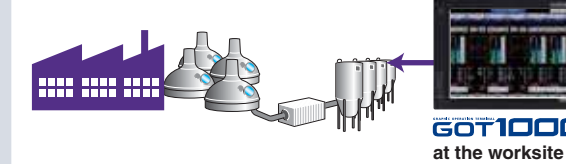

Monitoring location



- Excellent anti-environment performance (IP67f) for operation in various types of worksites.
- The VESA mount adapter is available.

- Touch switches on the GT SoftGOT1000 can call up screens such as face plates and the alarm list of the PX Developer monitor tool.
- Since GOT1000 screen data can be used for GT SoftGOT1000 without modification, no screens need to be created just for the monitoring location.

*: For more details, see "GT SoftGOT1000" (page 26)

③ Process control parts library

Library of process control parts has been added. This allows a process control graphic screen to be created easily.

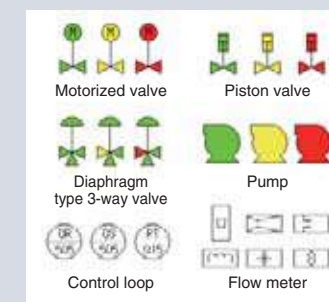

④ Various GOT1000 functions are available for process and duplex CPU

The various GOT1000 functions usable with process and duplex CPUs support the maintenance work of the process control system.

- Operation log function
- Operator authentication function
- Backup/restoration function, etc.

*: Connectable models and usable functions vary depending on the GOT main unit. For more details, see "List of connectable models" (page 65 to page 69), "Function list" (page 70 to page 73) and "Notes for use" (page 81 to page 86).

Specifications

GT16

General specifications

Item	Specification				
Operating ambient temperature ^{*1}	0°C to 50°C ^{*5} Other than display 0°C to 55°C ^{*5}				
Storage ambient temperature	-20°C to 60°C				
Operating ambient humidity	10 to 90%RH, no condensation				
Storage ambient humidity	10 to 90%RH, no condensation				
Vibration resistance	Conforming to JIS B 3502 and IEC 61131-2				
	Under intermittent vibration	5 to 8.4Hz 8.4 to 150Hz	Acceleration 9.8m/s ²	Half amplitude 3.5mm	Sweep count 10 times each in X, Y and Z directions
	Under continuous vibration	5 to 8.4Hz 8.4 to 150Hz	9.8m/s ² 4.9m/s ²	1.75mm	-
	Impact resistance	Conforming to JIS B 3502 and IEC 61131-2 (147m/s ² , 3 times each in X, Y and Z directions)			
	Operating atmosphere	No oily smoke, corrosive gas or combustible gas, less conductive dust, away from direct sunlight (the same in storage)			
Operating altitude ^{*2}	2000m or less				
Installation location	In control panel ^{*6}				
Overvoltage category ^{*3}	II or lower				
Contamination level ^{*4}	2 or less				
Cooling method	Self-cooling				
Grounding	Type D grounding (100Ω or less). Connect to panel if unable to ground.				

^{*1}: The maximum operating ambient temperature should be 5°C lower than that shown in the table on the left when connecting to a multimedia unit (GT16M-MMR), MELSECNET/H communication unit (GT15-J71LP23-25 or GT15-J71BR13) or CC-Link communication unit (GT15-J61BT13).

^{*2}: Do not operate or store the GOT in pressurized environments where the pressure exceeds 0m elevation atmospheric pressure, as this could result in abnormal operation. Do not pressurize inside the control panel for air purge cleaning. The pressure could raise the surface sheet, making the touch panel difficult to operate or causing the sheet to come off.

^{*3}: Assuming that the device is connected at some point between a public power distribution network and local system equipment. Category II applies to devices that are supplied with power from fixed equipment. The surge withstand voltage is 2,500V for devices with ratings up to 300V.

^{*4}: Index that indicates the level of foreign conductive matter in the operating environment of the device. Contamination level 2 denotes an environment contaminated only by non-conductive matter which may, under certain conditions, become temporarily conductive due to condensation.

^{*5}: 0 to 40°C for GT1665HS

^{*6}: Excluding GT1665HS

Do not use or store the GOT under direct sun light or in an environment with excessively high temperature, dust, humidity or vibration.

For inquiries relating to products which conform to UL, cUL, and CE directives and shipping directives, please contact your local sales office.

Performance specifications

Item	Specification						
	GT1695M-XTBA GT1695M-XTBD	GT1685M-STBA GT1685M-STBD	GT1675M-STBA GT1675M-STBD	GT1675M-VTBA GT1675M-VTBD	GT1675-VNBA GT1675-VNBD	GT1672-VNBA GT1672-VNBD	GT1665M-STBA GT1665M-STBD
Type	TFT color LCD (high-brightness, wide viewing angle)			TFT color LCD		TFT color LCD (high-brightness, wide viewing angle)	
Screen size	15"	12.1"	10.4"		8.4"		
Resolution	XGA: 1024 x 768 [dots]	SVGA: 800 x 600 [dots]	VGA: 640 x 480 [dots]		SVGA: 800 x 600 [dots]		
Display size	304.1(W) x 228.1(H)[mm]	246(W) x 184.5(H)[mm]	211(W) x 158(H)[mm]		171(W) x 128(H)[mm]		
No. of displayed characters	16-dot standard font: 64 chars. x 48 lines (2-byte) 12-dot standard font: 85 chars. x 64 lines (2-byte)	16-dot standard font: 50 chars. x 37 lines (2-byte) 12-dot standard font: 66 chars. x 50 lines (2-byte)	16-dot standard font: 40 chars. x 30 lines (2-byte) 12-dot standard font: 53 chars. x 40 lines (2-byte)		16-dot standard font: 50 chars. x 37 lines (2-byte) 12-dot standard font: 66 chars. x 50 lines (2-byte)		
Display colors	65,536 colors		4,096 colors	16 colors	65,536 colors		
View angle ^{*2}	Right/left: 75°, Up: 50°, Down: 60°	Right/left: 80°, Up: 60°, Down: 80°	Right/left/up/down: 88°	Right/left: 80°, Up: 80°, Down: 60° ^{*14}	Right/left: 45°, Up: 30°, Down: 20°		Right/left: 80°, Up: 80°, Down: 60°
Intensity	450 [cd/m ²]	470 [cd/m ²]	400 [cd/m ²]	500 [cd/m ²] ^{*15}	200 [cd/m ²]	400 [cd/m ²]	
Intensity adjustment	8-step adjustment		4-step adjustment		8-step adjustment		
Life	Approx. 52,000 hours (operating ambient temperature: 25°C)		Approx. 43,000 hours (operating ambient temperature: 25°C)		Approx. 52,000 hours (operating ambient temperature: 25°C)		Approx. 43,000 hours (operating ambient temperature: 25°C)
Backlight	Cold-cathode fluorescent tube (replaceable), with backlight OFF detection function. Backlight off time and screen save time can be set.						
Life ^{*3}	Approx. 50,000 hours or more (Time for display intensity reaches 50% at operating ambient temperature of 25°C)						
Touch panel	Analog resistive type						
Key size	Min. 2 x 2 [dots] (per key)						
No. of simultaneous touch points	Simultaneous touch prohibited ^{*4} (If two or more points are pressed simultaneously, the switch may function near the center of the pressed points.)						
Life ^{*11}	1,000,000 times or more (operating force 0.98N or less)						
Detection distance	1 [m]		-				
Detection range	Right/left/up/down: 70°		-				
Detection delay time	0 to 4 [sec]		-				
Detection temperature	Temperature difference to be 4°C or more between human body and ambient air		-				
C drive	15MB built-in flash memory (for saving project data and OS)		11MB built-in flash memory (for saving project data and OS)		15MB built-in flash memory (for saving project data and OS)		
Life (No. of writings)	100,000 times						
Internal clock accuracy	3.47 to 8.38 secs/day (operating ambient temperature: 25°C) ^{*12}						
Battery	GT15-BAT type lithium battery						
Backed up data	Clock data, maintenance time notification data, system log data and SRAM user area (500KB)						
Life	Approx. 5 years (operating ambient temperature: 25°C)						
RS-232 ^{*7}	RS-232, 1ch Transmission speed: 115200/57600/38400/19200/9600/4800bps Connector shape: D-sub 9-pin (male) Application: Communication with connected devices, connection to personal computer (project data read/write, OS installation, FA transparent function)						
RS-422/485	RS-422/485, 1ch Transmission speed: 115200/57600/38400/19200/9600/4800bps Connector shape: 14-pin (female) Application: Communication with connected devices						
Ethernet	Data transfer system: 100BASE-TX, 10BASE-T, 1ch Connector shape: RJ-45 (modular jack) Application: Communication with connected devices, gateway function, connection to personal computer (project data read/write, OS installation, FA transparent function)						
USB	USB (full-speed 12Mbps), host 1ch Connector shape: TYPE-A Application: USB mouse/keyboard connection, USB memory data transfer and storage FAT16 format: max. 2GB, FAT32 format: max. 32GB ^{*13}						
CF card	Compact flash slot, 1ch Connector shape: TYPE I Application: Data transfer, data storage, GOT startup FAT16 format: max. 2GB, FAT32 format: max. 32GB ^{*13}						
Optional function board	1ch for optional function board installation						
Extension unit ^{*7}	2ch for communication unit/optional unit installation						
Buzzer output	Single tone (tone length adjustable)						
Protective construction	Front: IP67 ^{*8} In panel: IP2X						
External dimensions	397(W) x 296(H) x 61(D)[mm]	316(W) x 242(H) x 52(D)[mm]	303(W) x 214(H) x 49(D)[mm]		241(W) x 190(H) x 52(D)[mm]		
Panel cut dimensions	383.5(W) x 282.5(H)[mm]	302(W) x 228(H)[mm]	289(W) x 200(H)[mm]		227(W) x 176(H)[mm]		
Weight (excl. mounting brackets)	5.0[kg]	2.7[kg]	2.1[kg]	2.3[kg] ^{*16}	2.3[kg]	1.7[kg]	
Applicable software packages	GT Works3 Version 1.54G or later			GT Works3 Version 1.54G or later (not supported by GT Works2/GT Designer2)		GT Works3 Version 1.54G or later	

Power supply specifications

Item	Specification							
	GT1695M-XTBA	GT1685M-STBA	GT1675M-STBA GT1675M-VTBA GT1672-VNBA GT1665M-STBA GT1665M-VTBA GT1662-VNBA	GT1695M-XTBD	GT1685M-STBD	GT1675M-STBD GT1675M-VTBD GT1672-VNBD GT1665M-STBD GT1665M-VTBD GT1662-VNBD	GT1665-VTBD	GT1665HS-VTBD
Input power supply voltage	100 to 240VAC (+10%, -15%)			24VDC (+25%, -20%)			24VDC (+10%, -15%)	
Input frequency	50/60Hz ±5%			-			-	
Input maximum apparent power	150VA (at max. load)	110VA (at max. load)	100VA (at max. load)	-			-	
Power consumption	64W or less	46W or less	39W or less	60W or less	40W or less	38W or less	16W or less	11.6W or less
With backlight off	38W or less	32W or less	30W or less	30W or less	26W or less	27W or less	14W or less	8.2W or less
Inrush current	28A or less (4ms, at max. load)			12A or less (75ms, at max. load)	12A or less (55ms, at max. load)		67A or less (1ms, at max. load)	30A or less (2ms, at max. load)
Permissible instantaneous failure time	Within 20ms (100VAC or more)			Within 10ms			Within 5ms	
Noise resistance	Noise voltage 1500Vp-p, noise width 1μs by noise simulator with noise frequency 25 to 60Hz			Noise voltage 500Vp-p, noise width 1μs by noise simulator with noise frequency 25 to 60Hz			Noise voltage 1000Vp-p, noise width 1ms by noise simulator with noise frequency 30 to 100Hz	
Withstand voltage	1500VAC for 1 minute between power supply terminal and ground			500VDC for 1 minute between power supply terminal and ground			-	
Insulation resistance	10MΩ or higher with an insulation resistance tester (500VDC between power supply terminal and ground)							-
Applicable wire size	0.75 to 2 [mm ²]							-
Clamp terminal	Clamp terminals for M3 screw RAV1.25-3, V2-S3.3, V2-N3A, FV2-N3A							-
Tightening torque (terminal block's terminal screws)	0.5 to 0.8 [N·m]							-

Performance specifications

Item	Specification			
	GT1665M-VTBA GT1665M-VTBD	GT1662-VNBA GT1662-VNBD	GT1665-VTBD	GT1665HS-VTBD
Type	TFT color LCD (high-brightness, wide viewing angle)	TFT color LCD	TFT color LCD (high-brightness, wide viewing angle)	
Screen size	8.4"	5.7"	6.5"	
Resolution	VGA: 640 x 480 [dots]			
Display size	171(W) x 128(H)[mm]	115(W) x 86(H)[mm]	132.5(W) x 99.4(H)[mm]	
No. of displayed characters	16-dot standard font: 40 chars. x 30 lines (2-byte) 12-dot standard font: 53 chars. x 40 lines (2-byte)			
Display colors	65,536 colors	16 colors	65,536 colors	
View angle ^{*2}	Right/left: 80°, Up: 80°, Down: 60°	Right/left: 45°, Up/Down: 20°	Up/down/right/left: 80°	Right/left: 80°, Up: 60°, Down: 80°
Intensity	600 [cd/m ²]	200 [cd/m ²]	350 [cd/m ²]	550 [cd/m ²]
Intensity adjustment	8-step adjustment	4-step adjustment	8-step adjustment	
Life	Approx. 43,000 hours (operating ambient temperature: 25°C)	Approx. 52,000 hours (operating ambient temperature: 25°C)	Approx. 50,000 hours (operating ambient temperature: 25°C)	Approx. 41,000 hours (operating ambient temperature: 25°C)
Backlight	Cold-cathode fluorescent tube (replaceable), with backlight OFF detection function. Backlight off time and screen save time can be set.			
Life ^{*3}	Approx. 50,000 hours or more (Time for display intensity reaches 50% at operating ambient temperature of 25°C)			
Touch panel	Analog resistive type			
Key size	Min. 2 x 2 [dots] (per key)			
No. of simultaneous touch points	Simultaneous touch prohibited ^{*4} (If two or more points are pressed simultaneously, the switch may function near the center of the pressed points.)			
Life ^{*11}	1,000,000 times or more (operating force 0.98N or less)			
Detection distance	-			
Detection range	-			
Detection delay time	-			
Detection temperature	-			
C drive	15MB built-in flash memory (for saving project data and OS)	11MB built-in flash memory (for saving project data and OS)	15MB built-in flash memory (for saving project data and OS)	
Life (No. of writings)	100,000 times			
Internal clock accuracy	3.47 to 8.38 secs/day (operating ambient temperature: 25°C) ^{*12}	-3.61 to 2.16 secs/day (operating ambient temperature: 25°C) ^{*12}	3.47 to 8.38 secs/day (operating ambient temperature: 25°C) ^{*12}	
Battery	GT15-BAT type lithium battery			
Backed up data	Clock data, maintenance time notification data, system log data and SRAM user area (500KB)			
Life	Approx. 5 years (operating ambient temperature: 25°C)			
RS-232 ^{*7}	RS-232, 1ch Transmission speed: 115200/57600/38400/19200/9600/4800bps Connector shape: D-sub 9-pin (male) Application: Communication with connected devices, connection to personal computer (project data read/write, OS installation, FA transparent function)			
RS-422/485	RS-422/485, 1ch Transmission speed: 115200/57600/38400/19200/9600/4800bps Connector shape: 14-pin (female) Application: Communication with connected devices			
Ethernet	Data transfer system: 100BASE-TX, 10BASE-T, 1ch Connector shape: RJ-45 (modular jack) Application: Communication with connected devices, gateway function, connection to personal computer (project data read/write, OS installation, FA transparent function)			
USB	USB (full-speed 12Mbps), host 1ch Connector shape: TYPE-A Application: USB mouse/keyboard connection, USB memory data transfer and storage FAT16 format: max. 2GB, FAT32 format: max. 32GB ^{*13}			
CF card	Compact flash slot, 1ch Connector shape: TYPE I Application: Data transfer, data storage, GOT startup FAT16 format: max. 2GB, FAT32 format: max. 32GB ^{*13}			
Optional function board	1ch for optional function board installation			
Extension unit ^{*7}	2ch for communication unit/optional unit installation			
Buzzer output	Single tone (tone length adjustable)			
Protective construction	Front: IP67 ^{*8} In panel: IP2X			
External dimensions	241(W) x 190(H) x 52(D)[mm]	267(W) x 135(H) x 60(D)[mm]	201(W) x 230(H) x 97(D)[mm]	
Panel cut dimensions	227(W) x 176(H)[mm]	153(W) x 121(H)[mm]	-	
Weight (excl. mounting brackets)	1.7[kg]	1.8[kg]	1.0[kg]	1.2[kg] (main unit only)
Applicable software packages	GT Works3 Version 1.54G or later	GT Works3 Version 1.54G or later (not supported by GT Works2/GT Designer2)	GT Works3 Version 1.54G or later	

Component names

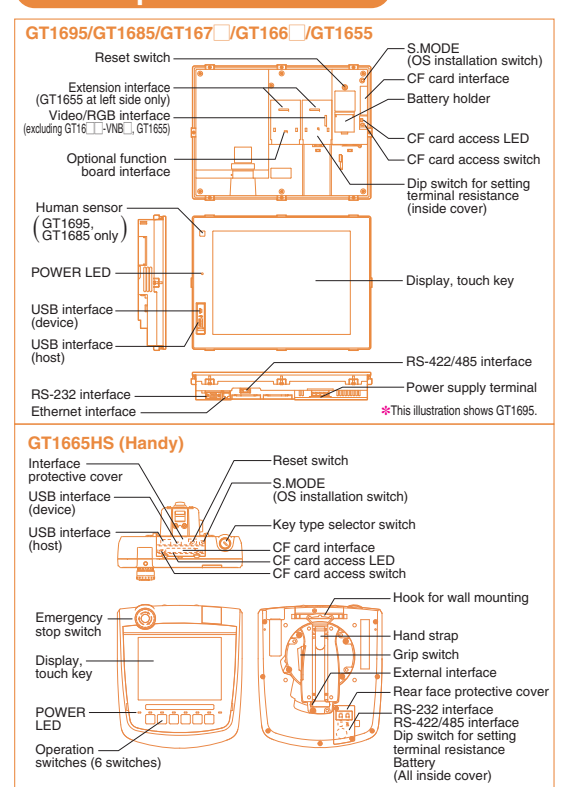

- ^{*1} On LCD panels, bright dots (permanently lit) and black dots (never lit) generally appear. Because the number of display elements that exist on an LCD panel is large, it is not possible to reduce appearance of the bright and black dots to zero.
- ^{*2} Individual differences in LCD panels may cause differences in color, uneven brightness and flickering. Note that this is a characteristic of LCD panels and it does not mean the products are defective or damaged.
- ^{*3} LCD panels have characteristics of tone reversal. Note that even within the indicated viewing angles, the screen display may not be clear enough depending on the display color.
- ^{*4} Using the GOT screen save/backlight OFF functions prevents screen burn-in and extends backlight life.
- ^{*5} An analog resistive touch display is used. When 2 points on the screen are touched simultaneously, if a switch is located the middle of the 2 points then the switch will be activated. Therefore, avoid touching 2 points on the screen simultaneously.
- ^{*6} The memory is ROM that having overwritten of new data without having to delete the existing data.
- ^{*7} With the USB environmentally protective cover is on, pressing firmly the portion marked "X" makes it conform to IP67. (The USB interface conforms to IP2X when a USB cable or a USB memory is connected.) However, this does not guarantee protection in all users' environments. The unit may not be used in an environment where it is exposed to splashing oil or chemicals for a long time or it is soaked with oil mist.
- ^{*8} Where more than one extension unit, barcode reader, and RFID controller are used, the sum of their current consumptions should be within the current level which the GOT can supply.
- ^{*9} For the currents which the extension units, barcode reader, and RFID controller consume and the current level which the GOT can supply, see "Notes for use" (page 81 to page 86).
- ^{*10} The function version A of GT1695/GT1685 is not compatible with 10BASE-T.
- ^{*11} The degree of protection is not guaranteed under all users' environmental conditions. If the interface protective cover or the rear face protective cover is removed, the specification does not apply.
- ^{*12} If necessary, use a stylus pen meeting the following specifications.
- ^{*13} USB memory and CF cards that can store more than 2GB.
- ^{*14} Material: Polyacetal resin • Per point radius: 0.8mm or more (The stylus pen cannot be used with the GT1665HS.)
- ^{*15} When using a stylus pen, it will be 100,000 times or more (operating force 0.98N max.).
- ^{*16} Since the touch panel is a consumable product structurally, it may not be used even fewer than above, depending on the usage method and environment.
- ^{*17} If the operating ambient temperature is other than 25°C, operation errors may increase.
- ^{*18} Standard monitor OS version: 05.09.00 or later
- ^{*19} With OSs earlier than the above versions, the GOT cannot correctly recognize the USB memory and the CF card that store more than 2GB.
- ^{*20} If the above versions of OSs are not installed, install the OSs on the GOT by using GT Designer3 with version 1.17T or later. GT Designer2 version 1.1 is not compatible with USB memory and CF cards that can store more than 2GB.
- ^{*21} 88" in each direction for function version C or earlier.
- ^{*22} 450 [cd/m²] for function version C or earlier.
- ^{*23} 2.1 [kg] for function version C or earlier.

INDEX

For Designers

For Initial Startup & Operations

For Maintenance Personnel

GT10

IQ Platform

MELSEC Process Control

Specifications, Models, etc.

List of Connectable

External Dimensions

Specifications

GT15

General specifications

Item	Specification				
Operating ambient temperature ^{*1}	0°C to 50°C				
Other than display	0°C to 55°C				
Storage ambient temperature	-20°C to 60°C				
Operating ambient humidity ^{*2}	10 to 90%RH, no condensation				
Storage ambient humidity ^{*2}	10 to 90%RH, no condensation				
Vibration resistance ^{*3}	Conforming to JIS B 3502 and IEC 61131-2				
	Under intermittent vibration	5 to 8.4Hz 8.4 to 150Hz	Acceleration - 9.8m/s ²	Half amplitude 3.5mm -	Sweep count 10 times each in X, Y and Z directions -
	Under continuous vibration	5 to 8.4Hz 8.4 to 150Hz	- 4.9m/s ²	1.75mm -	-
	Conforming to JIS B 3502 and IEC 61131-2 (147m/s ² , 3 times each in X, Y and Z directions)				
Impact resistance	Conforming to JIS B 3502 and IEC 61131-2 (147m/s ² , 3 times each in X, Y and Z directions)				
Operating atmosphere	No oily smoke, corrosive gas or combustible gas, less conductive dust, away from direct sunlight (the same in storage)				
Operating altitude ^{*4}	2000m or less				
Installation location	In control panel				
Overvoltage category ^{*5}	II or lower				
Contamination level ^{*6}	2 or less				
Cooling method	Self-cooling				
Grounding	Type D grounding (100Ω or less). Connect to panel if unable to ground.				

- *1: The maximum operating ambient temperature should be 5°C lower than that shown in the table on the left when connecting to a MELSECNET/H communication unit (GT15-J71LP23-25 or GT15-J71BR13) or CC-Link communication unit (GT15-J61BT13).
- *2: Water bulb temperature for STN display type must be 39°C or lower.
- *3: Refer to the Communication Unit User's Manual for vibration resistance specifications when using the MELSECNET/H communication unit (GT15-J71LP23-Z or GT15-J71BR13-Z) or CC-Link communication unit (GT15-J61BT13-Z). (The specifications of communication units are different from those of the GOT main unit.)
- *4: Do not operate or store the GOT unit in pressurized environments where the pressure exceeds 0m elevation atmospheric pressure, as this could result in abnormal operation.
- *5: Do not pressurize inside the control panel for air purge cleaning. The pressure could raise the surface sheet, making the touch panel difficult to operate or causing the sheet to come off.
- *6: Assuming that the device is connected at some point between a public power distribution network and local system equipment. Category II applies to devices that are supplied with power from fixed equipment. The surge withstand voltage is 2,500V for devices with ratings up to 300V. Index that indicates the level of foreign conductive matter in the operating environment of the device. Contamination level 2 denotes an environment contaminated only by non-conductive matter which may, under certain conditions, become temporarily conductive due to condensation.

Do not use or store the GOT under direct sun light or in an environment with excessively high temperature, dust, humidity or vibration.

For inquiries relating to products which conform to UL, cUL, and CE directives and shipping directives, please contact your local sales office.

Performance specifications

Item	Specification							
	GT1595-XTBA GT1595-XTBD	GT1585V-STBA GT1585V-STBD GT1585-STBA GT1585-STBD	GT1575V-STBA GT1575V-STBD GT1575-STBA GT1575-STBD	GT1575-VTBA GT1575-VTBD	GT1575-VNBA GT1575-VNBD	GT1572-VNBA GT1572-VNBD	GT1565-VTBA GT1565-VTBD	GT1562-VNBA GT1562-VNBD
Type	TFT color LCD (high-brightness, wide viewing angle)			TFT color LCD		TFT color LCD (high-brightness, wide viewing angle)	TFT color LCD	
Screen size	15"	12.1"	10.4"		8.4"			
Resolution	XGA: 1024 x 768 [dots]	SVGA: 800 x 600 [dots]	VGA: 640 x 480 [dots]					
Display size	304.1(W) x 228.1(H) [mm]	246(W) x 184.5(H) [mm]	211(W) x 158(H) [mm]		171(W) x 128(H) [mm]			
No. of displayed characters	16-dot standard font: 64 chars. x 48 lines (2-byte) 12-dot standard font: 85 chars. x 64 lines (2-byte)	16-dot standard font: 50 chars. x 37 lines (2-byte) 12-dot standard font: 66 chars. x 50 lines (2-byte)	16-dot standard font: 40 chars. x 30 lines (2-byte) 12-dot standard font: 53 chars. x 40 lines (2-byte)					
Display colors	65,536 colors		256 colors	16 colors	65,536 colors	16 colors		
View angle ^{*3}	Right/left: 75°, Up: 50°, Down: 60°	GT1585V Right/left: 60°, Up: 40°, Down: 50° GT1585 Right/left: 65°, Up: 45°, Down: 55°	Right/left/up/down: 85°		Right/left: 45°, Up: 30°, Down: 20°	Right/left: 65°, Up: 20°, Down: 60°	Right/left: 45°, Up: 20°, Down: 40°	
Contrast adjustment	-							
Intensity	450 [cd/m ²]	GT1585V: 350 [cd/m ²] GT1585: 400 [cd/m ²]	400 [cd/m ²]	380 [cd/m ²]	200 [cd/m ²]	380 [cd/m ²]	150 [cd/m ²]	
Intensity adjustment	8-step adjustment		4-step adjustment		8-step adjustment		4-step adjustment	
Life	Approx. 52,000 hours (operating ambient temperature: 25°C)		Approx. 50,000 hours (operating ambient temperature: 25°C)		Approx. 41,000 hours (operating ambient temperature: 25°C)			
Backlight	Cold-cathode fluorescent tube (replaceable), with backlight OFF detection function. Backlight off time and screen save time can be set.							
Life ^{*4}	Approx. 50,000 hours or more		Approx. 40,000 hours or more		Approx. 58,000 hours or more			
	(Time for display intensity reaches 50% at operating ambient temperature of 25°C)							
Type	Analog resistive type	Matrix resistive type						
No. of touch keys	-	1900 keys/screen (38 lines x 50 columns)	1200 keys/screen (30 lines x 40 columns)					
Key size	Min. 2 x 2 [dots] (per key)	Min. 16 x 16 [dots] (per key) (16 x 8 only on lowermost line)		Min. 16 x 16 [dots] (per key)				
No. of simultaneous touch points	Simultaneous touch prohibited ^{*5} (1 point only)	Max. 2 points						
Life	1,000,000 times or more (operating force 0.98N or less) ^{*10}							
Detection distance	1 [m]	-						
Detection range	Right/left/up/down: 70°	-						
Detection delay time	0 to 4 [sec]	-						
Detection temperature	Temperature difference to be 4°C or more between human body and ambient air	-						
C drive	9MB built-in flash memory (for saving project data and OS)		5MB built-in flash memory (for saving project data and OS)	9MB built-in flash memory (for saving project data and OS)	5MB built-in flash memory (for saving project data and OS)			
Life (No. of writings)	100,000 times							
Backed up data	GT15-BAT type lithium battery (optional) Clock data and maintenance time notification data							
Life	Approx. 5 years (operating ambient temperature: 25°C)							
RS-232 ^{*8}	RS-232, 1ch Transmission speed: 115200/57600/38400/19200/9600/4800bps Connector shape: D-sub 9-pin (male) Application: Communication with connected devices, connection to personal computer (project data read/write, OS installation, FA transparent function)							
USB	USB (full-speed 12Mbps), device 1ch Connector shape: Mini-B Application: Connection to personal computer (project data read/write, OS installation, FA transparent function)							
CF card	Compact flash slot, 1ch Connector shape: TYPE I Application: Data transfer, data storage, GOT startup FAT16 format: max. 2GB, FAT32 format: not usable							
Optional function board	1ch for optional function board installation							
Extension unit ^{*9}	2ch for communication unit/optional unit installation							
Buzzer output	Single tone (tone length adjustable)							
Protective construction	Front: IP67 ^{*7} In panel: IP2X							
External dimensions (without USB port cover)	397(W) x 296(H) x 61(D) [mm]	316(W) x 242(H) x 52(D) [mm]	303(W) x 214(H) x 49(D) [mm]		241(W) x 190(H) x 52(D) [mm]			
Panel cut dimensions	383.5(W) x 282.5(H) [mm]	302(W) x 228(H) [mm]	289(W) x 200(H) [mm]		227(W) x 176(H) [mm]			
Weight (excl. mounting brackets)	5.0 [kg]	2.8 [kg]	GT1575V: 2.3 [kg] GT1575: 2.4 [kg]	2.4 [kg]	2.3 [kg]	1.9 [kg]		
Applicable software package	GT Works3 Version1.54G or later							

Power supply specifications

Item	Specification										
	GT1595-XTBA	GT1585V-STBA GT1585-STBA	GT1575V-STBA GT1575-VTBA GT1575-VNBA GT1565-VTBA GT1562-VNBA	GT1595-XTBD	GT1585V-STBD GT1585-STBD	GT1575V-STBD GT1575-VTBD GT1575-VNBD GT1565-VTBD GT1562-VNBD	GT1555-VTBD	GT1555-VTBD	GT1555-QTBD	GT1555-QSBD	GT1550-QLBD
Input power supply voltage	100 to 240VAC (+10%, -15%)					24VDC (+25%, -20%)					
Input frequency	50/60Hz ±5%										
Input maximum apparent power	110VA (at max. load)										
Power consumption	56W or less	41W or less	39W or less	57W or less (2380mA/24VDC)	43W or less (1790mA/24VDC)	41W or less (1710mA/24VDC)	19W or less (790mA/24VDC)	18W or less (750mA/24VDC)	17W or less (710mA/24VDC)	15W or less (620mA/24VDC)	
With backlight off	30W or less	28W or less	28W or less	32W or less (1330mA/24VDC)	30W or less (1250mA/24VDC)	30W or less (1250mA/24VDC)	14W or less (580mA/24VDC)	14W or less (580mA/24VDC)	13W or less (540mA/24VDC)		
Inrush current	50A or less (4ms, at max. load)	45A or less (4ms, at max. load)	40A or less (4ms, at max. load)	100A or less (4ms, at max. load)	115A or less (1ms, at max. load)	115A or less (1ms, at max. load)	67A or less (1ms, at max. load)	67A or less (1ms, at max. load)	60A or less (1ms, at max. load)		
Permissible instantaneous failure time	Within 20ms (100VAC or more)					Within 10ms					
Noise resistance	Noise voltage 1500Vp-p, noise width 1μs by noise simulator with noise frequency 25 to 60Hz					Noise voltage 500Vp-p, noise width 1μs by noise simulator with noise frequency 25 to 60Hz					
Withstand voltage	1500VAC for 1 minute between power supply terminal and ground					500VDC for 1 minute between power supply terminal and ground					
Insulation resistance	10MΩ or higher with an insulation resistance tester (500VDC between power supply terminal and ground)										
Applicable wire size	0.75 to 2 [mm ²]										
Clamp terminal	Clamp terminals for M3 screw RAV1.25-3, V2-S3.3, V2-N3A, FV2-N3A										
Tightening torque (terminal block's terminal screws)	0.5 to 0.8 [N·m]										

Performance specifications

Item	Specification			
	GT1555-VTBD	GT1555-VTBD	GT1555-QSBD	GT1550-QLBD
Type	TFT color LCD (high-brightness, wide viewing angle)		STN color LCD	STN monochrome (black/white) LCD
Screen size	5.7"			
Resolution	VGA: 640 x 480 [dots]	QVGA: 320 x 240 [dots]		
Display size	115(W) x 86(H) [mm]			
No. of displayed characters	16-dot standard font: 40 chars. x 30 lines (2-byte) 12-dot standard font: 53 chars. x 40 lines (2-byte)	16-dot standard font: 20 chars. x 15 lines (2-byte) 12-dot standard font: 26 chars. x 20 lines (2-byte)		
Display colors	65,536 colors		4,096 colors	Monochrome (black/white) 16 gray scale
View angle ^{*3}	Right/left: 80°, Up: 80°, Down: 70°	Right/left: 70°, Up: 70°, Down: 50°	Right/left: 55°, Up: 65°, Down: 70°	Right/left: 45°, Up: 20°, Down: 40°
Contrast adjustment	16-step adjustment			
Intensity	350 [cd/m ²]	400 [cd/m ²]	380 [cd/m ²]	220 [cd/m ²]
Intensity adjustment	8-step adjustment			
Life	Approx. 50,000 hours (operating ambient temperature: 25°C)			
Backlight	Cold-cathode fluorescent tube (not replaceable), with backlight OFF detection function. Backlight off time and screen save time can be set.			
Life ^{*4}	Approx. 75,000 hours or more (Time for display intensity reaches 50% at operating ambient temperature of 25°C)			
Type	Matrix resistive type			
No. of touch keys	1200 keys/screen (30 lines x 40 columns)	300 keys/screen (15 lines x 20 columns)		
Key size	Min. 16 x 16 [dots] (per key)			
No. of simultaneous touch points	Max. 2 points			
Life	1,000,000 times or more (operating force 0.98N or less)			
Detection distance	-			
Detection range	-			
Detection delay time	-			
Detection temperature	-			
C drive	9MB built-in flash memory (for saving project data and OS)			
Life (No. of writings)	100,000 times			
Backed up data	GT15-BAT type lithium battery (optional) Clock data and maintenance time notification data			
Life	Approx. 5 years (operating ambient temperature: 25°C)			
RS-232 ^{*8}	RS-232, 1ch Transmission speed: 115200/57600/38400/19200/9600/4800bps Connector shape: D-sub 9-pin (male) Application: Communication with connected devices, connection to personal computer (project data read/write, OS installation, FA transparent function)			
USB	USB (full-speed 12Mbps), device 1ch Connector shape: Mini-B Application: Connection to personal computer (project data read/write, OS installation, FA transparent function)			
CF card	Compact flash slot, 1ch Connector shape: TYPE I Application: Data transfer, data storage, GOT startup FAT16 format: max. 2GB, FAT32 format: not usable			
Optional function board	1ch for optional function board installation			
Extension unit ^{*9}	1ch for communication unit/optional unit installation			
Buzzer output	Single tone (tone length adjustable)			
Protective construction	Front: IP67 ^{*7} In panel: IP2X			
External dimensions (without USB port cover)	167(W) x 135(H) x 60(D) [mm]			
Panel cut dimensions	153(W) x 121(H) [mm]			
Weight (excl. mounting brackets)	1.1 [kg]			
Applicable software package	GT Works3 Version1.54G or later			

Component names

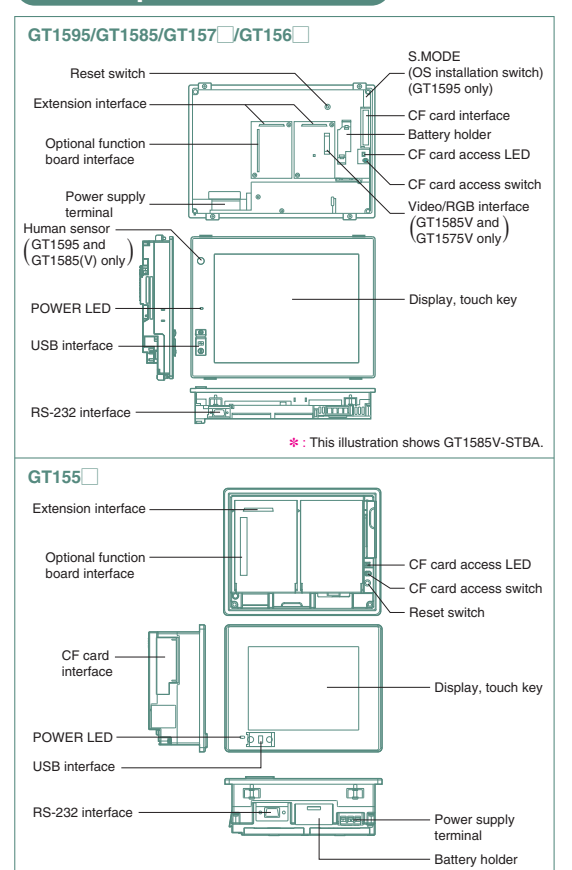

- *1: On LCD panels, bright dots (permanently lit) and black dots (never lit) generally appear. Because the number of display elements that exist on an LCD panel is large, it is not possible to reduce appearance of the bright and black dots to zero. Individual differences in LCD panels may cause differences in color, uneven brightness and flickering. Note that this is a characteristic of LCD panels and it does not mean the products are defective or damaged.
- *2: Flickering may occur depending on the display colors.
- *3: LC panels have characteristics of tone reversal. Note that even within the indicated view angles, the screen display may not be clear enough depending on the display color.
- *4: Using the GOT screen save/backlight OFF functions prevents screen burn-in and extends the backlight life.
- *5: An analog resistive touch display is used. When 2 points on the screen are touched simultaneously, if a switch is located the middle of the 2 points then the switch will be activated. Therefore, avoid touching 2 points on the screen simultaneously.
- *6: The memory is ROM that permits overwriting of new data without having to delete the existing data.
- *7: IP67 is supported when the USB environmentally protective cover is on. (The USB interface conforms to IP2X when a USB cable is connected.) However, this does not guarantee protection in all users' environments. The unit may not be used in an environment where it is exposed to splashing oil or chemicals for a long time or it is soaked with oil mist.
- *8: Where more than one extension unit, barcode reader, and RFID controller are used, the sum of their current consumptions should be within the current level which the GOT can supply. For the currents which the extension units, barcode reader, and RFID controller consume and the current level which the GOT can supply, see "Notes for use" (page 81 to page 86).
- *9: If necessary, use a stylus pen meeting the following specifications.
 - Material: Polyacetal resin
 - Pen point radius: 0.8mm or more
- *10: When using a stylus pen with GT1595-XTB, it will be 100,000 times or more (operating force 0.98N max.). Since the touch panel is a consumable product structurally, it may not be used even fewer than above, depending on the usage method and environment.

INDEX

For Designers

For Initial Startup & Operations

For Maintenance Personnel

GT10

IQ Platform

MELSEC Process Control

Specifications, External Dimensions

List of Connectable Models, etc.

Specifications, External Dimensions

Specifications, External Dimensions

Specifications

GT14

General specifications

Item	Specification
Operating ambient temperature	0°C to 50°C
Storage ambient temperature	0°C to 55°C (horizontal installation), 0°C to 50°C (vertical installation)
Operating ambient humidity ^{*1}	10 to 90%RH, no condensation
Storage ambient humidity ^{*1}	10 to 90%RH, no condensation
Vibration resistance	Conforming to JIS B 3502 and IEC 61131-2
Impact resistance	Conforming to JIS B 3502 and IEC 61131-2 (147m/s ² , 3 times each in X, Y and Z directions)
Operating atmosphere	Free from oil mist, corrosive gases, flammable gases and excessive conductive dusts or direct sun beams (The same applies to unit storage).
Operating altitude ^{*2}	2000m or less
Installation location	In control panel
Overvoltage category ^{*3}	II or lower
Contamination level ^{*4}	2 or less
Cooling method	Self-cooling
Grounding	Type D grounding (100Ω or less). Connect to panel if unable to ground.

- *1: Water bulb temperature for STN display type must be 39°C or lower.
- *2: Do not operate or store the GOT unit in pressurized environments where the pressure exceeds 0m elevation atmospheric pressure, as this could result in abnormal operation. Do not pressurize inside the control panel for air purge cleaning. The pressure could raise the surface sheet, making the touch panel difficult to operate or causing the sheet to come off.
- *3: Assuming that the device is connected at some point between a public power distribution network and local system equipment. Category II applies to devices that are supplied with power from fixed equipment. The surge withstand voltage is 2500V for devices with ratings up to 300V.
- *4: Index that indicates the level of foreign conductive matter in the operating environment of the device. Contamination level 2 denotes contamination by non-conductive matter only, though momentary conductivity may occur due to occasional condensation.

Do not use or store the GOT under direct sun light or in an environment with excessively high temperature, dust, humidity or vibration.

For inquiries relating to products which conform to UL, cUL, and CE directives and shipping directives, please contact your local sales office.

Performance specifications

Item	Specification	
	GT1455-QTBDE	GT1450-QLBDE
Type	TFT color LCD	STN monochrome (black/white) LCD
Screen size	5.7"	
Resolution	QVGA: 320 x 240 [dots]	
Display size	115(W) x 86(H) [mm] (in horizontal display mode)	
No. of displayed characters	16-dot standard font: 20 chars. x 15 lines (2-byte) (in horizontal display mode) 12-dot standard font: 26 chars. x 20 lines (2-byte) (in horizontal display mode)	
Display colors	65536 colors	Monochrome (black/white)
View angle ^{*2}	Right/left: 80°, Up: 80°, Down: 60° (in horizontal display mode)	Right/left: 45°, Up: 20°, Down: 40° (in horizontal display mode)
Contrast adjustment	32-step adjustment	
Intensity	400 [cd/m ²]	300 [cd/m ²]
Intensity adjustment	8-step adjustment	
Life	Approx. 50,000 hours (Time for display contrast reaches 20% at operating ambient temperature of 25°C) LED (not replaceable) with backlight OFF detection function. Backlight off time and screen save time can be set.	
Backlight	Life ^{*3} Approx. 75,000 hours or more (Time for display intensity reaches 50% at operating ambient temperature of 25°C)	
Touch panel	Type Analog resistive type Key size Min. 2 x 2 [dots] (per key) No. of simultaneous touch points Simultaneous touch prohibited ^{*4} (If two or more points are pressed simultaneously, the switch may function near the center of the pressed point.) Life 1,000,000 times or more (operating force 0.98N or less)	
Memory	C drive ^{*5} 9MB built-in flash memory (for saving project data and OS) Life (No. of writings) 100,000 times D drive 512KB built-in SRAM (for battery backup)	
Battery	GT11-50BAT type lithium battery Backed up data Clock data, alarm history, recipe data, time action set values, advanced alarm, advanced recipe, logging, hardcopy, SRAM user area Life Approx. 5 years (operating ambient temperature: 25°C)	
Built-in interface	RS-422/485 RS-422/485, 1ch Transmission speed: 115200/57600/38400/19200/9600/4800bps Connector shape: D-sub 9-pin (female) Application: Communication with connected devices Terminal resistance ^{*6} : OPEN/110Ω /330Ω (switching by terminal resistance transfer switch) RS-232 RS-232, 1ch Transmission speed: 115200/57600/38400/19200/9600/4800bps Connector shape: D-sub 9-pin (male) Application: Communication with connected devices, connection to barcode reader/RFID, connection to personal computer (project data read/write, OS installation, FA transparent function) Ethernet Data transfer system: 100BASE-TX, 10BASE-T, 1ch Connector shape: RJ-45 (modular jack) Application: Communication with connected devices, gateway function, connection to personal computer (project data read/write, OS installation, FA transparent function) USB USB (full-speed 12Mbps), host 1ch Connector shape: TYPE-A Application: USB mouse/keyboard connection, USB memory data transfer and storage FAT16 format: max. 2GB, FAT32 format: max. 32GB USB (full-speed 12Mbps), device 1ch Connector shape: Mini-B Application: Connection to personal computer (project data read/write, OS installation, FA transparent function) SD card Complied with SD standard, 1ch. Supported memory card: SDHC memory card, SD memory card Application: project data read/write, OS installation, logging data storage FAT16 format: max. 2GB, FAT32 format: max. 32GB	
Buzzer output	Single tone (tone length adjustable)	
Protective construction	Front: IP67 ^{*7}	
External dimensions	164(W) x 135(H) x 55(D) [mm]	
Panel cut dimensions	153(W) x 121(H) [mm]	
Weight (excl. mounting brackets)	0.7kg	
Applicable software packages	GT Works3 Version1.54G or later (not supported by GT Works2/GT Designer2)	

- *1: On LCD panels, bright dots (permanently lit) and black dots (never lit) generally appear. Because the number of display elements that exist on an LCD panel is large, it is not possible to reduce appearance of the bright and black dots to zero. Flickering may occur depending on the display colors. Note that the existence of bright and black dots is a standard characteristic of LCD panels, and it does not mean that the products are defective or damaged. Displaying one single screen for a long time can lead to burn-in, causing afterimages or image irregularities that could not disappear. Use the screen saver that is effective to prevent burn-in.
- *2: LCD panels have characteristics of tone reversal. Note that even within the indicated view angles, the screen display may not be clear enough depending on the display color.
- *3: Using the GOT screen save/backlight OFF functions prevents screen burn-in and extends the backlight life.
- *4: An analog resistive touch display is used. When 2 points on the screen are touched simultaneously, if a switch is located the middle of the 2 points then the switch will be activated. Therefore, avoid touching 2 points on the screen simultaneously.
- *5: The memory is ROM that permits overwriting of new data without having to delete the existing data.
- *6: In the case of GOT multi-drop connection, set the terminal resistance transfer switch on the GOT main unit according to the connection configuration.
- *7: This does not guarantee protection in all users' environments. The specification is not applied when the interface protective cover and rear face protective cover are removed. The unit may not be used in an environment where it is exposed to splashing oil or chemicals for a long time or soaked with oil mist.

Power supply specifications

Item	GT1455-QTBDE	GT1450-QLBDE
Input power supply voltage	24VDC (+10%, -15%), ripple voltage of 200mV or less	
Input frequency	-	
Input maximum apparent power	-	
Fuse (built-in, not replaceable)	1.6A	
Power consumption	8.40W or less (350mA/24VDC)	
With backlight off	7.44W or less (310mA/24VDC)	
Inrush current	30A or less (2ms, at max. load)	
Permissible instantaneous failure time	Within 5ms	
Noise resistance	Noise voltage 1000Vp-p, noise width 1μs by noise simulator with noise frequency 30 to 100Hz	
Withstand voltage	500VAC for 1 minute between power supply terminal and ground	
Insulation resistance	10MΩ or higher with an insulation resistance tester (500VDC between power supply terminal and ground)	
Applicable wire size	0.75 to 2 [mm ²]	
Clamp terminal	Clamp terminals for M3 screw RAV1.25-3, V2-N3A, FV2-N3A	
Tightening torque (terminal block's terminal screws)	0.5 to 0.8 [N·m]	

Component names

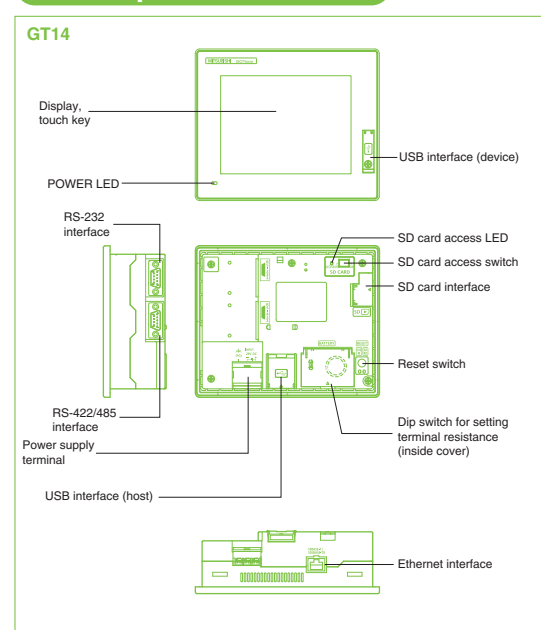

GT12

General specifications

Item	Specification
Operating ambient temperature	0°C to 50°C
Storage ambient temperature	0°C to 55°C
Operating ambient humidity	10 to 90%RH, no condensation
Storage ambient humidity	10 to 90%RH, no condensation
Vibration resistance	Conforming to JIS B 3502 and IEC 61131-2
Impact resistance	Conforming to JIS B 3502 and IEC 61131-2 (147m/s ² , 3 times each in X, Y and Z directions)
Operating atmosphere	No oily smoke, corrosive gas or combustible gas, less conductive dust, away from direct sunlight (the same in storage)
Operating altitude ^{*1}	2,000m or lower
Installation location	In control panel
Overvoltage category ^{*2}	II or lower
Contamination level ^{*3}	2 or less
Cooling method	Self-cooling
Grounding	Type D grounding (100Ω or less). Connect to panel if unable to ground.

- *1: Do not operate or store the GOT unit in pressurized environments where the pressure exceeds 0 m elevation atmospheric pressure, as this could result in abnormal operation. Do not pressurize inside the control panel for air purge cleaning. The pressure could raise the surface sheet, making the touch panel difficult to operate or causing the sheet to come off.
- *2: Assuming that the device is connected at some point between a public power distribution network and local system equipment. Category II applies to devices that are supplied with power from fixed equipment. The surge withstand voltage is 2,500V for devices with ratings up to 300V.
- *3: Index that indicates the level of foreign conductive matter in the operating environment of the device. Contamination level 2 denotes an environment contaminated only by non-conductive matter which may, under certain conditions, become temporarily conductive due to condensation.

Do not use or store the GOT under direct sun light or in an environment with excessively high temperature, dust, humidity or vibration.

For inquiries relating to products which conform to UL, cUL, and CE directives and shipping directives, please contact your local sales office.

Performance specifications

Item	Specification	
	GT1275-VNBA GT1275-VNBD	GT1265-VNBA GT1265-VNBD
Type	TFT color LCD	
Screen size	10.4"	8.4"
Resolution	VGA: 640 x 480 [dots]	
Display size	211.2(W) x 158.4(H) [mm]	170.9(W) x 128.2(H) [mm]
No. of displayed characters	16-dot standard font: 40 chars. x 30 lines (2-byte) 12-dot standard font: 53 chars. x 40 lines (2-byte)	
Display colors	256 colors	
View angle ^{*2}	Right/left: 45°, Up/down: 20°	
Intensity	200 [cd/m ²]	
Intensity adjustment	4-step adjustment	
Life	Approx. 52,000 hours (operating ambient temperature: 25°C)	
Backlight	Cold-cathode fluorescent tube (replaceable), 1CCFL light	
Life ^{*3}	50,000 hours or more (at standard lamp current = 6.0 [mA])	40,000 hours or more (at standard lamp current = 7.0 [mA]) (Time for display intensity reaches 50% at operating ambient temperature of 25°C)
Touch panel	Type Analog resistive type Key size Min. 2 x 2 [dots] (per key) No. of simultaneous touch points Simultaneous touch prohibited ^{*4} (If two or more points are pressed simultaneously, the switch may function near the center of the pressed points.) Life ^{*5} 1,000,000 times or more (operating force 0.98N or less)	
Detection distance	-	
Detection range	-	
Detection delay time	-	
Detection temperature	-	
Memory	C drive 6MB built-in flash memory (for saving project data and OS) Life (No. of writings) 100,000 times	
Battery	GT11-50BAT type lithium battery (optional) Backed up data Clock data, alarm history, and recipe data Life Approx. 5 years (operating ambient temperature: 25°C)	
Built-in interface	RS-232 ^{*6} RS-232, 1ch Transmission speed: 115200/57600/38400/19200/9600/4800bps Connector shape: D-sub 9-pin (male) Application: Communication with connected devices, connection to personal computer (project data read/write, OS installation, FA transparent function) RS-422/485 RS-422/485, 1ch Transmission speed: 115200/57600/38400/19200/9600/4800bps Connector shape: D-sub 9-pin (female) Application: Communication with connected devices Ethernet Data transfer system: 100BASE-TX, 1ch Connector shape: RJ-45 (modular jack) Application: Communication with connected devices, connection to personal computer (project data read/write, OS installation, FA transparent function) USB USB (Full Speed 12 Mbps), device 1ch Connector shape: Mini-B Application: Connection to personal computer (project data read/write, OS installation, FA transparent function) CF card Compact flash slot, 1ch Connector shape: TYPE I Application: Data transfer, data storage, GOT startup FAT16 format: max. 2GB, FAT32 format: not usable Optional function board - Extension unit ^{*6} -	
Buzzer output	Single tone (tone length adjustable)	
Protective construction	IP67 ^{*7}	
External dimensions	303(W) x 214(H) x 53(D)	241(W) x 190(H) x 58(D)
Panel cut dimensions	289(W) x 200(H) [mm]	227(W) x 176(H) [mm]
Weight (excl. mounting brackets)	2.3 [kg]	
Applicable software package	GT Works3 Version1.54G or later (not supported by GT Works2/GT Designer2)	

- *1: On LCD panels, bright dots (permanently lit) and black dots (never lit) generally appear. Because the number of display elements that exist on an LCD panel is large, it is not possible to reduce appearance of the bright and black dots to zero. Individual differences in LCD panels may cause differences in color, uneven brightness and flickering. Note that this is a characteristic of LCD panels and it does not mean the products are defective or damaged.
- *2: LCD panels have characteristics of tone reversal. Note that even within the indicated view angles, the screen display may not be clear enough depending on the display color.
- *3: Using the GOT screen save/backlight OFF functions prevents screen burn-in and extends the backlight life.
- *4: An analog resistive touch display is used. When 2 points on the screen are touched simultaneously, if a switch is located the middle of the 2 points then the switch will be activated. Therefore, avoid touching 2 points on the screen simultaneously.
- *5: The memory is a ROM that permits overwriting of new data without having to delete the existing data.
- *6: Where more than one extension unit, barcode reader, and RFID controller are used, the sum of their current consumptions should be within the current level which the GOT can supply. For the currents which the extension units, barcode reader, and RFID controller consume and the current level which the GOT can supply, see "Notes for use" (page 81).
- *7: If necessary, use a stylus pen meeting the following specifications.
 - Material: Polyacetal resin
 - Pen point radius: 0.8mm or more
- *8: When using a stylus pen, it will be 100,000 times or more (operating force 0.98N max.). Since the touch panel is a consumable product structurally, it may not be used even fewer than above, depending on the usage method and environment.

Power supply specifications

Item	Specification	
	GT1265/75-VNBA	GT1265/75-VNBD
Input power supply voltage	100 to 240VAC (+10%, -15%)	24VDC (+25%, -20%)
Input frequency	50/60Hz ±5%	-
Input maximum apparent power	44VA (at max. load)	-
Power consumption	18W or less	11W or less
With backlight off	15W or less	6W or less
Inrush current	40A or less (4ms, at max. load)	29A or less (2ms, at max. load)
Permissible instantaneous failure time	Within 20ms (100VAC or more)	Within 10ms
Noise resistance	Noise voltage 1500Vp-p, noise width 1μs by noise simulator with noise frequency 25 to 60Hz	Noise voltage 500Vp-p, noise width 1μs by noise simulator with noise frequency 25 to 60Hz
Withstand voltage ^{*1}	1500VAC for 1 minute between power supply terminal and ground	500VDC for 1 minute between power supply terminal and ground
Insulation resistance ^{*1}	10MΩ or higher with an insulation resistance tester (500VDC between power supply terminal and ground)	
Applicable wire size	0.75 to 2 [mm ²]	
Clamp terminal	Clamp terminals for M3 screw RAV1.25-3, V2-S3.3, V2-N3A, FV2-N3A	
Tightening torque (terminal block's terminal screws)	0.5 to 0.8 [N·m]	

- *1: In DC type products, the surge absorber is connected between the power supply and the ground to avoid a malfunction due to noise caused by the application of lightning surge. The values of the dielectric withstand voltage and insulation resistance are recorded when the surge absorber is not connected.

Component names

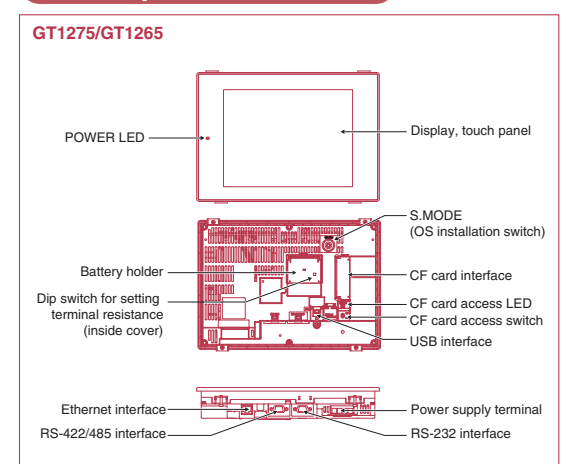

Specifications

GT11 GT10

General specifications

Item	Specification	
Operating ambient temperature	0°C to 50°C*5	
Other than display	0°C to 55°C (horizontal installation), 0°C to 50°C (vertical installation)*5	
Storage ambient temperature	-20°C to 60°C	
Operating ambient humidity*1	10 to 90%RH, no condensation	
Storage ambient humidity*1	10 to 90%RH, no condensation	
Vibration resistance	Conforming to JIS B 3502 and IEC 61131-2	
	Under intermittent vibration	Frequency: 5 to 8.4Hz, Acceleration: 8.4 to 150Hz, Half amplitude: 3.5mm, Sweep count: 10 times each in X, Y and Z directions
	Under continuous vibration	Frequency: 5 to 8.4Hz, Acceleration: 8.4 to 150Hz, Half amplitude: 1.75mm, Sweep count: -
		Frequency: 5 to 8.4Hz, Acceleration: 4.9m/s ² , Half amplitude: -
Impact resistance	Conforming to JIS B 3502 and IEC 61131-2 (147m/s ² , 3 times each in X, Y and Z directions)	
Operating atmosphere	Free from oil mist, corrosive gases, flammable gases and excessive conductive dusts or direct sun beams (The same applies to unit storage).	
Operating altitude*2	2000m or less	
Installation location	In control panel*6	
Overvoltage category*3	II or lower	
Contamination level*4	2 or less	
Cooling method	Self-cooling	
Grounding	Type D grounding (100Ω or less). Connect to panel if unable to ground.*7	

*1: Water bulb temperature for STN display type must be 39°C or lower.
 *2: Do not operate or store the GOT unit in pressurized environments where the pressure exceeds 0m elevation atmospheric pressure, as this could result in abnormal operation.
 *3: Assuming that the device is connected at some point between a public power distribution network and local system equipment. Category II applies to devices that are supplied with power from fixed equipment. The surge withstand voltage is 2500V for devices with ratings up to 300V.
 *4: Index that indicates the level of foreign conductive matter in the operating environment of the device. Contamination level 2 denotes contamination by non-conductive matter only, though momentary conductivity may occur due to occasional condensation.
 *5: 0 to 40°C for GT115□HS
 *6: Excluding GT115□HS
 *7: The 5VDC type requires no grounding.
 Do not use or store the GOT under direct sun light or in an environment with excessively high temperature, dust, humidity or vibration.
 For inquiries relating to products which conform to UL, cUL, and CE directives and shipping directives, please contact your local sales office.

Performance specifications

Item	Specification								
	GT1155-QTBD	GT1155-QSBD	GT1150-QLBD	GT1155-QTBDQ	GT1155-QSBDQ	GT1150-QLBDQ	GT1155HS-QSBD	GT1150HS-QLBD	
Type	TFT color LCD	STN color LCD	STN monochrome (black/white) LCD	TFT color LCD	STN color LCD	STN monochrome (black/white) LCD	STN color LCD	STN monochrome (black/white) LCD	
Screen size	5.7"								
Resolution	QVGA: 320 × 240 [dots]								
Display size	115(W) × 86(H) [mm] (in horizontal display mode)			115(W) × 86(H) [mm] (in horizontal display mode)			115(W) × 86(H) [mm]		
No. of displayed characters	16-dot standard font: 20 chars. × 15 lines (2-byte) 12-dot standard font: 26 chars. × 20 lines (2-byte) (in horizontal display mode)								
Display colors	256 colors		Monochrome (black/white) 16 gray scale	256 colors		Monochrome (black/white) 16 gray scale	256 colors		Monochrome (black/white) 16 gray scale
View angle	Right/left: 70°, Up: 70°, Down: 50° (in horizontal display mode)		Right/left: 45°, Up: 20°, Down: 40° (in horizontal display mode)	Right/left: 70°, Up: 70°, Down: 50° (in horizontal display mode)		Right/left: 55°, Up: 65°, Down: 70° (in horizontal display mode)	Right/left: 45°, Up: 50°, Down: 60° (Hardware versions A and B) Right/left: 55°, Up: 65°, Down: 70° (Hardware version C or later)		Right/left: 45°, Up: 20°, Down: 40°
Contrast adjustment	16-step adjustment								
Intensity	400 [cd/m ²] (Hardware versions A and B) 380 [cd/m ²] (Hardware version C or later)		220 [cd/m ²]	400 [cd/m ²]		380 [cd/m ²]	220 [cd/m ²] (Hardware versions A and B) 380 [cd/m ²] (Hardware version C or later)		220 [cd/m ²]
Intensity adjustment	8-step adjustment								
Life	Approx. 50,000 hours (operating ambient temperature: 25°C)								
Backlight	Cold-cathode fluorescent tube (not replaceable), with backlight OFF detection function. Backlight off time and screen save time can be set.								
Life*2	Approx. 75,000 hours or more		Approx. 54,000 hours or more	Approx. 75,000 hours or more		Approx. 54,000 hours or more	Approx. 75,000 hours or more		Approx. 54,000 hours or more
Touch panel	Matrix resistive type								
Type	300 keys/screen (matrix consisting of 15 lines × 20 columns)								
No. of touch keys	Min. 16 × 16 [dots] (per key)								
Key size	Max. 2 points								
No. of simultaneous touch points	1,000,000 times or more (operating force 0.98N or less)								
Life	3MB built-in flash memory (for saving project data and OS)								
C drive*3	100,000 times								
Life (No. of writings)	512KB built-in SRAM (battery backup)								
D drive	GT11-50BAT type lithium battery								
Battery	Clock data, alarm history, recipe data, time action set values								
Backed up data	Replacement guideline approx. 5 years (operating ambient temperature: 25°C)								
Life	1ch for QCPU (Q mode)/motion controller CPU (Q series) or 1ch for QnA/ACPU/motion controller CPU (A series) Application: For bus connection of PLC								
Bus	RS-422/485, 1ch Transmission speed: 115200/57600/38400/19200/9600/4800bps Connector shape: D-sub 9-pin (female) Application: Communication with PLCs Terminal resistance*5: OPEN/110Ω/330Ω (switching by terminal resistance transfer switch)								
RS-422/485	-								
Built-in interface	RS-422/232, 1ch (Select one when using.) Transmission speed: 115200/57600/38400/19200/9600/4800bps Connector shape: Round type, 32-pin (male) Application: Communication with connected devices								
RS-422/232	-								
RS-232	Transmission speed: 115200/57600/38400/19200/9600/4800bps Connector shape: D-sub 9-pin (male) Application: Communication with connected devices, connection to personal computer (project data read/write, OS installation, FA transparent function, etc.)								
USB	USB (full-speed 12Mbps), device 1ch Connector shape: Mini-B Application: Connection to personal computer (project data read/write, OS installation, FA transparent function)								
CF card	Compact flash slot, 1ch Connector shape: TYPE I Application: Data transfer, data storage, GOT startup FAT16 format: max. 2GB, FAT32 format: not usable								
Optional function board	Embedded in main unit								
Buzzer output	Single tone (tone length adjustable)								
Protective construction*4	Front: IP67 In panel: IP2X			Front: IP67 In panel: IP2X			IP65f (when external connection cable is connected)		
External dimensions (without USB port cover)	164(W) × 135(H) × 56(D) [mm]			167(W) × 135(H) × 65(D) [mm]			176(W) × 220(H) × 93(D) [mm]		
Panel cut dimensions	153(W) × 121(H) [mm]			153(W) × 121(H) [mm]			-		
Weight	0.7 [kg] (excl. mounting brackets)			0.9 [kg] (excl. mounting brackets)			1.0 [kg] (main unit only)		
Applicable software package	GT Works3 Version 1.54G or later								

Power supply specifications

Item	Specification										
	GT1155-QTBD	GT1155-QSBD	GT1155HS-QSBD	GT1150-QLBD	GT1155-QTBDQ	GT1155-QSBDQ	GT1150-QLBDQ	GT1055-QSBD	GT1050-QBBD	GT1045-QSBD	GT1040-QBBD
Input power supply voltage	24VDC (+10%, -15%), ripple voltage of 200mV or less										
Input frequency	-										
Input maximum apparent power	-										
Power consumption	9.84W or less (410mA/24VDC)	9.36W or less (390mA/24VDC)	11.16W or less (465mA/24VDC)	9.72W or less (405mA/24VDC)	7.92W or less (330mA/24VDC)	9.84W or less (410mA/24VDC)	9.36W or less (390mA/24VDC)	3.6W or less (150mA/24VDC)			
With backlight off	4.32W or less (180mA/24VDC)			5.04W or less (210mA/24VDC)			4.32W or less (180mA/24VDC)			2.9W or less (120mA/24VDC)	
Inrush current	15A or less (2ms, at max. load)			26A or less (4ms, at max. load)			15A or less (26.4V) 2ms				
Permissible instantaneous failure time	Within 5ms			Within 10ms			Within 5ms				
Noise resistance	Noise voltage 1000Vp-p, noise width 1μs by noise simulator with noise frequency 30 to 100Hz			Noise voltage 500Vp-p, noise width 1μs by noise simulator with noise frequency 25 to 60Hz			Noise voltage 1000Vp-p, noise width 1μs by noise simulator with noise frequency 30 to 100Hz				
Withstand voltage	500VAC for 1 minute between power supply terminal and ground										
Insulation resistance	10MΩ or higher with an insulation resistance tester (500VDC between power supply terminal and ground)										
Applicable wire size	0.75 to 2 [mm ²]*1									Single-wire installation: 0.14 to 1.5 [mm ²] AWG26 to AWG16 (single wire) 0.14 to 1.0 [mm ²] AWG26 to AWG16 (stranded wire) 0.25 to 0.5 [mm ²] AWG24 to AWG20 (bar terminal with insulation sleeve) Two-wire installation: 0.14 to 0.5 [mm ²] AWG26 to AWG20 (single wire) 0.14 to 0.2 [mm ²] AWG26 to AWG24 (stranded wire)	
Clamp terminal	Clamp terminals for M3 screw RAV1.25-3, V2-N3A, FV2-N3A*1										
Tightening torque (terminal block's terminal screws)	0.5 to 0.8 [N·m]*1										

*1: Excluding GT115□HS

Performance specifications

Item	Specification			
	GT1055-QSBD	GT1050-QBBD	GT1045-QSBD	GT1040-QBBD
Type	STN color LCD	STN monochrome (blue/white) LCD	STN color LCD	STN monochrome (blue/white) LCD
Screen size	5.7"			
Resolution	QVGA: 320 × 240 [dots]			
Display size	115(W) × 86(H) [mm] (in horizontal display mode)		96(W) × 72(H) [mm] (in horizontal display mode)	
No. of displayed characters	16-dot standard font: 20 chars. × 15 lines (2-byte), 12-dot standard font: 26 chars. × 20 lines (2-byte) (in horizontal display mode)			
Display colors	256 colors	Monochrome (blue/white) 16 gray scale	256 colors	Monochrome (blue/white) 16 gray scale
View angle	Right/left: 55°, Up: 65°, Down: 70° (in horizontal display mode)	Right/left: 45°, Up: 20°, Down: 40° (in horizontal display mode)	Right/left: 50°, Up: 40°, Down: 70° (in horizontal display mode)	Right/left: 45°, Up: 20°, Down: 40° (in horizontal display mode)
Contrast adjustment	16-step adjustment			
Intensity	380 [cd/m ²]	260 [cd/m ²]	150 [cd/m ²]	300 [cd/m ²]
Life	Approx. 50,000 hours (Time for display contrast reaches 20% at operating ambient temperature of 25°C)			
Backlight	Cold-cathode fluorescent tube (not replaceable) with backlight OFF detection function. Backlight off time and screen save time can be set.		LED (no need to replace) Backlight off time and screen save time can be set.	
Life*2	Approx. 75,000 hours or more	Approx. 54,000 hours or more	-	-
Touch panel	Matrix resistive type			
Type	300 keys/screen (matrix consisting of 15 lines × 20 columns)			
No. of touch keys	Min. 16 × 16 [dots] (per key)			
Key size	Max. 2 points			
No. of simultaneous touch points	1,000,000 times or more (operating force 0.98N or less)			
Life	3MB built-in flash memory for saving project data (3 MB or less) and OS			
User memory*3	100,000 times			
Life (No. of writings)	512KB built-in SRAM (battery backup) GT11-50BAT type lithium battery			
Battery	Clock data, alarm history, recipe data, time action set values			
Backed up data	Replacement guideline approx. 5 years (operating ambient temperature: 25°C)			
Life	RS-422/485, 1ch Transmission speed: 115200/57600/38400/19200/9600/4800bps Connector shape: D-sub 9-pin (female) Application: Communication with PLCs, connection with barcode readers, communication with personal computers (project data read/write, OS installation, transparent function)			
RS-422/485	-			
Built-in interface	USB (full-speed 12Mbps), device 1ch Connector shape: Mini-B Application: Communication with personal computer (project data read/write, OS installation, transparent function)			
USB	-			
Memory board	For installing memory board (GT10-50FMB) 1ch			
Buzzer output	Single tone (tone length adjustable/none)			
Protective construction*4	Conforming to IP67f (front panel)			
External dimensions	164(W) × 135(H) × 56(D) [mm]		139(W) × 112(H) × 41(D) [mm]	
Panel cut dimensions	153(W) × 121(H) [mm]		130(+1 -0)(W) × 103(+1 -0)(H) [mm]	
Weight (excl. mounting brackets)	0.7 [kg]		0.45 [kg]	
Applicable software package	GT Works3 Version 1.54G or later			

*1: On LCD panels, bright dots (permanently lit) and black dots (never lit) generally appear. Because the number of display elements that exist on an LCD panel is large, it is not possible to reduce appearance of the bright and black dots to zero. Flickering may occur depending on the display colors. Note that the existence of bright and black dots is a standard characteristic of LCD panels, and it does not mean that the products are defective or damaged. Displaying one single screen for a long time can lead to burn-in, causing afterimages or image irregularities that could not disappear. Use the screen saver that is effective to prevent burn-in.
 *2: Using the GOT screen save/backlight OFF functions prevents screen burn-in and extends the backlight life.
 *3: The memory is ROM that permits overwriting of new data without having to delete the existing data.
 *4: This does not guarantee protection in all users' environments. The specification is not applied when the interface protective cover and rear face protective cover are removed. The unit may not be used in an environment where it is exposed to splashing oil or chemicals for a long time or it is soaked with oil mist.
 *5: In the case of GOT multi-drop connection, set the terminal resistance transfer switch on the GOT main unit according to the connection configuration.

Component names

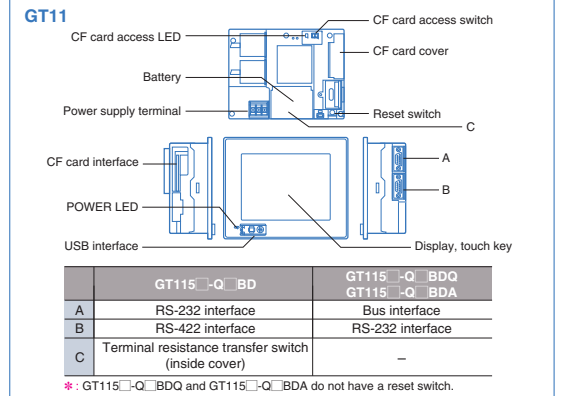

GT115□HS (Handy)

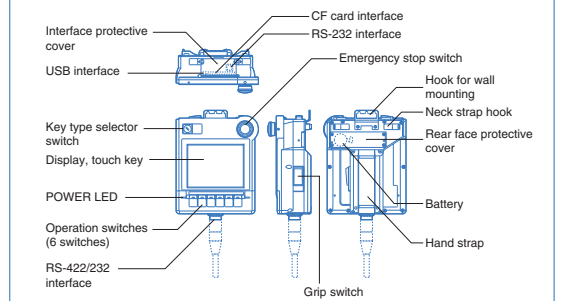

GT105□

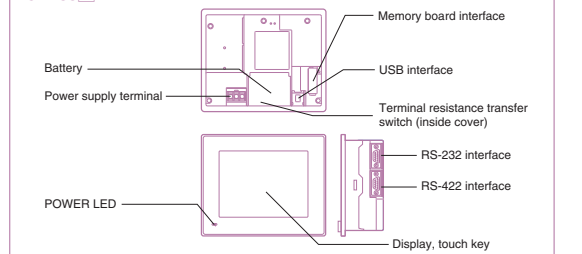

GT104□

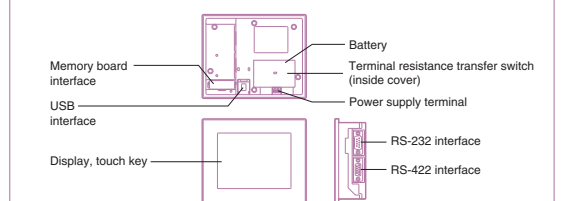

GT10

Power supply specifications

Item	Specification					
	GT1030-HBD GT1030-HWD GT1030-HBD2 GT1030-HWD2	GT1030-HBDW GT1030-HWDW GT1030-HBDW2 GT1030-HWDW2	GT1020-LBD GT1020-LWD GT1020-LBD2 GT1020-LWD2	GT1020-LBDW GT1020-LWDW GT1020-LBDW2 GT1020-LWDW2	GT1030-HBL GT1030-HWL GT1030-HBLW GT1030-HWLW	GT1020-LBL GT1020-LWL GT1020-LBLW GT1020-LWLW
Input power supply voltage	24VDC (+10%, -15%), ripple voltage of 200mV or less					
Input frequency	-					
Input maximum apparent power	-					
Power consumption	2.2W or less (90mA/24VDC)		1.9W or less (80mA/24VDC)		1.1W or less (220mA/5VDC)	
With backlight off	1.7W or less (70mA/24VDC)		1.2W or less (50mA/24VDC)		0.6W or less (120mA/5VDC)	
Inrush current	18A or less (26.4DCV) 1ms		13A or less (26.4DCV) 1ms		-	
Permissible instantaneous failure time	Within 5ms					
Noise resistance	Noise voltage 1000Vp-p, noise width 1μs by noise simulator with noise frequency 30 to 100Hz					
Withstand voltage	500VAC for 1 minute between power supply terminal and ground					
Insulation resistance	10MΩ or higher with an insulation resistance tester (500VDC between power supply terminal and ground)					
Applicable wire size	Single-wire installation: 0.14 to 1.5mm ² , AWG26 to AWG16 (single wire), 0.14 to 1.0mm ² , AWG26 to AWG16 (stranded wire), 0.25 to 0.5mm ² , AWG24 to AWG20 (bar terminal with insulation sleeve) Two-wire installation: 0.14 to 0.5mm ² , AWG26 to AWG20 (single wire), 0.14 to 0.2mm ² , AWG26 to AWG24 (stranded wire)					
Clamp terminal	AI2.5-6BU, AI0.34-6TQ, AI0.5-6WH (made by Phoenix Contact)					
Tightening torque (terminal block's terminal screws)	0.22 to 0.25 [N·m]					

Do not use or store the GOT under direct sun light or in an environment with excessively high temperature, dust, humidity or vibration.

For inquiries relating to products which conform to UL, cUL, and CE directives and shipping directives, please contact your local sales office.

Performance specifications

Item	Specification								
	GT1030-HBD GT1030-HWD GT1030-HBL GT1030-HWL	GT1030-HBDW GT1030-HWDW GT1030-HBLW GT1030-HWLW	GT1030-HBD2 GT1030-HWD2	GT1030-HBDW2 GT1030-HWDW2	GT1020-LBD GT1020-LWD GT1020-LBL GT1020-LWL	GT1020-LBDW GT1020-LWDW GT1020-LBLW GT1020-LLDW	GT1020-LBD2 GT1020-LWD2	GT1020-LBDW2 GT1020-LLDW2	
Display*	Type	STN monochrome (black/white) LCD							
	Screen size	4.5"				3.7"			
	Resolution	288 × 96 [dots] (in horizontal mode)				160 × 64 [dots] (in horizontal mode)			
	Display size	109.42(W) × 35.98(H)[mm](in horizontal mode)				86.4(W) × 34.5(H)[mm](in horizontal mode)			
	No. of displayed characters	16-dot standard font: 36 chars. × 6 lines (1-byte) or 18 chars. × 6 lines (2-byte) (in horizontal mode) 12-dot standard font: 48 chars. × 8 lines (1-byte) or 24 chars. × 8 lines (2-byte) (in horizontal mode)				16-dot standard font: 20 chars. × 4 lines (1-byte) or 10 chars. × 4 lines (2-byte) (in horizontal mode)			
	Display colors	Monochrome (black/white)							
	View angle	Right/left: 30°, Up: 20°, Down: 30° (in horizontal display mode)							
	Contrast adjustment	16-step adjustment							
	Intensity	200 [cd/m ²] (in green)	500 [cd/m ²] (in white)	200 [cd/m ²] (in green)	500 [cd/m ²] (in white)	200 [cd/m ²] (in green)	300 [cd/m ²] (in white)	200 [cd/m ²] (in green)	300 [cd/m ²] (in white)
	Intensity adjustment	8-step adjustment							
Backlight	Life	Approx. 50,000 hours (Time for display contrast reaches 20% at operating ambient temperature of 25°C)							
	Color	3-color LED (green, orange and red) (no need to replace)	3-color LED (white, pink and red) (no need to replace)	3-color LED (green, orange and red) (no need to replace)	3-color LED (white, pink and red) (no need to replace)	3-color LED (green, orange and red) (no need to replace)	3-color LED (white, pink and red) (no need to replace)	3-color LED (green, orange and red) (no need to replace)	3-color LED (white, pink and red) (no need to replace)
	Function	Status control (color, on/flashing/off) is available and screen save time setting can be set. PLC can control color and status of backlight based on system information.							
	Type	Matrix resistive type				Analog resistive type			
	No. of touch keys	Max. 50 keys/screen				-			
Touch panel	Key size	Min. 16 × 16 [dots] (per key)				Min. 2 × 2 [dots] (per key)			
	No. of simultaneous touch points	Max. 2 points				Impossible (If there is a switch near the center of the pressed keys, the switch may function.)			
	Life	1,000,000 times or more (operating force 0.98N or less)							
Memory	User memory**	Built-in flash memory for saving project data (1.5MB or less) and OS				Built-in flash memory for saving project data (512KB or less), OS, alarm history, recipe data, time action set values			
	Life (No. of writings)	100,000 times							
Battery	Backed up data	GT11-50BAT type lithium battery							
	Life	Clock data, alarm history, recipe data, time action set values Replacement guideline approx. 5 years (operating ambient temperature: 25°C)							
Built-in interface	For communication with PLC	GT1030-HBD/HWD, GT1030-HBDW/HWDW RS-422/485, 1ch Transmission speed: 115200/57600/38400/19200/9600/4800bps Connector shape: Connector terminal block, 9-pin Application: Communication with PLC Terminal resistance*3: OPEN/110Ω/330Ω (switched by terminal resistance transfer switch)		RS-232, 1ch Transmission speed: 115200/57600/38400/19200/9600/4800bps Connector shape: Connector terminal block, 9-pin Application: Communication with PLC		GT1020-LBD/LWD, GT1020-LBDW/LWDW RS-422/485, 1ch Transmission speed: 115200/57600/38400/19200/9600/4800bps Connector shape: Connector terminal block, 9-pin Application: Communication with PLC Terminal resistance*3: OPEN/110Ω/330Ω (switched by terminal resistance transfer switch)		RS-232, 1ch Transmission speed: 115200/57600/38400/19200/9600/4800bps Connector shape: Connector terminal block, 9-pin Application: Communication with PLC	
	For communication with personal computer	GT1030-HBL/HWL, GT1030-HBLW/HWLW RS-422, 1ch Transmission speed: 115200/57600/38400/19200/9600/4800bps Connector shape: Connector terminal block, 9-pin Application: Communication with PLC		GT1020-LBL/LWL, GT1020-LBLW/LWLW RS-422, 1ch Transmission speed: 115200/57600/38400/19200/9600/4800bps Connector shape: Connector terminal block, 9-pin Application: Communication with PLC		RS-232, 1ch Transmission speed: 115200/57600/38400/19200/9600/4800bps Connector shape: Mini DIN 6-pin (female) Application: Communication with personal computer (project data read/write, OS installation, transparent function)			
	Buzzer output	Single tone (tone length adjustable/none)							
	Protective construction**	Conforming to IP67 (front panel)							
External dimensions	145(W) × 76(H) × 29.5(D)[mm]				113(W) × 74(H) × 27(D)[mm]				
Panel cut dimensions	137(W) × 66(H)[mm]				105(W) × 66(H)[mm]				
Weight	GT1030-H□□(W): 0.3kg (excl. mounting brackets) GT1030-H□□(L): 0.28kg (excl. mounting brackets)		0.3kg (excl. mounting brackets)		GT1020-L□□(W): 0.2kg (excl. mounting brackets) GT1020-L□□(L): 0.18kg (excl. mounting brackets)		0.2kg (excl. mounting brackets)		
Applicable software packages	GT Works3 Version1.54G or later (not supported GT Works2/GT Designer 2)				GT Works3 Version1.54G or later				

- *1: On LCD panels, bright dots (permanently lit) and black dots (never lit) generally appear. Because the number of display elements that exist on a LCD panel is large, it is not possible to reduce appearance of the bright and black dots to zero. Flickering may occur depending on the display colors. Note that the existence of bright and black dots is a standard characteristic of LCD panels, and it does not mean that the products are defective or damaged. Displaying one single screen for a long time can lead to burn-in, causing afterimages or image irregularities that could not disappear. Use the screen saver that is effective to prevent burn-in.
- *2: The memory is ROM that permits overwriting of new data without having to delete the existing data.
- *3: In the case of GOT multi-drop connection, set the terminal resistance transfer switch on the GOT main unit according to the connection configuration.
- *4: This does not guarantee protection in all users' environments. The specification is not applied when the interface protective cover and rear face protective cover are removed. The unit may not be used in an environment where it is exposed to splashing oil or chemicals for a long time or it is soaked with oil mist.

GOT main units

External dimensions

(Unit: mm)

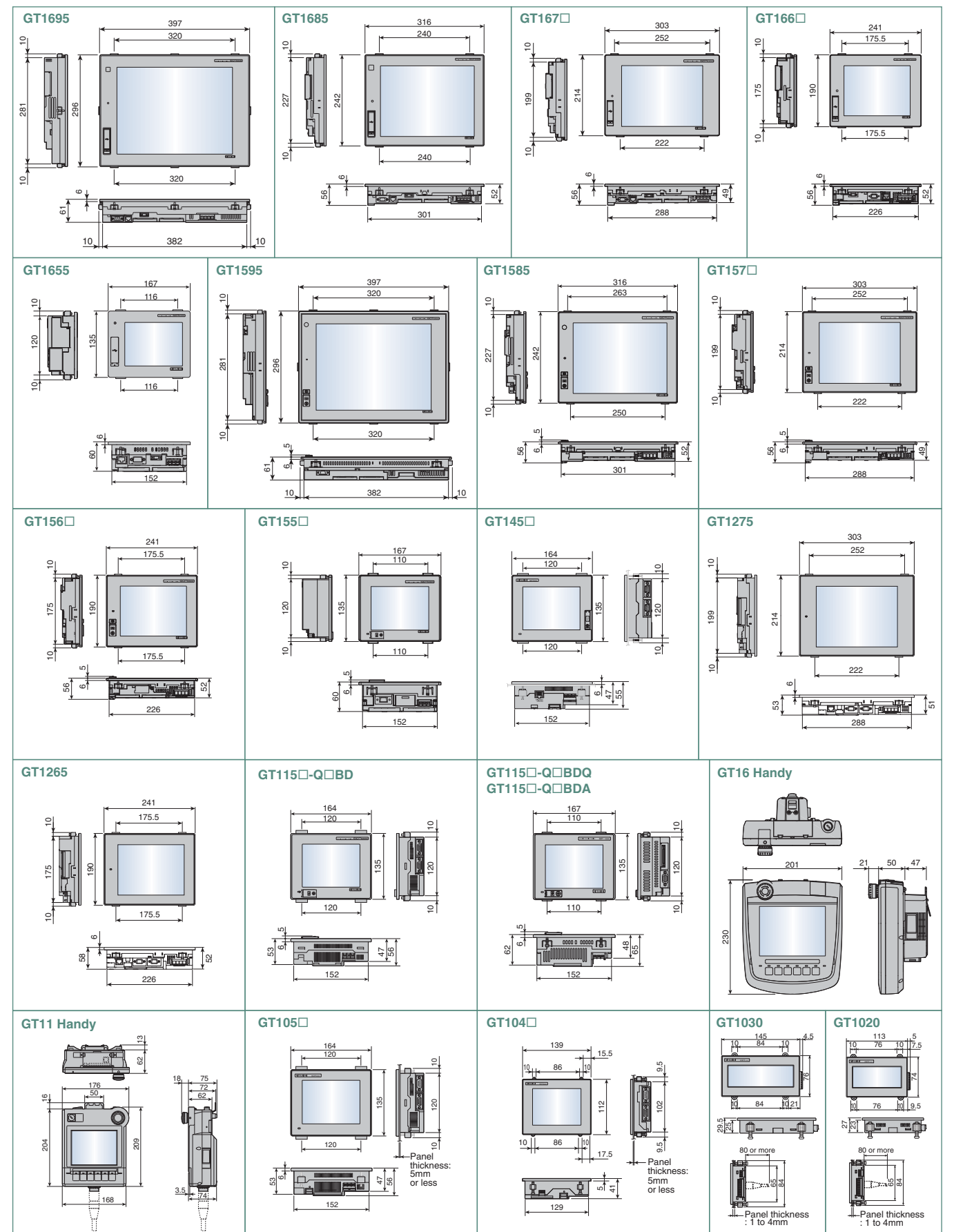

INDEX

For Designers

For Initial Startup & Operations

For Maintenance Personnel

GT10

IQ Platform

MEI-SEC Process Control

Specifications, External Dimensions

List of Connectable Models, etc.

External dimensions

Panel cut dimensions

When the GOT is installed

Screen size	Type of GOT main unit	A	B
15"	GT1695	383.5	282.5
	GT1595		
12.1"	GT1685 ^{*1}	302	228
	GT1585 ^{*1}		
10.4"	GT167 ^{*2}	289	200
	GT157 ^{*2}		
8.4"	GT1275	227	176
	GT166		
5.7"	GT1655 ^{*3}	153	121
	GT155 ^{*3}		
4.7"	GT145 ^{*3}	130	103
	GT115 ^{*3}		
4.5"	GT105 ^{*3}	137	66
3.7"	GT104	105	66

- *1: Same dimensions as A985GOT(-V)
- *2: Same dimensions as A975/970GOT(-B)
- *3: Same dimensions as F940GOT
- *4: For the GT104, GT1030 and GT1020, the tolerances are +1/0.

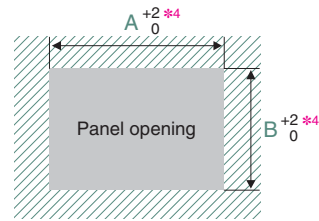

When the CF card extension unit (mounting unit on control panel) is installed

Type	A	B
GT15-CFEX-C08SET	94.0	33.0

Cautions when installing and uninstalling
 When installing the CF card extension unit on the control panel, make sure that the extension unit does not interfere with the extension unit cable or the CF card interface of the GOT. Place the CF card extension unit at a distance of 25mm or more from the GOT.
 For installation locations, see the GT16 User's Manual (Hardware) or the GT15 User's Manual.

For compatibility with GOT900 series, see "Backward compatibility" (page 81).

Product installation spacing

The GOT must have the clearances from other devices as shown in [Fig. A]. The GOT may require more distance than the dimensions shown in the table depending on the types of connection cables. Consider the connector dimensions and cable bending radius when designing the installation.

GT16/GT15

Item	GT1695	GT1685	GT167	GT166	GT1655	GT1595	GT1585	GT157	GT156	GT155
GOT only	50 or more (20 or more)	50 or more (24 or more)	50 or more (26 or more)	50 or more (36 or more)	61 or more	50 or more (20 or more)	50 or more (20 or more)	50 or more (35 or more)	50 or more (21 or more)	49 or more
When a bus connection unit is installed	50 or more (20 or more)	50 or more (24 or more)	50 or more (26 or more)	50 or more (36 or more)	50 or more	50 or more (20 or more)	50 or more (20 or more)	50 or more (35 or more)	50 or more (21 or more)	50 or more
When a serial communication unit is installed	50 or more (20 or more)	50 or more (24 or more)	50 or more (26 or more)	50 or more (36 or more)	49 or more	50 or more (20 or more)	50 or more (20 or more)	50 or more (35 or more)	50 or more (21 or more)	49 or more
When a RS-422 conversion unit is installed	50 or more	51 or more	63 or more	73 or more	-	50 or more (20 or more)	50 or more (20 or more)	53 or more	58 or more	-
When an Ethernet communication unit is installed	50 or more (20 or more)									
When the CC-Link communication unit (GT15-J61B113) is installed	50 or more (20 or more)									
When a MELSECNET/H communication unit (coaxial) is installed	50 or more (20 or more)	50 or more (24 or more)	50 or more (26 or more)	50 or more	64 or more	50 or more (20 or more)	50 or more (20 or more)	50 or more (35 or more)	50 or more (21 or more)	64 or more
When a MELSECNET/H communication unit (optical) is installed	50 or more (20 or more)									
When a CC-link IE Controller Network communication unit is installed	50 or more (20 or more)									
When a CC-link IE Field Network communication unit is installed	50 or more (20 or more)									
When a printer unit is installed	50 or more (20 or more)	50 or more (24 or more)	50 or more (26 or more)	50 or more (36 or more)	50 or more (29 or more)	50 or more (20 or more)	50 or more (20 or more)	50 or more (35 or more)	50 or more (21 or more)	50 or more (28 or more)
When a multimedia unit is installed	50 or more (20 or more)									
When a video input unit is installed	50 or more (20 or more)									
When a RGB input unit is installed	50 or more (20 or more)									
When a video/RGB input unit is installed	50 or more (20 or more)									
When a RGB output unit is installed	50 or more (20 or more)									
When a CF card unit is installed	50 or more (20 or more)	50 or more (24 or more)	50 or more (26 or more)	50 or more (36 or more)	50 or more (20 or more)	50 or more (20 or more)	50 or more (20 or more)	50 or more (35 or more)	50 or more (21 or more)	50 or more (28 or more)
When a CF card extension unit is installed	50 or more (20 or more)	50 or more (24 or more)	50 or more (26 or more)	50 or more (36 or more)	50 or more	50 or more (20 or more)	50 or more (20 or more)	63 or more	68 or more	97 or more
When an audio output unit is installed	50 or more (20 or more)									
When an external input/output unit is installed	50 or more (20 or more)									
B (When a CF card is not used)	50 or more (20 or more)									
C (When a CF card is used)	50 or more (20 or more)									
D	50 or more (20 or more)									
E	100 or more (20 or more)									

- *1: The distance varies depending on the cable to be used. For details, consult your local sales office. The values in the table are given for your reference only and may not reflect actual conditions.
- *2: The distances required when the coaxial cable 3C-2V (JIS C 3501) is used.
- *3: The distance varies depending on the cable used. When the bending radius of the cable is larger than the indicated value, leave enough space appropriate for the bending radius.
- *4: When using a battery, the required dimension is greater than when using a CF card.

GT14

GOT main unit	A, D	B	C	E
GT1455	50 or more ^{*3}	80 or more ^{*1}	50 or more ^{*2}	100 or more ^{*4}
GT1450	(20 or more)	(20 or more)	(20 or more)	(20 or more)

- *1: 50 or more (20 or more) in the case of vertical installation
- *2: 80 or more (20 or more) in the case of vertical installation
- *3: The distance varies depending on the Ethernet cable used. When the bending radius of the Ethernet cable is larger than the indicated value, leave enough space appropriate for the bending radius.
- *4: When using a USB memory or SD card, allow space for removal and mounting when installing.

GT12

GOT main unit	A, D	B	C		E
			When CF card is not used	When CF card is used	
GT1275	50 or more	80 or more	50 or more	50 or more	100 or more
GT1265				100 or more	

GT11

GOT main unit	A, D	B	C		E
			When CF card is not used	When CF card is used	
GT1155	50 or more	80 or more ^{*1}	50 or more ^{*2}	100 or more	100 or more
GT1150	(20 or more)	(20 or more)	(20 or more)	(20 or more)	(20 or more)

- *1: 50 or more (20 or more) in the case of vertical installation
- *2: 80 or more (20 or more) in the case of vertical installation

GT10

GOT main unit	A	B	C	D	E
GT105	50 or more	80 or more	50 or more	50 or more	100 or more
GT104	(20 or more)	(20 or more)	(20 or more)	(20 or more)	(20 or more ^{*3})
GT1030	50 or more	50 or more	50 or more	50 or more	80 or more
GT1020	(20 or more ^{*1})	(20 or more)	(20 or more)	(20 or more)	(20 or more ^{*2})

- *1: 50 or more when a RS-232/USB conversion adapter is used.
- *2: 80 or more when a personal computer connection cable is used or when a personal computer RS-232 interface is used for connecting multiple GOTs.
- *3: 50 or more when a RS-232 interface is used for using an RS-232/USB conversion adapter.
- *4: 80 or more when using a USB cable or a memory board.

[Fig. A]

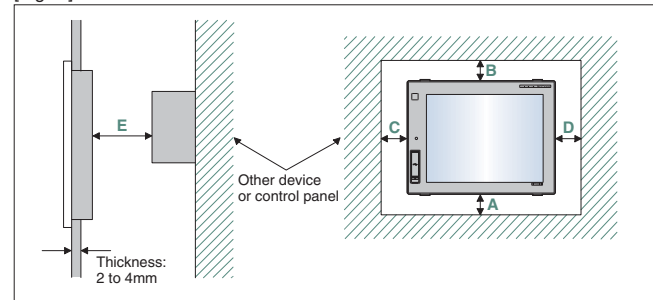

Dimensions shown in parentheses apply when there are no devices nearby (contactor, etc.) which produce radiated noise or heat. Even with these dimensions, however, the ambient temperature must never exceed 55°C.
 Depending on the unit and cable being used, a cable length longer than dimension A (or dimension D for the GT10) in above [Fig. A] may be required.

Bus connection cables

Cable model name	Cable length (L)	External dimensions
GT15-QC-B	0.6, 1.2, 3, 5, 10m	Fig. 1
GT15-QC-BS	15, 20, 25, 30, 35m	Fig. 1
GT15-C-B	1.2, 3, 5m	Fig. 2
GT15-AC-B	0.6, 1.2, 3, 5m	Fig. 3
GT15-A370C-B-S1	1.2, 2.5m	Fig. 4
GT15-A370C-B	1.2, 2.5m	Fig. 5
GT15-A1SC-B	0.7, 1.2, 3, 5m	Fig. 6
GT15-A1SC-NB	0.45, 0.7, 3, 5m	Fig. 7
GT15-C-EXSS-1 ^{*1}	10.6, 20.6, 30.6m	Figs. 8 & 9
GT15-EXCNB	0.5m	Fig. 8
GT15-C-BS	0.7, 1.2, 3, 5, 10, 20, 30m	Fig. 9
GT15-J2C10B	1m	Fig. 10

- *1: GT15-C-EXSS-1 is a set consisting of GT15-EXCNB and GT15-C-BS. (See Fig. A.)

[Fig. A]

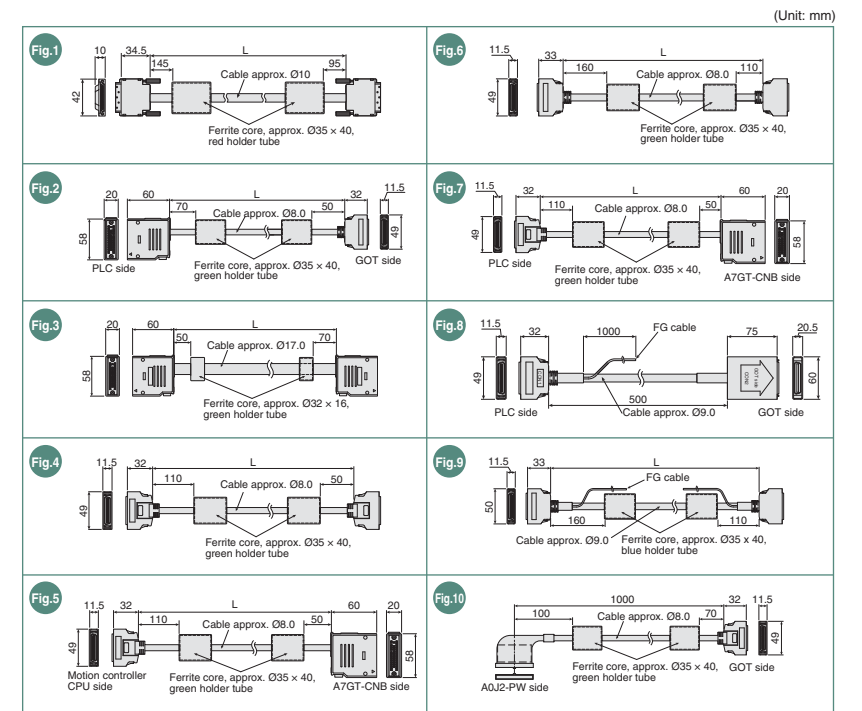
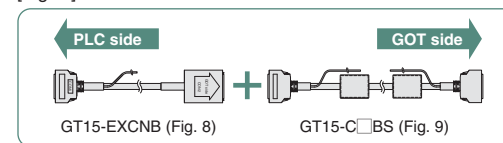

RS-422 cables

Cable model name	Cable length (L)	External dimensions
GT16-C02R4-9S	0.2m	Fig. 11
GT01-C30R4-25P	3m	Fig. 12
GT01-C-R4-25P	10, 20, 30m	Fig. 13
GT01-C-R4-8P	1, 3, 10, 20, 30m	Fig. 14
GT10-C-R4-8P	1, 3, 10, 20, 30m	Fig. 15
GT10-C-R4-25P	3, 10, 20, 30m	Fig. 16
GT10-C10R4-8PL	1m	Fig. 17
GT10-C02H-9SC	0.2m	Fig. 18

RS-232 cables

Cable model name	Cable length (L)	External dimensions
GT01-C30R2-6P	3m	Fig. 19
GT01-C30R2-9S	3m	Fig. 20
GT01-C30R2-25P	3m	Fig. 21
GT10-C30R2-6P	3m	Fig. 22

RS-485 terminal block conversion unit

Model name	Cable length (L)	External dimensions
FA-LTBGTR4CBL	0.5, 1, 2m	Fig. 23

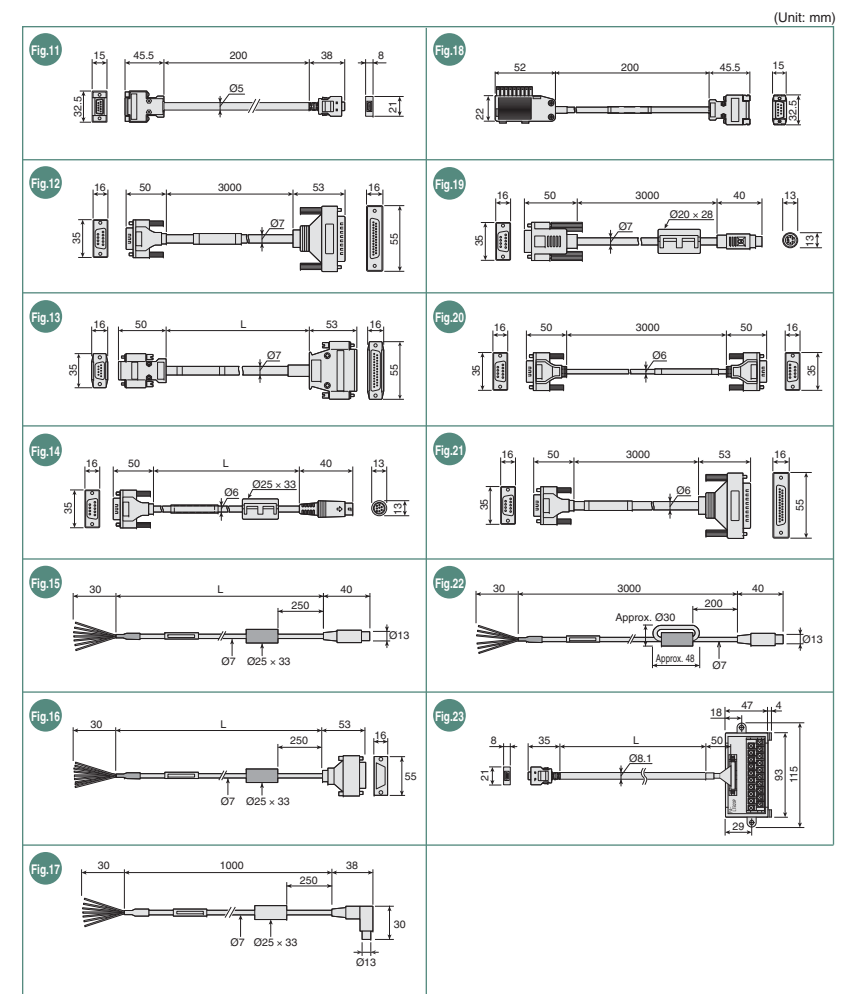

INDEX

For Designers

For Initial Startup & Operations

For Maintenance Personnel

GT10

IQ Platform

MELSEC Process Control

Specifications, External Dimensions

List of Connectable Models, etc.

Function list

GT16 GT15 GT14 GT12 GT SoftGOT

Category	Function*	Optional function board	Extended/optional function OS installation	Other necessary devices	Details page	Model																					
						GT16					GT15					GT14	GT12		GT SoftGOT 1000 Version3								
Connection configuration						GT1695M	GT1685M	GT1675M	GT1675M	GT167	GT1665M	GT1665M	GT1662	GT1655	GT1665	GT1595	GT1585(V)	GT1575(V)	GT1575	GT157	GT1565	GT1562	GT155	GT145	GT1275	GT1265	GT SoftGOT 1000 Version3
						XGA 15"	SVGA 12.1"	SVGA 10.4"	SVGA 10.4"	SVGA 10.4"	SVGA 8.4"	SVGA 8.4"	SVGA 8.4"	VGA 5.7"	HS-VTBD 6.5"	XGA 15"	SVGA 12.1"	SVGA 10.4"	SVGA 10.4"	SVGA 10.4"	SVGA 8.4"	SVGA 8.4"	SVGA 8.4"	SVGA 8.4"	SVGA 8.4"	SVGA 5.7"	QVGA 5.7"
Connection configuration	Mitsubishi PLC bus connection					●	●	●	●	●	●	●	●	●	●	●	●	●	●	●	●	●	●	●	●	●	●
	Mitsubishi PLC CPU direct connection					●	●	●	●	●	●	●	●	●	●	●	●	●	●	●	●	●	●	●	●	●	●
	Mitsubishi PLC computer link connection					●	●	●	●	●	●	●	●	●	●	●	●	●	●	●	●	●	●	●	●	●	●
	Mitsubishi PLC MELSECNET/H connection					●	●	●	●	●	●	●	●	●	●	●	●	●	●	●	●	●	●	●	●	●	●
	Mitsubishi PLC MELSECNET/10 connection					●	●	●	●	●	●	●	●	●	●	●	●	●	●	●	●	●	●	●	●	●	●
	Mitsubishi PLC CC-Link IE Controller Network connection					●	●	●	●	●	●	●	●	●	●	●	●	●	●	●	●	●	●	●	●	●	●
	Mitsubishi PLC CC-Link IE Field Network connection					●	●	●	●	●	●	●	●	●	●	●	●	●	●	●	●	●	●	●	●	●	●
	Mitsubishi PLC CC-Link connection (ID station/via G4)					●	●	●	●	●	●	●	●	●	●	●	●	●	●	●	●	●	●	●	●	●	●
	Mitsubishi PLC Ethernet connection				*10	P.65	●	●	●	●	●	●	●	●	●	●	●	●	●	●	●	●	●	●	●	●	●
	Third party PLC connection						●	●	●	●	●	●	●	●	●	●	●	●	●	●	●	●	●	●	●	●	●
	Microcomputer connection						●	●	●	●	●	●	●	●	●	●	●	●	●	●	●	●	●	●	●	●	●
	MODBUS®/RTU connection						●	●	●	●	●	●	●	●	●	●	●	●	●	●	●	●	●	●	●	●	●
	MODBUS®/TCP connection						●	●	●	●	●	●	●	●	●	●	●	●	●	●	●	●	●	●	●	●	●
	Temperature controller connection						●	●	●	●	●	●	●	●	●	●	●	●	●	●	●	●	●	●	●	●	●
	Inverter connection						●	●	●	●	●	●	●	●	●	●	●	●	●	●	●	●	●	●	●	●	●
Servo amplifier connection						●	●	●	●	●	●	●	●	●	●	●	●	●	●	●	●	●	●	●	●	●	
CNC connection						●	●	●	●	●	●	●	●	●	●	●	●	●	●	●	●	●	●	●	●	●	
Robot controller connection						●	●	●	●	●	●	●	●	●	●	●	●	●	●	●	●	●	●	●	●	●	
GOT multi-drop connection						●	●	●	●	●	●	●	●	●	●	●	●	●	●	●	●	●	●	●	●	●	
Multiple-GT14, GT12, GT11, GT10 connection#14					*10	P.49	●	●	●	●	●	●	●	●	●	●	●	●	●	●	●	●	●	●	●	●	
Hardware specifications	Standard memory capacity					15MB	15MB	15MB	15MB	11MB	15MB	15MB	11MB	15MB	15MB	9MB	9MB	9MB	5MB	9MB	5MB	9MB	9MB	9MB	6MB	6MB	57MB
	Total memory capacity when using optional memory (standard + optional)	Required#2 (GT15 only)		Memory card	P.52-	Up to 57MB	Up to 57MB	Up to 57MB	Up to 57MB	Up to 53MB	Up to 57MB	Up to 57MB	Up to 53MB	Up to 57MB	Up to 57MB	Up to 57MB	Up to 57MB	Up to 53MB	Up to 57MB	Up to 53MB	Up to 57MB	Up to 57MB	Up to 57MB	Up to 57MB	Up to 57MB	Up to 57MB	
	65,536 colors					●	●	●	●	●	●	●	●	●	●	●	●	●	●	●	●	●	●	●	●	●	●
	4,096 colors					●	●	●	●	●	●	●	●	●	●	●	●	●	●	●	●	●	●	●	●	●	●
	256 colors					●	●	●	●	●	●	●	●	●	●	●	●	●	●	●	●	●	●	●	●	●	●
	16 colors					●	●	●	●	●	●	●	●	●	●	●	●	●	●	●	●	●	●	●	●	●	●
	Monochrome (black/white) 16 gray scales					●	●	●	●	●	●	●	●	●	●	●	●	●	●	●	●	●	●	●	●	●	●
	Monochrome (black/white) 2 colors					●	●	●	●	●	●	●	●	●	●	●	●	●	●	●	●	●	●	●	●	●	●
	Monochrome (blue/white) 16 gray scales					●	●	●	●	●	●	●	●	●	●	●	●	●	●	●	●	●	●	●	●	●	●
	1920 x 1200 dots (WUXGA) (max. at specified resolution)						●	●	●	●	●	●	●	●	●	●	●	●	●	●	●	●	●	●	●	●	●
	1600 x 1200 dots (UXGA)						●	●	●	●	●	●	●	●	●	●	●	●	●	●	●	●	●	●	●	●	●
	1280 x 1024 dots (SXGA)						●	●	●	●	●	●	●	●	●	●	●	●	●	●	●	●	●	●	●	●	●
	1024 x 768 dots (XGA)						●	●	●	●	●	●	●	●	●	●	●	●	●	●	●	●	●	●	●	●	●
	800 x 600 dots (SVGA)						●	●	●	●	●	●	●	●	●	●	●	●	●	●	●	●	●	●	●	●	●
	640 x 480 dots (VGA)						●	●	●	●	●	●	●	●	●	●	●	●	●	●	●	●	●	●	●	●	●
320 x 240 dots (QVGA)						●	●	●	●	●	●	●	●	●	●	●	●	●	●	●	●	●	●	●	●	●	
288 x 96 dots						●	●	●	●	●	●	●	●	●	●	●	●	●	●	●	●	●	●	●	●	●	
160 x 64 dots						●	●	●	●	●	●	●	●	●	●	●	●	●	●	●	●	●	●	●	●	●	
RS-232 interface						●	●	●	●	●	●	●	●	●	●	●	●	●	●	●	●	●	●	●	●	●	
RS-422 interface						*5	*5	*5	*5	*5	*5	*5	*5	*5	*5	*5	*5	*5	*5	*5	*5	*5	*5	*5	*5	*5	
RS-422/232 interface						●	●	●	●	●	●	●	●	●	●	●	●	●	●	●	●	●	●	●	●	●	
RS-422/485 interface						●	●	●	●	●	●	●	●	●	●	●	●	●	●	●	●	●	●	●	●	●	
Bus interface						●	●	●	●	●	●	●	●	●	●	●	●	●	●	●	●	●	●	●	●	●	
Ethernet interface						●	●	●	●	●	●	●	●	●	●	●	●	●	●	●	●	●	●	●	●	●	
USB interface	USB host					●	●	●	●	●	●	●	●	●	●	●	●	●	●	●	●	●	●	●	●	●	
	USB device					●	●	●	●	●	●	●	●	●	●	●	●	●	●	●	●	●	●	●	●	●	
CF card interface						●	●	●	●	●	●	●	●	●	●	●	●	●	●	●	●	●	●	●	●	●	
SD card interface						●	●	●	●	●	●	●	●	●	●	●	●	●	●	●	●	●	●	●	●	●	
Optional function board interface						●	●	●	●	●	●	●	●	●	●	●	●	●	●	●	●	●	●	●	●	●	
Extension interface						2ch	2ch	2ch	2ch	2ch	2ch	2ch	2ch	2ch	2ch	2ch	2ch	2ch	2ch	2ch	2ch	2ch	2ch	2ch	2ch	2ch	
Multimedia & Video/RGB interface						2ch	2ch	2ch	2ch	2ch	2ch	2ch	2ch	2ch	2ch	2ch	2ch	2ch	2ch	2ch	2ch	2ch	2ch	2ch	2ch	2ch	
Video/RGB interface						●	●	●	●	●	●	●	●	●	●	●	●	●	●	●	●	●	●	●	●	●	
Others	Vertical display					●	●	●	●	●	●	●	●	●	●	●	●	●	●	●	●	●	●	●	●	●	
	Clock function			(Battery)	P.52-	●	●	●	●	●	●	●	●	●	●	●	●	●	●	●	●	●	●	●	●	●	
	Buzzer output					●	●	●	●	●	●	●	●	●	●	●	●	●	●	●	●	●	●	●	●	●	
	Human sensor					●	●	●	●	●	●	●	●	●	●	●	●	●	●	●	●	●	●	●	●	●	
	Printer	Required (Printer unit)			P.33	●	●	●	●	●	●	●	●	●	●	●	●	●	●	●	●	●	●	●	●	●	
	Memory card unit (Memory card extension unit)	Required	Memory card unit/ Memory card extension unit			●	●	●	●	●	●	●	●	●	●	●	●	●	●	●	●	●	●	●	●	●	
	Sound output	Required	Sound output unit			●	●	●	●	●	●	●	●	●	●	●	●	●	●	●	●	●	●	●	●	●	
	External input/output	Required	External input/output unit			●	●	●	●	●	●	●	●	●	●	●	●	●	●	●	●	●	●	●	●	●	
	Video input / RGB input / RGB output	Required	Video/RGB unit	P.32		●	●	●	●	●	●	●	●	●	●	●	●	●	●	●	●	●	●	●	●	●	
	USB mouse/keyboard connection	Required		P.34		●	●	●	●	●	●	●	●	●	●	●	●	●	●	●	●	●	●	●	●	●	
Main unit functions	Backlight OFF detection function					●	●	●	●	●	●	●	●	●	●	●	●	●	●	●	●	●	●	●	●	●	
	Start from memory card	Required#2 (GT15 only)	Memory card			●	●	●	●	●	●	●	●	●	●	●	●	●	●	●	●	●	●	●	●	●	
	Project data read/write					●	●	●	●	●	●	●	●	●	●	●	●	●	●	●	●	●	●	●	●	●	
	Resource data read					●	●																				

Product list

Main unit model name

GT16 9 5 M - X T B A

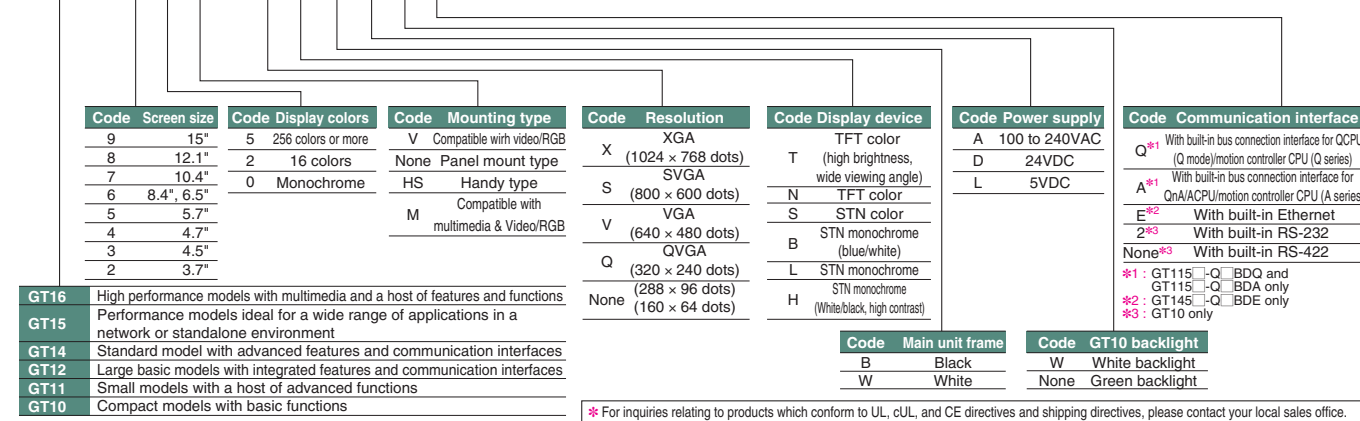

GOT main units

Model name	Screen size [resolution]	Display	Display colors (number of colors)	Power supply	Memory size	Remarks
GT1695	15" XGA [1024 x 768 dots]	TFT color LCD (high brightness, wide viewing angle)	65,536 colors	100-240VAC 24VDC	15MB	Compatible with multimedia & Video/RGB
GT1685	12.1" SVGA [800 x 600 dots]	TFT color LCD (high brightness, wide viewing angle)	65,536 colors	100-240VAC 24VDC	15MB	Compatible with multimedia & Video/RGB
GT1675	10.4" SVGA [800 x 600 dots]	TFT color LCD (high brightness, wide viewing angle)	65,536 colors	100-240VAC 24VDC	15MB	Compatible with multimedia & Video/RGB
GT1675M	10.4" VGA [640 x 480 dots]	TFT color LCD (high brightness, wide viewing angle)	65,536 colors	100-240VAC 24VDC	15MB	Compatible with multimedia & Video/RGB
GT1665	8.4" SVGA [800 x 600 dots]	TFT color LCD (high brightness, wide viewing angle)	65,536 colors	100-240VAC 24VDC	15MB	Compatible with multimedia & Video/RGB
GT1655	5.7" VGA [640 x 480 dots]	TFT color LCD (high brightness, wide viewing angle)	65,536 colors	24VDC	15MB	Handy GOT
GT1595	15" XGA [1024 x 768 dots]	TFT color LCD (high brightness, wide viewing angle)	65,536 colors	100-240VAC 24VDC	9MB	
GT1585	12.1" SVGA [800 x 600 dots]	TFT color LCD (high brightness, wide viewing angle)	65,536 colors	100-240VAC 24VDC	9MB	Compatible with Video/RGB
GT1575	10.4" SVGA [800 x 600 dots]	TFT color LCD (high brightness, wide viewing angle)	65,536 colors	100-240VAC 24VDC	9MB	Compatible with Video/RGB
GT1565	8.4" VGA [640 x 480 dots]	TFT color LCD (high brightness, wide viewing angle)	65,536 colors	100-240VAC 24VDC	9MB	
GT1555	5.7" VGA [640 x 480 dots]	TFT color LCD (high brightness, wide viewing angle)	65,536 colors	24VDC	9MB	
GT145	5.7" QVGA [320 x 240 dots]	STN color LCD	4,096 colors	24VDC	9MB	
GT1275	10.4" VGA [640 x 480 dots]	TFT color LCD	256 colors	100-240VAC 24VDC	6MB	
GT1265	8.4" VGA [640 x 480 dots]	TFT color LCD	256 colors	100-240VAC 24VDC	6MB	
GT1155	5.7" QVGA [320 x 240 dots]	STN color LCD	256 colors	24VDC	3MB	
GT1150	5.7" QVGA [320 x 240 dots]	STN monochrome LCD	Monochrome (black/white) 16 gray scales	24VDC	3MB	
GT1105	5.7" QVGA [320 x 240 dots]	STN monochrome LCD	Monochrome (blue/white) 16 gray scales	24VDC	3MB	
GT105	5.7" QVGA [320 x 240 dots]	STN color LCD	256 colors	24VDC	3MB	
GT104	4.7" QVGA [320 x 240 dots]	STN color LCD	256 colors	24VDC	3MB	

GOT main units

Model name	Screen size [resolution]	Display	Display colors (number of colors)	Power supply	Memory size	Remarks
GT1030	4.5" [288 x 96 dots]	STN monochrome LCD (High contrast)	3-color LED (green, orange, red) 24VDC	5VDC	1.5MB	Dedicated to RS-422 connection
GT1020	3.7" [160 x 64 dots]	STN monochrome LCD	3-color LED (green, orange, red) 24VDC	5VDC	512KB	Dedicated to RS-232 connection
GT1010	4.5" [288 x 96 dots]	STN monochrome LCD (High contrast)	3-color LED (green, orange, red) 24VDC	5VDC	1.5MB	Dedicated to RS-422 connection
GT1000	4.5" [288 x 96 dots]	STN monochrome LCD (High contrast)	3-color LED (green, orange, red) 24VDC	5VDC	1.5MB	Dedicated to RS-422 connection

*1: Not supported by GT Works2/GT Designer2.

Communication interface

Product name	Model name	Specifications	Applicable model						
			GT16	GT15	GT14	GT12	GT11	Handy GOT	GT10
Bus connection unit	GT15-QBUS	Bus connection (1ch) unit standard model for QCPU (Q mode)/motion controller CPU (Q series)	●	●	—	—	—	—	—
	GT15-QBUS2	Bus connection (2ch) unit standard model for QCPU (Q mode)/motion controller CPU (Q series)	●	●	—	—	—	—	—
	GT15-ABUS	Bus connection (1ch) unit standard model for QnA/ACPU/motion controller CPU (A series)	●	●	—	—	—	—	—
	GT15-ABUS2	Bus connection (2ch) unit standard model for QnA/ACPU/motion controller CPU (A series)	●	●	—	—	—	—	—
	GT15-75QBUSL	Bus connection (1ch) unit thin model*1 for QCPU (Q mode)/motion controller CPU (Q series)	●	●	—	—	—	—	—
	GT15-75QBUS2L	Bus connection (2ch) unit thin model*1 for QCPU (Q mode)/motion controller CPU (Q series)	●	●	—	—	—	—	—
	GT15-75ABUSL	Bus connection (1ch) unit thin model*1 for QnA/ACPU/motion controller CPU (A series)	●	●	—	—	—	—	—
Serial communication unit	GT15-RS2-9P	RS-232 serial communication unit (D-sub 9-pin (male))	●	●	—	—	—	—	—
	GT15-RS4-9S	RS-422/485 serial communication unit (D-sub 9-pin (female))*2 *3	●	●	—	—	—	—	—
	GT15-RS4-TE	RS-422/485 serial communication unit (terminal block)*2	●	●	—	—	—	—	—
RS-422 conversion unit	GT15-RS2T4-9P	RS-232→RS-422 conversion unit	●	●	—	—	—	—	—
	GT15-RS2T4-25P	RS-422 connector: 9-pin	●	●	—	—	—	—	—
MELSECNET/H communication unit	GT15-J71LP23-25	Standard station unit (optical loop)	●	●	—	—	—	—	—
	GT15-J71BR13	Standard station unit (coaxial bus)	●	●	—	—	—	—	—
CC-Link IE Controller Network communication unit	GT15-J71GP23-SX	Standard station unit (optical loop)	●	●	—	—	—	—	—
CC-Link IE Field Network communication unit	GT15-J71GF13-T2	Intelligent device station unit	●	●	—	—	—	—	—
CC-Link communication unit	GT15-J61BT13	Intelligent device station unit (supporting CC-Link version 2)	●	●	—	—	—	—	—
Ethernet communication unit	GT15-J71E71-100	Ethernet (100Base-TX) unit	—	—	—	—	—	—	—
Serial multi-drop connection unit	GT01-RS4-M	For GOT multi-drop connection	●	●	—	—	—	—	—
Connector conversion adapter	GT10-9PT5S	Conversion connector between D sub 9-pin male and Europe terminal block 5-pin	—	—	—	—	—	—	—
RS-232/485 Signal Conversion Adapter	GT14-RS2T4-9P	Conversion adapter from RS-232 to RS-485	—	—	—	—	—	—	—
CC-Link interface unit	GT11HS-CCL	CC-Link interface unit for Handy GOT	—	—	—	—	—	—	—
	GT11H-CCL	CC-Link interface unit for Handy GOT	—	—	—	—	—	—	—

*1: The unit cannot be used stacked on other units.
 *2: The unit may not be able to be used depending on the connection destination. See "List of connectable models" (page 65).
 *3: The unit cannot be used when connecting to temperature controllers/indicating controllers via RS-485 (2-wire type).
 *4: The unit cannot be used with the GT1555.
 *5: For the hardware version compatible with GOT, please contact your local sales office.
 *6: For the instructions for connection of GT16/GT15, please contact your local sales office.
 *7: When using the unit in a direct connection with a QCPU, only the QnUCPU is supported.

Optional units

Product name	Model name	Specifications	Applicable model						
			GT16	GT15	GT14	GT12	GT11	Handy GOT	GT10
Printer unit	GT15-PRN	USB slave (PictBridge) for printer connection, 1ch * Cable for printer connection (3m) included	●	●	—	—	—	—	—
Multimedia unit	GT16M-MMR	For video input (NTSC/PAL) 1ch Record video images/play video files	●	●	—	—	—	—	—
Video input unit	GT16M-V4	For video input (NTSC/PAL) 4ch	●	●	—	—	—	—	—
	GT15V-75V4	For video input (NTSC/PAL) 4ch	●	●	—	—	—	—	—
RGB input unit	GT16M-R2	For analog RGB input 2ch	●	●	—	—	—	—	—
	GT15V-75R1	For analog RGB input 1ch	●	●	—	—	—	—	—
Video/RGB input unit	GT16M-V4R1	For video input (NTSC/PAL) 4ch / analog RGB 1ch composite input	●	●	—	—	—	—	—
	GT15V-75V4R1	For video input (NTSC/PAL) 4ch / analog RGB 1ch composite input	—	●	—	—	—	—	—
RGB output unit	GT16M-ROUT	For analog RGB output 1ch	●	●	—	—	—	—	—
	GT15V-75ROUT	For analog RGB output 1ch	—	●	—	—	—	—	—
CF card unit	GT15-CFCD	For additional CF card port (B drive) on the back of the GOT	●	●	—	—	—	—	—
CF card extension unit	GT15-CFEX-C08SET	For additional CF card port (B drive) at the front of the control panel*1	●	●	—	—	—	—	—
Sound output unit	GT15-SOUT	For sound output	●	●	—	—	—	—	—
External input/output unit	GT15-DIOR	For external input/output devices and operation panel connection (negative common input / source type output)	●	●	—	—	—	—	—
	GT15-DIO	For external input/output devices and operation panel connection (positive common input / sink type output)	●	●	—	—	—	—	—

*1: Includes unit to be installed on the control panel, unit to be installed on the GOT, and connection cable (0.8m).
 *2: Excluding the GT16-VNB and GT1655.
 *3: Only the GT1585V and GT1575V are supported.

INDEX

For Designers

For Initial Startup & Operations

For Maintenance Personnel

GT10

IQ Platform

MELSEC Process Control

Specifications, External Dimensions

List of Connectable Models, etc.

Product list

Software

Product name	Model name	Contents
HMI Screen Design Software MELSOFT GT Works3 Version1	SW1DNC-GTWK3-E	Single license *CD-ROM English version
	SW1DNC-GTWK3-EA	Multiple-license*#1 *CD-ROM English version
FA Integrated Engineering Software MELSOFT iQ Works #3	SW1DNC-IQWK-E	Single license *CD-ROM English version
	SW1DND-IQWK-E	Single license *DVD-ROM English version
License key for GT SoftGOT1000#4	GT15-SGTKEY-U	For USB port
Personal computer remote operation function (Ethernet) license#5	GT16-PCRAKEY	1 license
VNC® server function license#5	GT16-VNCSKEY NEW	1 license

- #1: The desired number of licenses (2 or more) can be purchased. For details, please contact your local sales office.
 #2: Multiple-license product and additional license product are also available. For more details, please refer to the MELSOFT iQ Works catalog (L(NA)08232).
 #3: The product includes the following software.
 • System Management Software [MELSOFT Navigator] • Programmable Controller Engineering Software [MELSOFT MT Works2]
 • Servo Setup Software [MELSOFT MT Configurator2] • Screen Design Software for Graphic Operation Terminal [MELSOFT GT Works3] • Motion Controller Engineering Software [MELSOFT MT Works2]
 #4: To use GT SoftGOT1000, a license key for GT SoftGOT1000 is necessary for each personal computer. • Robot Programming Software [MELSOFT RT ToolBox2 mini]
 #5: 1 license is required for 1 GOT unit.

Options

Product name	Model name	Specifications	Applicable model							
			GT16	GT15	GT14	GT12	GT11	Handy GOT	GT10	
Backlight	GT16-90XLTT	For GT1695M-XTB	●	—	—	—	—	—	—	—
	GT16-80SLTT	For GT1685M-STB	●	—	—	—	—	—	—	—
	GT16-70SLTT	For GT1675M-STB	●	—	—	—	—	—	—	—
	GT16-70VLT	For GT1675M-VTB #1	●	—	—	—	—	—	—	—
	GT16-70VLT	For GT1675M-VTB #2	●	—	—	—	—	—	—	—
	GT16-60SLTT	For GT1675-VNB /GT1672-VNB	●	—	—	—	—	—	—	—
	GT16-60VLT	For GT1665M-STB	●	—	—	—	—	—	—	—
	GT16-60VLT	For GT1665M-VTB	●	—	—	—	—	—	—	—
	GT16-60VLT	For GT1662-VNB	●	—	—	—	—	—	—	—
	GT15-90XLTT	For GT1595-VTB	●	—	—	—	—	—	—	—
	GT15-80SLTT	For GT1585V-STB /GT1585-STB	●	—	—	—	—	—	—	—
	GT15-70SLTT	For GT1575-STB #3	●	—	—	—	—	—	—	—
	GT15-70VLT	For GT1575V-STB /GT1575-VTB /GT1575-STB #4	●	—	—	—	—	—	—	—
	GT15-70VLT	For GT1575-VNB /GT1572-VNB	●	—	—	—	—	—	—	—
	GT15-60VLT	For GT1565-VTB	●	—	—	—	—	—	—	—
GT15-60VLT	For GT1562-VNB	●	—	—	—	—	—	—	—	
GT12-70VLT	For GT1275-VNB	●	—	—	—	—	—	—	—	
GT12-60VLT	For GT1265-VNB	●	—	—	—	—	—	—	—	
Optional function board	GT16-MESB	For MES interface function (No expansion memory)	●	—	—	—	—	—	—	—
	GT15-FNB	(No expansion memory)	—	●	—	—	—	—	—	—
	GT15-QFNB	+ 16MB expansion memory	—	●	—	—	—	—	—	—
	GT15-QFNB16M	+ 32MB expansion memory	—	●	—	—	—	—	—	—
	GT15-QFNB32M	+ 48MB expansion memory	—	●	—	—	—	—	—	—
	GT15-QFNB48M	+ 48MB expansion memory	—	●	—	—	—	—	—	—
	GT11-50FNB	—	—	—	—	—	—	●#5	●#9	—
GT10 memory loader	GT10-LDR	For GT1030/GT1020 (for OS project data transfer) no power source required	—	—	—	—	—	—	—	●
GT10 memory board	GT10-50FMB	For GT105 /GT104 (for OS and project data transfer)	—	—	—	—	—	—	—	●
Protective sheet	GT16-90PSCB	Clear, 5 sheets	●	—	—	—	—	—	—	—
	GT16-90PSGB	Anti-glare, 5 sheets	●	—	—	—	—	—	—	—
	GT16-90PSCW	Clear (frame: white), 5 sheets	●	—	—	—	—	—	—	—
	GT16-90PSGW	Anti-glare (frame: white), 5 sheets	●	—	—	—	—	—	—	—
	GT16-90PSCB-012	Clear (USB protective cover type), 5 sheets#14	●	—	—	—	—	—	—	—
	GT15-90PSCB	Clear, 5 sheets	—	●	—	—	—	—	—	—
	GT15-90PSGB	Anti-glare, 5 sheets	—	●	—	—	—	—	—	—
	GT15-90PSCW	Clear (frame: white), 5 sheets	—	●	—	—	—	—	—	—
	GT15-90PSGW	Anti-glare (frame: white), 5 sheets	—	●	—	—	—	—	—	—
	GT16-80PSCB	Clear, 5 sheets	●	—	—	—	—	—	—	—
	GT16-80PSGB	Anti-glare, 5 sheets	●	—	—	—	—	—	—	—
	GT16-80PSCW	Clear (frame: white), 5 sheets	●	—	—	—	—	—	—	—
	GT16-80PSGW	Anti-glare (frame: white), 5 sheets	●	—	—	—	—	—	—	—
	GT16-80PSCB-012	Clear (USB protective cover type), 5 sheets#14	●	—	—	—	—	—	—	—
	GT15-80PSCB	Clear, 5 sheets	—	●	—	—	—	—	—	—
	GT15-80PSGB	Anti-glare, 5 sheets	—	●	—	—	—	—	—	—
	GT15-80PSCW	Clear (frame: white), 5 sheets	—	●	—	—	—	—	—	—
	GT15-80PSGW	Anti-glare (frame: white), 5 sheets	—	●	—	—	—	—	—	—
	GT16-70PSCB	Clear, 5 sheets	●	—	—	—	—	—	—	—
	GT16-70PSGB	Anti-glare, 5 sheets	●	—	—	—	—	—	—	—
	GT16-70PSCW	Clear (frame: white), 5 sheets	●	—	—	—	—	—	—	—
	GT16-70PSGW	Anti-glare (frame: white), 5 sheets	●	—	—	—	—	—	—	—
	GT16-70PSCB-012	Clear (USB protective cover type), 5 sheets#14	●	—	—	—	—	—	—	—
	GT15-70PSCB	Clear, 5 sheets	—	●	—	—	—	—	—	—
GT15-70PSGB	Anti-glare, 5 sheets	—	●	—	—	—	—	—	—	
GT15-70PSCW	Clear (frame: white), 5 sheets	—	●	—	—	—	—	—	—	
GT15-70PSGW	Anti-glare (frame: white), 5 sheets	—	●	—	—	—	—	—	—	
GT11-70PSCB	Clear, 5 sheets	—	—	—	●	—	—	—	—	
GT16-60PSCB	Clear, 5 sheets	●	—	—	—	—	—	—	—	
GT16-60PSGB	Anti-glare, 5 sheets	●	—	—	—	—	—	—	—	
GT16-60PSCW	Clear (frame: white), 5 sheets	●	—	—	—	—	—	—	—	
GT16-60PSGW	Anti-glare (frame: white), 5 sheets	●	—	—	—	—	—	—	—	
GT16-60PSCB-012	Clear (USB protective cover type), 5 sheets#14	●	—	—	—	—	—	—	—	
GT15-60PSCB	Clear, 5 sheets	—	●	—	—	—	—	—	—	
GT15-60PSGB	Anti-glare, 5 sheets	—	●	—	—	—	—	—	—	
GT15-60PSCW	Clear (frame: white), 5 sheets	—	●	—	—	—	—	—	—	
GT15-60PSGW	Anti-glare (frame: white), 5 sheets	—	●	—	—	—	—	—	—	
GT11-60PSCB	Clear, 5 sheets	—	—	—	●	—	—	—	—	
GT16H-60PSC	Clear, 5 sheets	—	—	—	—	●	—	—	—	
GT16-50PSCB	Clear, 5 sheets	●	—	—	—	—	—	—	—	
GT16-50PSGB	Anti-glare, 5 sheets	●	—	—	—	—	—	—	—	
GT16-50PSCW	Clear (frame: white), 5 sheets	●	—	—	—	—	—	—	—	
GT16-50PSGW	Anti-glare (frame: white), 5 sheets	●	—	—	—	—	—	—	—	
GT16-50PSCB-012	Clear (USB protective cover type), 5 sheets#14	●	—	—	—	—	—	—	—	
GT15-50PSCB	Clear, 5 sheets	—	●	—	—	—	—	—	—	
GT15-50PSGB	Anti-glare, 5 sheets	—	●	—	—	—	—	—	—	
GT15-50PSCW	Clear (frame: white), 5 sheets	—	●	—	—	—	—	—	—	
GT15-50PSGW	Anti-glare (frame: white), 5 sheets	—	●	—	—	—	—	—	—	
GT14-50PSCB NEW	Clear, 5 sheets	—	—	—	●	—	—	—	—	
GT14-50PSGB NEW	Anti-glare, 5 sheets	—	—	—	●	—	—	—	—	
GT14-50PSCW NEW	Clear (frame: white), 5 sheets	—	—	—	●	—	—	—	—	
GT14-50PSGW NEW	Anti-glare (frame: white), 5 sheets	—	—	—	●	—	—	—	—	
GT11-50PSCB	Clear, 5 sheets	—	—	—	—	●	—	—	—	
GT11-50PSGB	Anti-glare, 5 sheets	—	—	—	—	●	—	—	—	
GT11-50PSCW	Clear (frame: white), 5 sheets	—	—	—	—	●	—	—	—	
GT11-50PSGW	Anti-glare (frame: white), 5 sheets	—	—	—	—	●	—	—	—	

Options

Product name	Model name	Specifications	Applicable model							
			GT16	GT15	GT14	GT12	GT11	Handy GOT	GT10	
Protective sheet	GT11H-50PSC	Protective sheet for 5.7" screen (for GT11 Handy GOT)	—	—	—	—	—	—	—	—
	GT10-50PSCB	Clear, 5 sheets	—	—	—	—	—	—	—	—
	GT10-50PSGB	Anti-glare, 5 sheets	—	—	—	—	—	—	—	—
	GT10-50PSCW	Clear (frame: white), 5 sheets	—	—	—	—	—	—	—	—
	GT10-50PSGW	Anti-glare (frame: white), 5 sheets	—	—	—	—	—	—	—	—
	GT10-40PSCB	Clear, 5 sheets	—	—	—	—	—	—	—	—
	GT10-40PSGB	Anti-glare, 5 sheets	—	—	—	—	—	—	—	—
	GT10-40PSCW	Clear (frame: white), 5 sheets	—	—	—	—	—	—	—	—
	GT10-40PSGW	Anti-glare (frame: white), 5 sheets	—	—	—	—	—	—	—	—
	GT10-30PSCB	Clear, 5 sheets	—	—	—	—	—	—	—	—
	GT10-30PSGB	Anti-glare, 5 sheets	—	—	—	—	—	—	—	—
	GT10-30PSCW	Clear (frame: white), 5 sheets	—	—	—	—	—	—	—	—
	GT10-30PSGW	Anti-glare (frame: white), 5 sheets	—	—	—	—	—	—	—	—
	GT10-20PSCB	Clear, 5 sheets	—	—	—	—	—	—	—	—
	GT10-20PSGB	Anti-glare, 5 sheets	—	—	—	—	—	—	—	—
GT10-20PSCW	Clear (frame: white), 5 sheets	—	—	—	—	—	—	—	—	
GT10-20PSGW	Anti-glare (frame: white), 5 sheets	—	—	—	—	—	—	—	—	
USB protective cover	GT16-UCOV	Protective cover for USB interface on main unit front panel (for replacement)	●	—	—	—	—	—	—	—
	GT15-UCOV	For 15"/12.1"/10.4"/8.4"	●	—	—	—	—	—	—	—
	GT14-50UCOV NEW	For 15"/12.1"/10.4"/8.4"	—	●	—	—	—	—	—	—
	GT11-50UCOV	For 5.7"	—	—	—	—	—	—	—	—
Oil resistant cover#7	GT05-90PCO	Oil resistant cover for 15" screen	●	●	—	—	—	—	—	—
	GT05-80PCO	Oil resistant cover for 12.1" screen	●	●	—	—	—	—	—	—
	GT05-70PCO	Oil resistant cover for 10.4" screen	●	●	—	—	—	—	—	—
	GT05-60PCO	Oil resistant cover for 8.4" screen	●	●	—	—	—	—	—	—
	GT16-50PCO	Oil resistant cover for 5.7" screen	●	—	—	—	—	—	—	—
	GT05-50PCO	Oil resistant cover for 5.7" screen	—	●	—	—	—	—	—	—
	GT10-40PCO	Oil resistant cover for 4.7" screen	—	—	—	—	—	—	—	—
	GT10-30PCO	Oil resistant cover for 4.5" screen	—	—	—	—	—	—	—	—
	GT10-20PCO	Oil resistant cover for 3.7" screen	—	—	—	—	—	—	—	—
	Emergency stop switch guard	GT16H-60ESCOV	Cover for accidental operation prevention of emergency stop switch (for GT16 Handy GOT)	—	—	—	—	—	—	—
GT11H-50ESCOV		Cover for accidental operation prevention of emergency stop switch (for GT11 Handy GOT)	—	—	—	—	—	—	—	—
Stand	GT15-90STAND	Stand for 15" type	●	●	—	—	—	—	—	—
	GT15-80STAND	Stand for 12.1" type	●	●	—	—	—	—	—	—
	GT15-70STAND	Stand for 10.4"/8.4" type	●	●	—	—	—	—	—	—
Memory card	GT05-50STAND	Stand for 5.7" type	●	●	—	—	—	—	—	—

Product list

Cables

Product name	Model name	Cable length	Third party products #1	Application	Applicable model #2									
					GT16	GT15	GT14	GT12	GT11	Handy GOT	GT10			
Bus connection cable for QCPU (Q mode)	QCPU extension cable GOT-to-GOT connection cable	GT15-QC06B	0.6m	○	For connection between QCPU and GOT For connection between GOT and GOT	●	●	—	—	●	—	—		
		GT15-QC12B	1.2m			●	●	—	—	●	—	—		
		GT15-QC30B	3m			●	●	—	—	●	—	—		
		GT15-QC50B	5m			●	●	—	—	●	—	—		
		GT15-QC100B	10m			●	●	—	—	●	—	—		
	Long-distance connection cable for QCPU GOT-to-GOT long-distance connection cable	GT15-QC150BS	15m	○	For long-distance (13.2m or more) connection between QCPU and GOT (A9GT-QCNB required) For long-distance connection between GOT and GOT	●	●	—	—	●	—	—		
GT15-QC200BS	20m	●	●			—	—	●	—	—				
GT15-QC250BS	25m	●	●			—	—	●	—	—				
GT15-QC300BS	30m	●	●			—	—	●	—	—				
GT15-QC350BS	35m	●	●	—	—	●	—	—						
Bus extension connector box	A9GT-QCNB	—	—	Used for QCPU long-distance (13.2m or more) bus connection	●	●	—	—	●	—	—			
Large CPU extension cable	GT15-C12NB	1.2m	○	For connection between QnA/ACPU/motion controller CPU (A series, extension base) and GOT	●	●	—	—	●	—	—			
	GT15-C30NB	3m			●	●	—	—	●	—	—			
	GT15-C50NB	5m			●	●	—	—	●	—	—			
	GT15-AC06B	0.6m	○	For connection between QnA/ACPU/motion controller CPU (A series, extension base) and A7GT-CNB	●	●	—	—	●	—	—			
	GT15-AC12B	1.2m			●	●	—	—	●	—	—			
	GT15-AC30B	3m			●	●	—	—	●	—	—			
	GT15-AC50B	5m			●	●	—	—	●	—	—			
	GT15-A370C12B-S1	1.2m			●	●	—	—	●	—	—			
	GT15-A370C25B-S1	2.5m	○	For connection between motion controller CPU (A series, main base) and GOT	●	●	—	—	●	—	—			
	GT15-A370C12B	1.2m			●	●	—	—	●	—	—			
	GT15-A370C25B	2.5m			●	●	—	—	●	—	—			
	Small CPU extension cable	GT15-A1SC07B	0.7m	○	For connection between QnAS/AnSCPU/motion controller CPU (A series) and GOT	●	●	—	—	●	—	—		
		GT15-A1SC12B	1.2m			●	●	—	—	●	—	—		
		GT15-A1SC30B	3m	○	For connection between QnAS/AnSCPU and GOT	●	●	—	—	●	—	—		
		GT15-A1SC50B	5m			●	●	—	—	●	—	—		
GT15-A1SC05NB		0.45m	○	For connection between QnAS/AnSCPU/motion controller CPU (A series) and A7GT-CNB	●	●	—	—	●	—	—			
GT15-A1SC07NB		0.7m			●	●	—	—	●	—	—			
GT15-A1SC30NB		3m	○	For connection between QnAS/AnSCPU and A7GT-CNB	●	●	—	—	●	—	—			
GT15-A1SC50NB		5m			●	●	—	—	●	—	—			
Small CPU long-distance connection cable		GT15-C100EXSS-1	10.6m	○	For long-distance connection between QnAS/AnSCPU/motion controller CPU (A series) and GOT For long-distance connection between A7GT-CNB and GOT *Set of GT15-EXCNB and GT15-C-BS	●	●	—	—	●	—	—		
		GT15-C200EXSS-1	20.6m			●	●	—	—	●	—	—		
	GT15-C300EXSS-1	30.6m	●			●	—	—	●	—	—			
GOT-to-GOT connection cable	GT15-C07BS	0.7m	○	For connection between GOT and GOT	●	●	—	—	●	—	—			
	GT15-C12BS	1.2m			●	●	—	—	●	—	—			
	GT15-C30BS	3m			●	●	—	—	●	—	—			
	GT15-C50BS	5m			●	●	—	—	●	—	—			
GOT-to-GOT long-distance connection cable	GT15-C100BS	10m	○	For connection between GOT and GOT	●	●	—	—	●	—	—			
	GT15-C200BS	20m			●	●	—	—	●	—	—			
	GT15-C300BS	30m			●	●	—	—	●	—	—			
A0J2HCPU connection cable	GT15-J2C10B	1m	○	For connection between power supply unit (A0J2-PW) for A0J2HCPU and GOT	●	●	—	—	●	—	—			
Bus connector conversion box	A7GT-CNB	—	—	Used for QnA/ACPU long-distance bus connection	●	●	—	—	●	—	—			
Buffer circuit cable	GT15-EXCNB	0.5m	○	Usable as GT15-C-EXSS-1 in combination with GT15-C-BS	●	●	—	—	●	—	—			
Ferrite core set for Q bus cable (two-pack)	GT15-QFC	—	○	Ferrite cores for replacing existing GOT-A900 bus cable with bus cable for GOT1000	●	●	—	—	●	—	—			
Ferrite core set for A bus cable (two-pack)	GT15-AFC	—	○	Ferrite cores for replacing existing GOT-A900 bus cable with bus cable for GOT1000	●	●	—	—	●	—	—			
RS-422 conversion cable	GT16-C02R4-9S	0.2m	○	For connection between RS-422/485 (connector) of GT16 and RS-422 cable (D-sub 9 pins)	●	—	—	—	—	—	—			
	GT16-C02R4-25S	0.2m	○	For connection between RS-422/485 (connector) of GT16 and RS-422 cable (D-sub 25 pins)	●	—	—	—	—	—	—			
RS-485 terminal block conversion unit	FA-LTBGTR4CBL05	0.5m	○	RS-485 terminal block conversion unit *With cable for connection between RS-422/485 (connector) of GT16 and RS-485 terminal block conversion unit	●	—	—	—	—	—	—			
	FA-LTBGTR4CBL10	1m			●	—	—	—	—	—	—			
	FA-LTBGTR4CBL20	2m			●	—	—	—	—	—	—			
QnA/FXCPU direct connection cable	GT01-C30R4-25P	3m	—	For connection between QnA/ACPU/motion controller CPU (A series)/FXCPU (D-sub 25-pin connector) and GOT For connection between FA-CNV-CBL and GOT For connection between serial communication unit and GOT For connection between AJ65BT-G4-S3 and GOT	●	●	●	●	●	—	●			
	GT01-C100R4-25P	10m			●	●	●	●	●	—	●			
	GT01-C200R4-25P	20m			●	●	●	●	●	—	●			
	GT01-C300R4-25P	30m			●	●	●	●	●	—	●			
	GT10-C30R4-25P	3m			—	—	—	—	—	—	—	●		
	GT10-C100R4-25P	10m	—	For connection between QnA/FXCPU (D-sub 25-pin connector) and GOT For connection between serial communication unit (AJ71QC24(N)-R4) and GOT	—	—	—	—	—	—	●			
	GT10-C200R4-25P	20m			—	—	—	—	—	—	●			
	GT10-C300R4-25P	30m			—	—	—	—	—	—	●			
	Computer link connection cable	GT09-C30R4-6C	3m	○	For connection between serial communication unit and GOT For connection between computer link unit and GOT	●	●	●	●	●	—	●		
		GT09-C100R4-6C	10m			●	●	●	●	●	—	●		
		GT09-C200R4-6C	20m			●	●	●	●	●	—	●		
		GT09-C300R4-6C	30m			●	●	●	●	●	—	●		
GT01-C10R4-8P		1m	—			For connection between FXCPU (MINI-DIN 8-pin connector) and GOT For connection between FXCPU communication function extension board (MINI-DIN 8-pin connector) and GOT	●	●	●	●	●	—	●	
GT01-C30R4-8P	3m	●		●	●		●	●	—	●				
GT01-C100R4-8P	10m	●		●	●		●	●	—	●				
GT01-C200R4-8P	20m	●		●	●		●	●	—	●				
GT01-C300R4-8P	30m	●		●	●		●	●	—	●				
FXCPU direct connection cable	GT10-C10R4-8P	1m	—	For connection between FXCPU communication function extension board (MINI-DIN 8-pin connector) and GOT	—	—	—	—	—	—	●			
	GT10-C30R4-8P	3m			—	—	—	—	—	—	—	●		
	GT10-C100R4-8P	10m			—	—	—	—	—	—	—	●		
	GT10-C200R4-8P	20m			—	—	—	—	—	—	—	●		
	GT10-C300R4-8P	30m			—	—	—	—	—	—	—	●		
	GT10-C10R4-8PC	1m			—	For connection between FXCPU (MINI-DIN 8-pin connector) and GOT	—	—	—	—	—	—	●	
	GT10-C30R4-8PC	3m					—	—	—	—	—	—	—	●
	GT10-C100R4-8PC	10m					—	—	—	—	—	—	—	●
	GT10-C200R4-8PC	20m					—	—	—	—	—	—	—	●
	GT10-C300R4-8PC	30m					—	—	—	—	—	—	—	●
Connector conversion cable for F930→GT1030 replacement	GT10-C02H-9SC	0.2m	—	For replacing a F930GOT unit with the GT1030 series unit Converts D-sub 9-pin connector to loose wire (Europe terminal block)	—	—	—	—	—	●				
Q/LCPU direct connection cable	GT01-C30R2-6P	3m	—	For connection between personal computer (screen design software) (D-sub 9-pin, female) and GOT (MINI-DIN 6-pin, male) For connection between Q/LCPU and GOT For connection between GOT and GOT	●	●	●	●	●	—	●			
	GT10-C30R2-6P	3m			—	—	—	—	—	—	—	●		
	GT11H-C30R2-6P	3m			—	—	—	—	—	—	—	●		
	GT11H-C30R2-6P	3m			—	—	—	—	—	—	—	●		

Cables

Product name	Model name	Cable length	Third party products #1	Application	Applicable model #2							
					GT16	GT15	GT14	GT12	GT11	Handy GOT	GT10	
RS-232 cable	FX communication function extension board connection cable, FX communication function adapter connection cable, Data transfer cable	GT01-C30R2-9S	3m	—	For connection between FXCPU communication function extension board (D-sub 9-pin connector) and GOT/personal computer (GT SoftGOT1000) (D-sub 9-pin) For connection between FXCPU communication function adapter (D-sub 9-pin connector) and GOT For connection between personal computer (screen design software) (D-sub 9-pin, female) and GOT (D-sub 9-pin, female)	●	●	●	●	●	●	●
		GT01-C30R2-25P	3m			●	●	●	●	●	●	●
	Computer link connection cable	GT09-C30R2-9P	3m	○	For connection between serial communication unit and GOT For connection between computer link unit and GOT For connection between AJ65BT-R2N and GOT (GT09-C30R2-9P only)	●	●	●	●	●	●	●
GT09-C30R2-25P	3m	●	●			●	●	●	●	●		
Connector conversion box for Handy GOT	GT16H-CNB-42S	—	—	Converts Handy GOT connector to RJ45 for terminal block, D-sub connector or Ethernet for each signal type	—	—	—	—	—	—	●	
	GT11H-CNB-37S	—	—	Converts D-sub 37-pin connector to terminal block and D-sub 9-pin connector	—	—	—	—	—	—	●	
External connection cable	FA device, power supply and operation switch connection cable	GT16H-C30-42P	3m	—	For connection between connector conversion box and Handy GOT	—	—	—	—	—	—	●
		GT16H-C60-42P	6m			—	—	—	—	—	—	●
		GT16H-C100-42P	10m			—	—	—	—	—	—	●
		GT16H-C30-32P	3m			—	—	—	—	—	—	●
		GT16H-C50-32P	5m			—	—	—	—	—	—	●
		GT16H-C80-32P	8m			—	—	—	—	—	—	●
	Dedicated cable for CC-Link interface unit	GT11H-C30	3m	—	For connection between CC-Link interface unit and Handy GOT	—	—	—	—	—	—	●
		GT11H-C60	6m			—	—	—	—	—	—	●
		GT11H-C100	10m			—	—	—	—	—	—	●
		GT11H-C30-32P	3m			—	—	—	—	—	—	●
		GT11H-C50-32P	5m			—	—	—	—	—	—	●
		GT11H-C80-32P	8m			—	—	—	—	—	—	●
FA device connection relay cable	RS-422, power supply and operation switch connection cable	GT11H-C15R4-8P	1.5m	—	For connection between FXCPU and GOT For connection between power supply and operation switches and GOT	—	—	—	—	—	—	●
		GT11H-C15R4-25P	1.5m			—	—	—	—	—	—	●
	RS-232, power supply and operation switch connection cable	GT11H-C15R2-6P	1.5m	—	For connection between QCPU and GOT For connection between power supply and operation switches and GOT	—	—	—	—	—	—	●
Barcode reader connection cable	GT10-C02H-6PT9P	0.2m	—	For connection between barcode reader (D-sub 9-pin, male) and GOT (MINI-DIN 6-pin, male) RS-232	—	—	—	—	—	—	●	
External I/O unit connection conversion cable	GT15-C03HTB	0.3m	○	For connection between GOT1000 (external I/O unit) and GOT-A900 external I/O interface unit connection cable (A8GT-C05TK/A8GT-C30TB/user-fabricated cable)	●	●	—	—	—	—	—	
Analog RGB cable	GT15-C50VG	5m	○	For connection between external monitor, personal computer and vision sensor and GOT	●	●	—	—	—	—	—	
USB cable	RS-232/USB conversion adapter for data transfer	GT10-RS2TUSB-5S	—	—	For connection between personal computer (USB) and GOT (RS-232) (Adapter and personal computer are connected with GT09-C30USB-5P.)	—	—	—	—	—	—	●
	Data transfer cable	GT09-C30USB-5P	3m	○	For connection between personal computer (USB) and GOT (USB mini-B) For connection between QnL/CPU (USB mini-B) and personal computer (GT SoftGOT1000) For connection between printer and GOT (printer unit)	●	●	—	—	—	—	—
Extension USB waterproof cable	GT14-C10EXUSB-4S	1m	—	For extending the USB port of GOT to the control panel	—	—	—	—	—	—	—	●
	GT10-C10EXUSB-5S	1m	—		—	—	—	—	—	—	—	—

#1 : FA-LTBGTR4CBL is developed by Mitsubishi Electric Engineering Company Limited and sold through your local sales office.
 The other products listed are developed by Mitsubishi Electric System & Service Co., LTD. and sold through your local sales office.
 #2 : The applicable connection configuration and cable vary depending on the GOT main unit. For more details, see the GOT1000 Series Handbook and the GOT1000 Series Connection Manual.
 #3 : Can be used when used together with the Handy GOT connector conversion box.
 #4 : Can be used only with the GT105 and GT104.
 #5 : Can be used only with the GT1030 and GT1020.
 #6 : To connect with RS-422/485 interface of GT16 main unit, an RS-422 conversion cable (GT16-C02R4-9S) is required.
 #7 : Can be used only with the GT16 Handy.
 #8 : Can be used only with the GT11 Handy.

Cables for third party FA devices

Product list

Cables for third party FA devices

Product name	Model name	Cable length	Third party products *1	GOT connection destination	Applicable model *2								
					GT16	GT15	GT14	GT12	GT11	Handy GOT	GT10		
RS-232 cable	Cable for YASKAWA Electric PLC	GT09-C30R20201-9P	3m	PLC CPU: GL120/GL130/MP-920/MP-930/CP-9200(H)/PROGIC-8 (port 1) MEMOBUS module: JAMSC-IF60/JAMSC-IF61 Communication module: 2171F/CP-2171F (when connected to CN1)/2171F-01/2181F-01 PLC CPU: PROGIC-8 (port 2) PLC CPU: CP-9300MS PLC CPU: MP-940 MEMOBUS module: CP-2171F (when connected to CN2) Yokogawa Electric personal computer module: LC01-0N/LC02-0N CPU port/D-sub 9-pin conversion cable: KM10-0C/KM10-0S Personal computer link module: F3LC01-1N/F3LC11-1N/F3LC11-1F/F3LC12-1F PLC CPU: NFPC100/NFJT100 Converter: ML2-□ PLC CPU: SL500 series HMI adapter PLC CPU: CV500/CV1000/CV2000/CVM1 Serial communication unit: CJ1W-SCU41 Serial communication board: CQM1-SCB41/CS1W-SCB41 Communication board: C200HW-COM03/COM06 Base mount type host link unit: C200H-LK202-V1/C500-LK201-V1 Communication board: CP1W-CIF11/CP1W-CIF12/CJ1W-CIF11 Multi-communication unit: KV-L20/KV-L20R/KV-L20V (port 2) PLC CPU: JW-22CUH/70CUH/100CUH/100CU PLC CPU: JW-32CUH/33CUH/Z-512J Link unit: JW-21CM/JW-10CM/ZW-10CM PLC CPU: PC3J/PC3JL Communication module: PC/CMP2-LINK PLC CPU: T2/T3/T3H/model3000(S3) PLC CPU: T2E/model2000(S2) PLC CPU: T2N Intelligent serial port module: COMM-H/COMM-2H PLC CPU: LQP510 Communication module: LQE565/LQE165 RS-232C/485 interface capsule: FFK120A-C10 General interface module: NC1L-RS4/FFU120B MEMOBUS module: JAMSC-120NOM27100/JAMSC-IF612 PLC CPU: MP940 Personal computer link module: F3LC11-2N Personal computer link module: LC02-0N Temperature controller: GREEN series Temperature controller: UT2000 series									
		GT09-C30R20202-15P	3m										
		GT09-C30R20203-9P	3m										
	GT09-C30R20204-14P	3m											
	GT09-C30R20205-25P	3m											
	GT09-C30R20301-9P	3m											
Cable for Yokogawa Electric PLC	GT09-C30R20302-9P	3m											
	GT09-C30R20305-9S	3m											
	GT09-C30R20304-9S	3m											
Cable for Allen-Bradley (Rockwell Automation, Inc.) PLC	GT09-C30R20701-9S	3m											
Cable for Siemens AG PLC	GT09-C30R20801-9S	3m											
Cable for OMRON PLC	GT09-C30R40101-9P	3m											
	GT09-C100R40101-9P	10m											
	GT09-C200R40101-9P	20m											
	GT09-C300R40101-9P	30m											
	GT09-C30R40102-9P	3m											
	GT09-C100R40102-9P	10m											
	GT09-C200R40102-9P	20m											
	GT09-C300R40102-9P	30m											
	GT09-C30R40103-5T	3m											
	GT09-C100R40103-5T	10m											
	GT09-C200R40103-5T	20m											
	GT09-C300R40103-5T	30m											
	GT09-C30R41101-5T	3m											
	GT09-C100R41101-5T	10m											
	GT09-C200R41101-5T	20m											
GT09-C300R41101-5T	30m												
Cable for Sharp Manufacturing Systems PLC	GT09-C30R40601-15P	3m											
	GT09-C100R40601-15P	10m											
	GT09-C200R40601-15P	20m											
	GT09-C300R40601-15P	30m											
	GT09-C30R40602-15P	3m											
	GT09-C100R40602-15P	10m											
Cable for JTEKT PLC	GT09-C200R41201-6C	20m											
	GT09-C300R41201-6C	30m											
	GT09-C30R40501-15P	3m											
	GT09-C100R40501-15P	10m											
	GT09-C200R40501-15P	20m											
	GT09-C300R40501-15P	30m											
Cable for TOSHIBA PLC	GT09-C30R40502-6C	3m											
	GT09-C100R40502-6C	10m											
	GT09-C200R40502-6C	20m											
	GT09-C300R40502-6C	30m											
	GT09-C30R40503-15P	3m											
	GT09-C100R40503-15P	10m											
Cable for Hitachi Industrial Equipment Systems PLC	GT09-C200R40503-15P	20m											
	GT09-C300R40503-15P	30m											
	GT09-C30R40401-7T	3m											
Cable for Hitachi PLC	GT09-C100R41301-9S	10m											
	GT09-C200R41301-9S	20m											
	GT09-C300R41301-9S	30m											
Cable for Fuji Electric FA Components & Systems PLC	GT09-C30R41001-6T	3m											
	GT09-C100R41001-6T	10m											
	GT09-C200R41001-6T	20m											
	GT09-C300R41001-6T	30m											
Cable for Yaskawa Electric PLC	GT09-C30R40201-9P	3m											
	GT09-C100R40201-9P	10m											
	GT09-C200R40201-9P	20m											
	GT09-C300R40201-9P	30m											
	GT09-C30R40202-14P	3m											
	GT09-C100R40202-14P	10m											
Cable for Yokogawa Electric PLC	GT09-C200R40301-6T	20m											
	GT09-C300R40301-6T	30m											
	GT09-C30R40302-6T	3m											
	GT09-C100R40302-6T	10m											
	GT09-C200R40302-6T	20m											
	GT09-C300R40302-6T	30m											
	GT09-C30R40303-6T	3m											
	GT09-C100R40303-6T	10m											
	GT09-C200R40303-6T	20m											
	GT09-C300R40303-6T	30m											
	GT09-C30R40304-6T	3m											
	GT09-C100R40304-6T	10m											

*1 : Items listed above are developed by Mitsubishi Electric System & Service Co., LTD., and sold through your local sales office.
 *2 : The applicable connection configuration and cable vary depending on the GOT main unit. For more details, see the GOT1000 Series Handbook and the GOT1000 Series Connection Manual.
 *3 : RS-422 cables less than 10m and the RS-232 cable less than 3m can be used when the connector conversion box for the Handy GOT is used.
 *4 : Can be used only with the GT105□ and GT104□.
 *5 : To connect with RS-422/485 interface of GT16 main unit, an RS-422 conversion cable (GT16-C02R4-9S) is necessary.

Notes for use

Backward compatibility

Project data

GT Designer/GT Designer2 → GT Works3 compatibility *
 Project data created in GT Designer2 can be used in GT Works3.
 Project data created in GT Designer can be used in GT Works3 after the data is converted by GT Designer2/GT Designer2 Classic.

GOT900 series → GOT1000 series compatibility *
Using data from the GOT-A900 series
 Project data for the GOT-A900 series can be used in the GOT1000 series.
 For the details, see Technical Bulletin No.GOT-A-0009 "Precautions when Replacing GOT-A900 Series with GOT1000 Series".

Using data from the GOT-F900 series
 Project data for the GOT-F900 series can be used in the GOT1000 series.
 For the details, see "Replacement Guidance (for GOT1000 Series) – From GOT-F900/A950 Handy Series to GOT1000 Series" (JY997D39301).

*Some data and functions cannot be used in the GOT1000 series.

Cables

- For details on using the GOT-A900 series bus connection cables, RS-422 cables and RS-232 cables with the GOT1000 series, see Technical Bulletin No.GOT-A-0009.
- For details regarding use of the GOT-F900 series RS-422 cable with the GOT1000, please contact your local sales office.
- The bus connection cables, RS-422 cables and RS-232 cables for the GOT1000 series cannot be used for the GOT900 series.
 (For details regarding use of bus connection cables in systems where both the GOT-A900 and GOT1000 series coexist, see Technical Bulletin No. GOT-A-0009.)

Panel cut dimensions

- GOT900 series → GOT1000 series compatibility**
- The A985GOT(-V) and GT1685/GT1585, A975/970GOT(-B) and GT167□/GT157□, F940GOT and GT1655/GT155□/GT145□/GT115□/GT105□ have the same panel dimensions, respectively. Therefore, it is not necessary to change the mounting hole size.
 - Although the A95□ differs in panel cut dimensions from the GT1655, GT155□, GT115□-Q□BDQ and GT115□-Q□BDA, the GOT900 series model can be replaced with any of the GOT1000 series ones without changing the mounting hole size.

Selection of optional units and devices

Using the optional functions listed in the table below may require optional devices or units as shown. Note that the availability of the function or the required optional units and devices may vary depending on the model of the GOT main unit.
 Functions not listed in the table below may also require a memory card or a USB memory device depending on the application. For details, see "Function list" (page 70 to page 73) and "GT Designer3 Version1 Screen Design Manual."
 An optional function board or a memory card may be necessary depending on the function version and hardware version of the GOT main unit or available space of the user area.
 For details, see "Optional function board, memory card (CF card, SD card), and USB memory selection <GT16/GT15/GT14/GT12/GT11>" (page 82 to page 83).
 - : Function that cannot be used on the model

Function	Required optional units and devices							
	GT16	GT16 Handy	GT15	GT14	GT12	GT11	GT10	
Memory extension	CF card	CF card	Optional function board: GT15-QFNB□M or GT15-MESB48M CF card	SD card	-	-	-	
Multi-channel function	Not necessary	Not necessary	Optional function board: GT15-QFNB□M or GT15-MESB48M	Not necessary	Not necessary	-	-	
Multimedia function*1	Multimedia unit: GT16M-MMR CF card for multimedia	-	-	-	-	-	-	
Video/RGB function	Video input*1 *2	-	Video input unit: GT15V-75V4 or Video/RGB input unit: GT15V-75V4R1	-	-	-	-	
	RGB input*1 *2	-	RGB input unit: GT15V-75R1 or Video/RGB input unit: GT15V-75V4R1	-	-	-	-	
	RGB output*1 *2	-	RGB output unit: GT15V-75ROUT	-	-	-	-	
CF card unit/CF card extension unit	CF card unit: GT15-CFCD or CF card extension unit: GT15-CFEX-C08SET	-	CF card unit: GT15-CFCD or CF card extension unit: GT15-CFEX-C08SET	-	-	-	-	
Sound output function	Sound output unit: GT15-SOUT	-	Sound output unit: GT15-SOUT	-	-	-	-	
Remote personal computer operation function (serial)*1 *2	RGB input unit: GT16M-R2 or Video/RGB input unit: GT16M-V4R1	-	RGB input unit: GT15V-75R1 or Video/RGB input unit: GT15V-75V4R1	-	-	-	-	
External input/output function, operation panel function	External input/output unit: GT15-DIO or GT15-DIOR	-	External input/output unit: GT15-DIO or GT15-DIOR	-	-	-	-	
File transfer function (FTP client)	USB memory device or CF card	USB memory or CF card	Ethernet communication unit: GT15-J71E-100 CF card	USB memory or SD card	-	-	-	
Gateway function	Not necessary	Not necessary	Ethernet communication unit: GT15-J71E71-100	Not necessary	Not necessary	-	-	
MES interface function	Optional function board: GT16-MESB	-	Ethernet communication unit: GT15-J71E71-100 Optional function board: GT15-MESB48M	-	-	-	-	
Document display function	CF card	CF card	Optional function board: GT15-QFNB□M or GT15-MESB48M CF card	-	-	-	-	
Operation log function	CF card	CF card	CF card	-	-	-	-	
Backup/restoration function	USB memory device or CF card	USB memory or CF card	CF card	USB memory or SD card	CF card	-	-	
Maintenance time notification function	Not necessary (equipped with battery as standard feature)	Not necessary (equipped with battery as standard feature)	Battery: GT15-BAT	-	-	-	-	
CNC data input/output function*3	USB memory device or CF card	-	CF card	-	-	-	-	
Ladder monitor function*4 (when using Q/L/QnA ladder monitor function)	Not necessary	Not necessary	Optional function board: GT15-QFNB□M or GT15-MESB48M	-	-	-	-	
SFC monitor function*4	CF card	CF card	Optional function board: GT15-QFNB□M or GT15-MESB48M CF card	-	-	-	-	
Motion SFC monitor function*4	CF card	CF card	Optional function board: GT15-QFNB□M or GT15-MESB48M CF card	-	-	-	-	
Ladder editor function*5	CF card	CF card	Optional function board: GT15-QFNB□M or GT15-MESB48M CF card	-	-	-	-	
Report function	Printer unit: GT15-PRN (when PictBridge-compatible printer is used) CF card	-	Printer unit: GT15-PRN (when PictBridge-compatible printer is used) CF card	-	-	-	-	
Hard copy function	Saving files on memory card	CF card	CF card	SD card*7	CF card	-	-	
	Printing by printer (serial)	Not necessary	-	Not necessary	-	-	Not necessary	
	Printing by printer (PictBridge)	Printer unit: GT15-PRN	-	Printer unit: GT15-PRN	-	-	-	

*1 : Excluding the GT16□□-VNB□ and GT1655.
 *2 : For the GT15, only the GT1585V and GT1575V are applicable. *6 : Including the GT11 Handy.
 *3 : Only XGA and SVGA of the GT16 and GT15 are applicable. *7 : Not necessary when the data storage drive is the built-in SRAM.
 *4 : Excluding QVGA of the GT155□.

INDEX
 For Designers
 For Initial Startup & Operations
 For Maintenance Personnel
 GT10
 IQ Platform
 MEL-SEC Process Control
 Specifications, External Dimensions
 List of Compatible Models, etc.

Notes for use

[Table A] Used capacity of extended functional OS and optional function OS

Function	User area size to be used (KB)					
	GT16/GT12	GT15	GT14	GT11		
Barcode*13	84	50	84	83	*1	
RFID*13	166	50	166	166	*1	
System monitor*13	692	450	746	691	*1	
Report	235	150	235	None	None	
Printer (PictBridge)	1104	552	1104	None	None	
Printer (serial)	200	80	200	200	None	
Device name conversion library*12 *14	800	400	800	800	None	
Stroke font	Stroke font support function	400	300	400	1300	400
	Stroke basic font (Japanese)	2160	2160	2160	2160	2160
	Stroke basic font (Japanese) (with Hangul)	3175	3175	3175	3175	3175
	Stroke basic font (Chinese: Simplified)	1474	1474	1474	1474	1474
	Stroke basic font (Chinese: Simplified) (with Hangul)	2016	2016	2016	2016	2016
Video display	480	298	512	None	None	
RGB display	480	298	512	None	None	
Video/RGB	480	298	512	None	None	
Multimedia	1074	292	None	None	None	
Remote personal computer operation (Ethernet)	5130	860	None	None	None	
Remote personal computer operation (serial)	480	292	512	None	None	
VNC* server	8192	512	None	None	None	
Backup/restoration*12 *13	766	420	820	766	766	
Operator authentication	730	460	784	None	None	
Operator authentication	730	460	784	None	None	
USB mouse/keyboard function	200	80	None	200	200	
Audio output	200	100	200	None	None	
External I/O, operation panel	100	70	100	None	None	
CNC data	383	210	437	None	None	
input/output	200	77	100	None	None	
Device data transfer	100	50	100	100	100	
MELSEC-L troubleshooting function	770	340	None	None	None	
SoftGOT-GOT link function	200	100	200	None	None	
Log viewer function	3882	1434	None	None	None	
File transfer function (FTP client)	1300	300	1300	1300	1300	
Maintenance time notification	*2	*2	*2	None	None	
Multi-channel*13	*2	*2	*2	*2	*2	
Chinese region	Standard font (Chinese: Simplified)	1280	1280	1280	1280	None
	Standard font (Chinese: Traditional)	1920	1920	1920	1920	None
	Standard font (Japanese)	1280	1280	1280	1280	None
	Stroke font (Japanese)	1037	1037	1037	1036	1036
	Stroke font (Chinese: Simplified)	1248	1248	1248	1248	1248
Stroke font (Chinese: Traditional)	1680	1680	1680	1680	1680	
Operation log*12	1221	384	1218	None	None	
Document display	3072	150	2048	None	None	
Kana-Kanji conversion	None	None	1223	None	None	
Kana-Kanji conversion (enhanced version)	2774	1242	2774	None	None	
Historical data list display*3 *13	*2	*2	*2	*2	*2	
Historical trend graph*3 *13	*2	*2	*2	*2	*2	
Logging*4 *13	710	380	740	710	710	
Recipe*13	100	70	100	100	100	
Advanced recipe	1187	310	1241	1024	1024	
Object script*4	360	180	360	360	360	
Ladder monitor	MELSEC-A ladder monitor	674	342	523	None	None
	MELSEC-FX ladder monitor	674	342	592	None	None
	MELSEC-Q/L/QnA ladder monitor	4170	590	1082	None	None
A list editor*13	1024	542	1058	1024	1024	
FX list editor*13	1024	542	1058	1024	1024	
Intelligent unit monitor	770	390	384	None	None	
Network monitor	370	210	324	None	None	

Function	User area size to be used (KB)				
	GT16/GT12	GT15	GT14	GT11	
Q motion monitor	770	390	607	None	None
Servo amplifier monitor	770	390	524	None	None
CNC monitor	770	390	588	None	None
SFC monitor	GOT platform library	200	77	100	None
	SFC monitor	2108	442	1373	None
Motion SFC monitor*10	GOT platform library	19381	4729	4729	None
	Motion SFC monitor	200	77	100	None
Ladder editor	GOT platform library	200	77	100	None
	Ladder editor	8192	2567	5121	None
Gateway	GOT function extension library	19381	4729	4729	None
	Gateway (server, client)	100	50	100	100
Gateway	Gateway (mail)	100	50	100	100
	Gateway (FTP server)*13	84	50	64	84
MES interface	13461	1598	3196	None	None

- *1: Requires installation of the optional function OS and extended function OS, but does not use the user area.
- *2: Installation of the optional function OS is not required.
- *3: It is necessary to specify the logging function and install the optional function OS (logging) in advance.
- *4: Necessary when using the GOT project data that is automatically created by PX Developer (Ver. 1.15 or later). For details, see "PX Developer Version 1 Operating Manual (GOT Screen Generator)(SH-080772ENG)."
- *5: To use the SFC monitor, free space of 6202KB or more is necessary in the user area of the specified drive for installing the extension function OS and optional function OS. The total capacity of the memory necessary for using the SFC monitor is 14393KB. Due to the above, the setting shown in Table 1 is necessary depending on the GOT to be used.

GOT	Necessary setting
GT157□-VN, GT1562-VN	Set boot source of OS to "A: standard CF card."
Other than above	Memory extension (install optional function board with expansion memory)

- *6: To use the ladder editor, free space of 9950KB or more is necessary in the user area of the specified drive for installing the extension function OS and optional function OS. The total capacity of the memory necessary for using the ladder editor is 21212KB. For the above reasons, when using the ladder editor, specify "A: Standard CF card" for the OS boot source, and mount an optional function board with a memory capacity of 16MB or more.
- *7: To use the SFC monitor, it is necessary to install all of the GOT platform library, SFC monitor and GOT function extension library.
- *8: To use the ladder editor, it is necessary to install all of the GOT platform library, ladder editor and GOT function extension library.
- *9: The operation of the MES interface function uses 8218KB of the extended memory (GT15-MESB48M(48MB)) of GT15's operation memory.
- *10: To use the motion SFC monitor, it is necessary to install all of the GOT platform library and motion SFC monitor.
- *11: To use the motion SFC monitor, free space of 2577KB or more is necessary in the user area of the specified drive for installing the extension function OS and optional function OS. The total capacity of the memory necessary for using the motion SFC monitor is 12622KB. For the above reasons, mount an optional function board with a memory capacity of 16MB or more.
- *12: The device name conversion library (extended function) is required when confirming the trigger device on the GOT using the backup/restoration function and when outputting the device name using the operation log function.
- *13: Function usable with the GT12.
- *14: The GT12 user usage area is as follows. RAM: 500KB, ROM: 250KB

[Table B] Capacity of communication driver

Units connected	Communication driver name	Capacity (KB)
Mitsubishi PLC, motion controller, robot controller, CNC	Bus connection Q	180
	A/QnA/L/QCPU, LJ71C24, QJ71C24	180
	MELSEC-FX	180
	MELSECNET/H	200
	CC-Link IE Controller Network	200
	CC-Link IE Field Network	230
Third party PLC, motion controller	JTEKT Corporation TOYOPUC-PC	160
	GE Fanuc Automation Corporation	180
	Ethernet (Yaskawa Electric Corporation)	160
Microcomputer	Ethernet (SIEMENS S7)	200
	Microcomputer connection, Ethernet (microcomputer)	230
Communication drivers other than above		150

- *3: The Ethernet connections include the following connection configurations.
 - Ethernet connection • MODBUS[®]/TCP connection • Third party PLC connection (Ethernet)
 - Robot controller connection (Ethernet) • CNC connection (Ethernet)
 - Microcomputer connection (Ethernet)

Maximum number of connectable channels, mountable units and mounting stages

- Number of connectable channels
The number of connectable channels varies depending on the GOT model. See Table C on the following page.
- Number of mountable units and mounting stages
When the multi-channel function is used, add interfaces to the GOT using any of the following methods.
 - Stack communication units on the extension interface.
 - Mount communication units on the extension interface to use the unit in combination with the standard interface. The number of mountable units and mounting stages vary depending on the GOT model. See Table C on the following page.

- *: The performance of GOT may be affected depending on the configuration of connected devices.
- *: Up to two channels can be connected to the GT12.
- *: No communication units can be mounted on the GT12.

Optional function board

Not necessary when using the GT16, GT14, and GT12.
The GT15 requires an optional function board. Use the optional function board GT15-QFNB(□M) or GT15-MESB48M. The GT15-FNB cannot be used.

Communication driver

A communication driver must be installed for each of the connection configurations. For the GT16 and GT14, the communication driver is installed in the user area. For the GT15, communication drivers for the second and subsequent channels will be installed in the user area. For the GT12, the communication driver is installed in the system area.

[Table C] Number of connectable channels, number of mountable units and number of mounting stages when the multi-channel function is used

	Function	User area size to be used (KB)					Description
		GT16/GT12	GT15	GT14	GT11		
(1)	Number of connectable channels	Up to 4 channels	Up to 2 channels	Up to 2 channels	Up to 4 channels	<GT16/GT15> The number of communication ports (communication units and interfaces) for use for communication on the GOT. • Only one channel per one GOT can be connected in the bus connection and network connection. • Ethernet connection is available for up to four channels. (GT16 only) • When the Ethernet interface built into the GOT (GT16) or the Ethernet communication unit (GT15) is used for functions other than communication with the connected device*4, the interface is not included in the number of connected channels. • The number of channels does not include the interface used for connection with external devices. *5	
		<GT14/GT12> The number of communication ports (communication interfaces) for use for communication on the GOT. • Ethernet connection is available for up to two channels. (GT1455-QTBE, GT1450-QLBDE only) • When the Ethernet interface built into the GOT is used for functions other than communication with the connected device*4, the interface is not included in the number of connected channels. • The number of channels does not include the interface used for connection with external devices. *5					
(2)	Number of mounting stages	Up to 5 units (2 slots)	Up to 3 units (1 slot)	Up to 5 units (2 slots)	Up to 3 units (1 slot)	No units can be mounted	The number of units that can be mounted on extension interfaces 1 and 2 of the GOT. • More than one serial communication unit *9 of the same model can be mounted. • Optional units are included in the number of units. • RS-422 conversion units are not included in the number of units. (The RS-422 conversion unit cannot be used with GT1655 and GT155□.) • It is necessary to calculate the total current consumed by the units to be mounted.
		Up to 3 stages (2 slots)	Up to 3 stages (1 slot)	Up to 3 stages (2 slots)	Up to 3 stages (1 slot)	No units can be mounted	See "External dimensions" (page 61) and "Mounting units on the GOT side interface <GT16/GT15>" (page 85). • Units that occupy two slots *7 *8 must be mounted on the first stage. • When any units in *8 are used, mount the unit on the first stage, then mount other units on the second or subsequent stages. • Units in *9 cannot be stacked on other units. Mount units on the first stage.

- *4: Ethernet download function, gateway function, MES interface function, file transfer function (FTP client), remote personal computer function (Ethernet)
- *5: Barcode reader, RFID controller, personal computer (remote personal computer function [serial]), FA transparent function, OS write, and project data write, and printer (serial)
- *6: GT15-RS2-9P, GT15-RS4-9S and GT15-RS4-TE
- *7: GT15-QBUS2, GT15-ABUS2, GT15-J71LP23-25, GT15-J71BR13, GT15-J61BT13, GT15-J71GP23-SX
- *8: GT16M-V4, GT15V-75V4, GT16M-R2, GT15V-75R1, GT16M-V4R1, GT15V-75V4R1, GT16M-ROUT, GT15V-75ROUT, GT16M-MMR
- *9: GT15-75QBUSL, GT15-75QBUS2L, GT15-75ABUSL, GT15-75ABUS2L, GT15-75J71LP23-Z, GT15-75J71BR13-Z, GT15-75J61BT13-Z

Mounting units on the GOT interface <GT16/GT15>

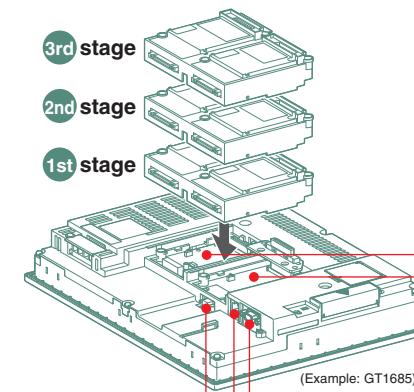

Extension interface 1 (On GT16 Handy, no units can be mounted because it does not have extension interface 1 or 2.)

Extension interface 2 (GT1655 and GT155□ has the extension interface 1 only)

Up to 3 communication units and optional units can be mounted on each extension interface.

Mount a unit that occupies two slots on the first stage. However, when any of the following units are used, mount the unit on the first stage, then mount other units on the second and subsequent stages.

For GT16 (Only one of these units can be mounted on the GT16 except GT16□-VNB□ and GT1655)

- GT16M-V4, GT16M-R2, GT16-V4R1, GT16-ROUT, GT16M-MMR

For GT15 (Only one of these units can be mounted on the GT1585V and GT1575V)

- GT15V-75V4, GT15V-75R1, GT15V-75V4R1, GT15V-75ROUT

The following units must not be stacked on other units. Mount any of them on the first stage.

- GT15-75QBUSL, GT15-75QBUS2L, GT15-75ABUSL, GT15-75ABUS2L
- GT15-75J71LP23-Z, GT15-75J71BR13-Z, GT15-75J61BT13-Z (GT16 or GT155□ cannot be used.)

Instructions for mounting and removing the GT15-CFCD

- An extension unit cannot be mounted on a CF card unit. When extension units are mounted, mount the CF card unit on the last stage.
- When mounting a CF card unit on extension interface 1 (left), ensure that the number of extension units mounted on extension interface 2 (right) is smaller than the number on the extension interface 1 (left). Otherwise, the CF card cannot be inserted or removed.
- Remove the CF card unit in the designated direction (ΔPULL) to prevent damage to the connector.

Standard interface (built-in RS-232 interface)

The interface can establish a serial connection with connected devices and peripheral devices, such as a barcode reader.

Standard interface (built-in Ethernet interface) (GT16 only)

The interface can establish a connection with connected devices via Ethernet.

Standard interface (built-in RS-422/485 interface) (GT16 only)

The interface can establish a serial connection with connected devices.

Unit occupying two slots
Ex.: GT15-QBUS2

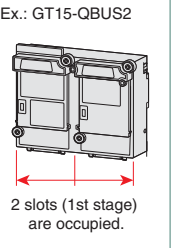

To use the multi-channel function <GT16/GT15/GT14/GT12>

The multi-channel function is designed to connect and monitor multiple FA devices by mounting multiple communication units on a single GOT unit or by using the standard interface.

Acceptable combinations

The following connection combinations can be used for the multi-channel function.

When using GT16:

- Bus connection or network connection *1 + serial connection *2
- Bus connection or network connection *1 + Ethernet connection *3
- Ethernet connection *3 + serial connection *2
- Bus connection or network connection *1 + Ethernet connection *3 + serial connection *2
- Serial connection *2
- Ethernet connection *3

* GT16 Handy can be connected only by methods ③ or ⑥.

When using GT15:

- Bus connection, network connection *1, or Ethernet connection *3 + serial connection *2
- Serial connection *2

When using GT14:

- Ethernet connection *3 + serial connection *2
- Serial connection *2

When using GT12:

- Ethernet connection *3 + serial connection *2
- Serial connection *2

*1: The network connections include the following connection configurations.

- MELSECNET/H connection • MELSECNET/10 connection
- CC-Link IE Controller Network connection • CC-Link IE Field Network connection
- CC-Link connection (ID)

*2: The serial connections include the following connection configurations.

- CPU direct connection • Computer link connection • CC-Link connection (via G4)
- Microcomputer connection (serial) • Connection with third party PLCs (serial)
- Temperature controller connection • Inverter connection • Servo amplifier connection
- CNC connection (CPU direct connection) • GOT multi-drop connection
- MODBUS[®]/RTU connection • Robot controller connection (serial)

Calculation of current consumed by units <GT16/GT15>

When using multiple units, a barcode reader, and a RFID controller, the total current consumed by the units, barcode reader and RFID controller must be less than the current that can be supplied by the GOT. Design the system using the following values so that the total current is within the range of the current supply capacity of the GOT.

(1) Current that can be supplied by the GOT

GOT model	Current supply capacity (A)
GT1695	2.4
GT1685	2.4
GT167□	2.4
GT166□	2.4
GT1655	1.3
GT1595	2.13
GT1585	1.74
(incl. GT1585V)	
GT157□	2.2
(incl. GT1575V)	
GT156□	2.2
GT155□	1.3

(2) Current used by units, barcode reader and RFID controller

Unit model	Consumed current (A)	Unit model	Consumed current (A)
GT15-QBUS GT15-QBUS2 GT15-75QBUSL GT15-75QBUS2L	0.275*1	Barcode reader	*2
		GT15-PRN	0.09
		GT16M-V4	0.12 *1
		GT15V-75V4	0.2 *1
GT15-ABUS GT15-ABUS2 GT15-75ABUSL GT15-75ABUS2L	0.12	GT16M-R2	0 *1
		GT15V-75R1	0.2 *1
		GT16M-V4R1	0.12 *1
		GT15V-75V4R1	0.2 *1
GT15-RS2-9P GT15-RS4-9S GT15-RS4-TE	0.29 0.33 0.3	GT16M-ROUT	0.11 *1
		GT15V-75ROUT	0.11
		GT16M-MMR	0.27 *1
		GT15-CFCD	0.07
GT15-RS2T4-9P GT15-J71E71-100 GT15-J71GP23-SX GT15-J71GF13-T2 GT15-J71LP23-25 GT15-J71BR13 GT15-J6			

MELSOFT GT Works3 (English version) operating environment

Item	Description																																						
Personal computer	PC/AT compatible machine on which the following OS operates																																						
OS (English, Simplified Chinese, Traditional Chinese, Korean, German versions)	Microsoft® Windows® 7 (64bit/32bit) (Enterprise, Ultimate, Professional, Home Premium, Starter) Microsoft® Windows Vista® (32bit) (Enterprise, Ultimate, Business, Home Premium, Home Basic) Microsoft® Windows® XP Service Pack2 or later (32bit) (Professional, Home Edition) Microsoft® Windows® 2000 Professional Service Pack4																																						
CPU	1GHz or more recommended																																						
Required memory	Microsoft® Windows® 7, Microsoft® Windows Vista®: 1GB or more recommended Microsoft® Windows® XP, Microsoft® Windows® 2000: 512MB or more recommended																																						
Display	Resolution XGA (1024 x 768 dots) or more																																						
Available hard disk space	To install GT Designer3: 2GB or more recommended To run GT Designer3: 512MB or more recommended																																						
Display colors	High Color (16 bits) or more																																						
Software	Simulation on a PC requires the following software: ●GX Works2 version 1.12N or later*1 or GX Simulator version 5.00A or later *1. * The applicable software version of GX Works2 or GX Simulator varies depending on the PLC CPU to be simulated.																																						
	<table border="1"> <thead> <tr> <th>PLC CPU to be simulated</th> <th>GX Simulator version</th> <th>GX Works2 version</th> </tr> </thead> <tbody> <tr> <td>QCPU (A mode), ACPU, motion controller CPU (A series)</td> <td>5.00A or later</td> <td>—</td> </tr> <tr> <td>QnACPU</td> <td rowspan="2">5.40E or later</td> <td rowspan="2">1.24A or later</td> </tr> <tr> <td>FX₀ series, FX_{0N} series, FX_{0S} series, FX₁ series, FX_{1N} series, FX_{1NC} series, FX_{1S} series, FX₂ series, FX_{2C} series, FX_{2N} series, FX_{2NC} series</td> </tr> <tr> <td>QCPU (Q mode) (except Q00J/Q00/Q01CPU)</td> <td rowspan="2">6.00A or later</td> <td rowspan="2">1.12N or later</td> </tr> <tr> <td>Q00JCPU, Q00CPU, Q01CPU</td> </tr> <tr> <td>Q02PHCPU, Q06PHCPU</td> <td>7.20W or later</td> <td rowspan="4">—</td> </tr> <tr> <td>Q12PHCPU, Q25PHCPU</td> <td>6.10L or later</td> </tr> <tr> <td>Q12PRHCPU, Q25PRHCPU</td> <td>6.20W or later</td> </tr> <tr> <td>FX_{3UC} series, FX_{3U} series*2</td> <td>7.08J or later</td> </tr> <tr> <td>FX_{3G} series*2</td> <td>7.22Y or later</td> <td>1.24A or later</td> </tr> <tr> <td>FX_{3GC} series*2</td> <td>—</td> <td>1.77F or later</td> </tr> <tr> <td>Q00UJCPU, Q00UCPU, Q01UCPU, Q02UCPU, Q03UDCPU, Q04UDHCPU, Q06UDHCPU, Q10UDHCPU, Q13UDHCPU, Q20UDHCPU, Q26UDHCPU, Q03UDECPU, Q04UDEHCPU, Q06UDEHCPU, Q10UDEHCPU, Q13UDEHCPU, Q20UDEHCPU, Q26UDEHCPU</td> <td>7.23Z or later</td> <td>1.12N or later</td> </tr> <tr> <td>LCPU</td> <td>—</td> <td>1.24A or later</td> </tr> <tr> <td>Q50UDEHCPU, Q100UDEHCPU</td> <td>—</td> <td>1.30G or later</td> </tr> </tbody> </table>	PLC CPU to be simulated	GX Simulator version	GX Works2 version	QCPU (A mode), ACPU, motion controller CPU (A series)	5.00A or later	—	QnACPU	5.40E or later	1.24A or later	FX ₀ series, FX _{0N} series, FX _{0S} series, FX ₁ series, FX _{1N} series, FX _{1NC} series, FX _{1S} series, FX ₂ series, FX _{2C} series, FX _{2N} series, FX _{2NC} series	QCPU (Q mode) (except Q00J/Q00/Q01CPU)	6.00A or later	1.12N or later	Q00JCPU, Q00CPU, Q01CPU	Q02PHCPU, Q06PHCPU	7.20W or later	—	Q12PHCPU, Q25PHCPU	6.10L or later	Q12PRHCPU, Q25PRHCPU	6.20W or later	FX _{3UC} series, FX _{3U} series*2	7.08J or later	FX _{3G} series*2	7.22Y or later	1.24A or later	FX _{3GC} series*2	—	1.77F or later	Q00UJCPU, Q00UCPU, Q01UCPU, Q02UCPU, Q03UDCPU, Q04UDHCPU, Q06UDHCPU, Q10UDHCPU, Q13UDHCPU, Q20UDHCPU, Q26UDHCPU, Q03UDECPU, Q04UDEHCPU, Q06UDEHCPU, Q10UDEHCPU, Q13UDEHCPU, Q20UDEHCPU, Q26UDEHCPU	7.23Z or later	1.12N or later	LCPU	—	1.24A or later	Q50UDEHCPU, Q100UDEHCPU	—	1.30G or later
PLC CPU to be simulated	GX Simulator version	GX Works2 version																																					
QCPU (A mode), ACPU, motion controller CPU (A series)	5.00A or later	—																																					
QnACPU	5.40E or later	1.24A or later																																					
FX ₀ series, FX _{0N} series, FX _{0S} series, FX ₁ series, FX _{1N} series, FX _{1NC} series, FX _{1S} series, FX ₂ series, FX _{2C} series, FX _{2N} series, FX _{2NC} series																																							
QCPU (Q mode) (except Q00J/Q00/Q01CPU)	6.00A or later	1.12N or later																																					
Q00JCPU, Q00CPU, Q01CPU																																							
Q02PHCPU, Q06PHCPU	7.20W or later	—																																					
Q12PHCPU, Q25PHCPU	6.10L or later																																						
Q12PRHCPU, Q25PRHCPU	6.20W or later																																						
FX _{3UC} series, FX _{3U} series*2	7.08J or later																																						
FX _{3G} series*2	7.22Y or later	1.24A or later																																					
FX _{3GC} series*2	—	1.77F or later																																					
Q00UJCPU, Q00UCPU, Q01UCPU, Q02UCPU, Q03UDCPU, Q04UDHCPU, Q06UDHCPU, Q10UDHCPU, Q13UDHCPU, Q20UDHCPU, Q26UDHCPU, Q03UDECPU, Q04UDEHCPU, Q06UDEHCPU, Q10UDEHCPU, Q13UDEHCPU, Q20UDEHCPU, Q26UDEHCPU	7.23Z or later	1.12N or later																																					
LCPU	—	1.24A or later																																					
Q50UDEHCPU, Q100UDEHCPU	—	1.30G or later																																					
Others	Mouse, keyboard, printer, CD-ROM drive (for installation only), sound function (sound card)*3, speaker*3 used with the above OS																																						
Applicable GOT	GOT1000 series																																						
Applicable software version	GT Works3 Version 1.54G or later																																						

*1 : Use GT Simulator3, GX Developer, GX Simulator, and GX Works2 of the same language version.
*2 : The GOT-A900 cannot be simulated.
*3 : May be required when the simulation function is used.

[Cautions]
•The software installation and the GOT-A900 simulation require administrator authority.
•Using GT Works3 application requires an account with higher privileges than the standard user in Windows® 7 and Windows Vista®.
•To use GT Works3 alongside another application in Windows® 7 and Windows Vista®, use an administrator account to run it if an administrator account is used to run the other application.
•The following functions are not supported in Windows® 7, Windows Vista®, or Windows® XP.
Running Applications in Windows® Compatibility Mode, Fast User Switching, Desktop Theme (Font Size) Change, Remote Desktop, DPI Setting other than 100%.
•Windows XP Mode, Windows Touch features are not supported in Windows® 7.

GT SoftGOT1000 Version3 (English version) operating environment

Item	Description	
	With DOS/V personal computer	With PC CPU module
Personal computer	PC/AT compatible machine on which the following OS operates	CONTEC PC CPU unit (PPC-852-212, PPC-852-217, PPC-852-226) *3
OS (English, Simplified Chinese, Traditional Chinese, Korean, German versions)	Microsoft® Windows® 7 (64bit/32bit) (Enterprise, Ultimate, Professional, Home Premium, Starter) Microsoft® Windows Vista® (32bit) (Enterprise, Ultimate, Business, Home Premium, Home Basic) Microsoft® Windows® XP Service Pack2 or later (32bit) (Professional, Home Edition, Embedded *4) Microsoft® Windows® 2000 Professional Service Pack4	
CPU	1GHz or more recommended	
Required memory	Microsoft® Windows® 7, Microsoft® Windows Vista®: 1GB or more recommended Microsoft® Windows® XP, Microsoft® Windows® 2000: 512MB or more recommended	
Display	Resolution VGA (640 x 480 dots) or more	
Available hard disk space*1	For installation: 2GB or more recommended For execution: 512MB or more recommended	
Display colors	High Color (16 bits) or more	
Hardware*2	GT15-SGTKEY-U (License key (for USB port)) GT15-SGTKEY-P (License key (for parallel port))	GT15-SGTKEY-U (License key (for USB port))
Software	When creating or editing project data : GT Designer3 *5 When using with PX Developer : PX Developer Version 1.14Q or later (PX Developer Version 1.31H or later when using the security level change)	
Others	Mouse, keyboard, printer, CD-ROM drive (for installation only), sound function (sound card), speaker used with the above OS	

*1 : Use of GT Designer3 and PX Developer requires additional memory space. For free space required when using the PX Developer monitoring tool, refer to the PX Developer Version1 Operation Manual (Monitor Tool). Additional memory space is also required when using user-created applications.
*2 : The PC must be equipped with a USB port to use the GT15-SGTKEY-U.
The PC must be equipped with a parallel port (Centro/printer connector) to use the GT15-SGTKEY-P.
*3 : For CONTEC PC CPU unit, refer to the manual for the PC CPU module.
*4 : Use is possible only when PPC-852-226 is preinstalled.
*5 : GT Designer3 and GT SoftGOT1000 must be installed from the same GT Works3 suite.

[Cautions]
•The software installation and the GOT-A900 simulation require administrator authority.
•Using GT Works3 application requires an account with higher privileges than the standard user in Windows® 7 and Windows Vista®.
•To use GT Works3 alongside another application in Windows® 7 and Windows Vista®, use an administrator account to run it if an administrator account is used to run the other application.
•The following functions are not supported in Windows® 7, Windows Vista®, or Windows® XP.
Running Applications in Windows® Compatibility Mode, Fast User Switching, Desktop Theme (Font Size) Change, Remote Desktop, DPI Setting other than 100%.
•Windows XP Mode, Windows Touch features are not supported in Windows® 7.

Please confirm the following product warranty details before using this product.

Gratis Warranty Term and Gratis Warranty Range

If any faults or defects (hereinafter "Failure") found to be the responsibility of Mitsubishi occurs during use of the product within the gratis warranty term, the product shall be repaired at no cost via the sales representative or Mitsubishi Service Company. However, if repairs are required onsite at domestic or overseas location, expenses to send an engineer will be solely at the customer's discretion. Mitsubishi shall not be held responsible for any re-commissioning, maintenance, or testing on-site that involves replacement of the failed module.

Gratis Warranty Term

The gratis warranty term of the product shall be for thirty-six (36) months after the date of purchase or delivery to a designated place.

Note that after manufacture and shipment from Mitsubishi, the maximum distribution period shall be six (6) months, and the longest gratis warranty term after manufacturing shall be forty-two (42) months. The gratis warranty term of repair parts shall not exceed the gratis warranty term before repairs.

Gratis Warranty Range

- The customer shall be responsible for the primary failure diagnosis unless otherwise specified. If requested by the customer, Mitsubishi Electric Corporation or its representative firm may carry out the primary failure diagnosis at the customer's expense. The primary failure diagnosis will, however, be free of charge should the cause of failure be attributable to Mitsubishi Electric Corporation.
- The range shall be limited to normal use within the usage state, usage methods, usage environment, etc. which follow the conditions, precautions, etc. given in the instruction manual, user's manual, caution labels on the product, etc.
- Even within the gratis warranty term, repairs shall be charged for in the following cases.
 - Failure occurring from inappropriate storage or handling, carelessness or negligence by the user. Failure caused by the user's hardware or software design.
 - Failure caused by unapproved modifications, etc., to the product by the user.
 - When the Mitsubishi product is assembled into a user's device, Failure that could have been avoided if functions or structures, judged as necessary in the legal safety measures the user's device is subject to or as necessary by industry standards, had been provided.
 - Failure that could have been avoided if consumable parts designated in the user's manual etc. had been correctly serviced or replaced.
 - Replacing consumable parts such as the battery, backlight and fuses.
 - Failure caused by external irresistible forces such as fires or abnormal voltages, and Failure caused by force majeure such as earthquakes, lightning, wind and water damage.
 - Failure caused by reasons unpredictable by scientific technology standards at time of shipment from Mitsubishi.
 - Any other failure found not to be the responsibility of Mitsubishi or that admitted not to be so by the user.

Onerous repair term after discontinuation of production

- Mitsubishi shall accept onerous product repairs for seven (7) years after production of the product is discontinued. Discontinuation of production shall be notified with Mitsubishi Technical Bulletins, etc.
- Product supply (including repair parts) is not available after production is discontinued.

Overseas service

Overseas, repairs shall be accepted by Mitsubishi's local overseas FA Center. Note that the repair conditions at each FA Center may differ.

Exclusion of loss in opportunity and secondary loss from warranty liability

Regardless of the gratis warranty term, Mitsubishi shall not be liable for compensation to damages caused by any cause found not to be the responsibility of Mitsubishi, loss in opportunity, lost profits incurred to the user by Failures of Mitsubishi products, special damages and secondary damages whether foreseeable or not, compensation for accidents, and compensation for damages to products other than Mitsubishi products, replacement by the user, maintenance of on-site equipment, start-up test run and other tasks.

Changes in product specifications

The specifications given in the catalogs, manuals or technical documents are subject to change without prior notice.

Product application

- In using the Mitsubishi graphic operation terminal, the usage conditions shall be that the application will not lead to a major accident even if any problem or fault should occur in the graphic operation terminal device, and that backup and fail-safe functions are systematically provided outside of the device for any problem or fault.
- The Mitsubishi graphic operation terminal has been designed and manufactured for applications in general industries, etc. Thus, applications in which the public could be affected such as in nuclear power plants and other power plants operated by respective power companies, and applications in which a special quality assurance system is required, such as for Railway companies or Public service purposes shall be excluded from the graphic operation terminal applications. In addition, applications in which human life or property that could be greatly affected, such as in aircraft, medical applications, incineration and fuel devices, manned transportation equipment for recreation and amusement, and safety devices, shall also be excluded from the graphic operation terminal range of applications. However, in certain cases, some applications may be possible, providing the user consults the local Mitsubishi representative outlining the special requirements of the project, and providing that all parties concerned agree to the special circumstances, solely at our discretion. In some of these cases, however, Mitsubishi Electric Corporation may consider the possibility of an application, provided that the customer notifies Mitsubishi Electric Corporation of the intention, the application is clearly defined and any special quality is not required.

Specification

Item	Description
Resolution (dots)	640 x 480, 800 x 600, 1024 x 768, 1280 x 1024, 1600 x 1200 Specifiable resolution (640 to 1920 x 480 to 1200)
Display colors	65,536 colors
Memory capacity	57MB
Connection configuration*1	Bus connection*2, CPU direct connection, Computer link connection, CC-Link IE Controller Network connection, CC-Link IE Field Network connection, MELSECNET connection, Ethernet connection

*1 : The required devices vary depending on the connection configuration.
*2 : Connectable only when using a PC CPU unit.

MEMO

Lined area for writing on page 90.

MEMO

Lined area for writing on page 91.

GOT is a registered trademark of Mitsubishi Electric Corporation.
 Microsoft®, Windows®, Windows NT®, Windows Server®, Windows Vista®, and Windows® 7 are registered trademarks or trademarks of Microsoft Corporation in the United States and other countries.
 Adobe® and Adobe® Reader® are registered trademarks of Adobe Systems Incorporated.
 Pentium® and Celeron® are registered trademarks of Intel Corporation in the United States and other countries.
 Ethernet is a registered trademark of Xerox Corporation in the United States.
 MODBUS® is a trademark of Schneider Electric SA.
 VNC® is a registered trademark of RealVNC Ltd. in the United States and other countries.
 Other company and product names herein are either trademarks or registered trademarks of their respective owners.

Mitsubishi Electric Corporation Nagoya Works and Himeji Works are factories certified for ISO14001 (standards for environmental management systems) and ISO9001 (standards for quality assurance management systems).



Mitsubishi Graphic Operation Terminal

Precautions for Choosing the Products

This catalog explains the typical features and functions of the GOT1000 series HMI and does not provide restrictions and other information on usage and module combinations.

When using the products, always read the user's manuals of the products.

Mitsubishi will not be held liable for damage caused by factors found not to be the cause of Mitsubishi; machine damage or lost profits caused by faults in the Mitsubishi products; damage, secondary damage, accident compensation caused by special factors unpredictable by Mitsubishi; damages to products other than Mitsubishi products; and to other duties.

For safe use

- To use the products given in this catalog properly, always read the related manuals before starting to use them.
- The products within this catalog have been manufactured as general-purpose parts for general industries and have not been designed or manufactured to be incorporated into any devices or systems used in purpose related to human life.
- Before using any product for special purposes such as nuclear power, electric power, aerospace, medicine or passenger movement vehicles, consult with Mitsubishi.
- The products within this catalog have been manufactured under strict quality control. However, when installing the product where major accidents or losses could occur if the product fails, install appropriate backup or failsafe functions in the system.

Country/Region	Sales office	Tel/Fax
USA	MITSUBISHI ELECTRIC AUTOMATION, INC. 500 Corporate Woods Parkway, Vernon Hills, IL 60061, U.S.A.	Tel: +1-847-478-2100 Fax: +1-847-478-2253
Brazil	MELCO-TEC Representacao Comercial e Assessoria Tecnica Ltda. Av. Paulista, 1439, cj74, Bela Vista, Sao Paulo CEP: 01311-200 - SP Brazil	Tel: +55-11-3146-2200 Fax: +55-11-3146-2217
Germany	MITSUBISHI ELECTRIC EUROPE B.V. German Branch Gothaer Strasse 8, D-40880 Ratingen, Germany	Tel: +49-2102-486-0 Fax: +49-2102-486-1120
UK	MITSUBISHI ELECTRIC EUROPE B.V. UK Branch Travellers Lane, Hatfield, Hertfordshire, AL10 8XB, U.K.	Tel: +44-1707-28-8780 Fax: +44-1707-27-8695
Italy	MITSUBISHI ELECTRIC EUROPE B.V. Italian Branch VIALE COLLEONI 7 - 20864 Agrate Brianza (Milano), Italy	Tel: +39-039-60531 Fax: +39-039-6053-312
Spain	MITSUBISHI ELECTRIC EUROPE B.V. Spanish Branch Carretera de Rubí 76-80-AC.420, E-08190 Sant Cugat del Vallés (Barcelona), Spain	Tel: +34-935-65-3131 Fax: +34-935-89-1579
France	MITSUBISHI ELECTRIC EUROPE B.V. French Branch 25, Boulevard des Bouvets, F-92741 Nanterre Cedex, France	Tel: +33-1-55-68-55-68 Fax: +33-1-55-68-57-57
Czech Republic	MITSUBISHI ELECTRIC EUROPE B.V. -o.s. Czech Office Avenir Business Park, Radicka 751/113e, 158 00 Praha 5, Czech Republic	Tel: +420-251-551-470 Fax: +420-251-551-471
Poland	MITSUBISHI ELECTRIC EUROPE B.V. Polish Branch 32-083 Balice ul. Krakowska 50, Poland	Tel: +48-12-630-47-00 Fax: +48-12-630-47-01
Russia	MITSUBISHI ELECTRIC EUROPE B.V. Russian Branch Moscow Office 52, bld. 3, Kosmodamianskaya nab., RU-115054, Moscow, Russia	Tel: +7-495-721-2070 Fax: +7-495-721-2071
South Africa	ADROIT TECHNOLOGIES 20 Waterford Office Park, 189 Witkoppen Road, ZA-Fourways, South Africa	Tel: +27-11-658-8100 Fax: +27-11-658-8101
China	MITSUBISHI ELECTRIC AUTOMATION (CHINA) LTD. No.1386 Hongqiao Road, Mitsubishi Electric Automation Center, Changning District, Shanghai, China	Tel: +86-21-2322-3030 Fax: +86-21-2322-3000
Taiwan	SETSUYO ENTERPRISE CO., LTD. 6F., No.105, Wugong 3rd Road, Wugu District, New Taipei City 24889, Taiwan, R.O.C.	Tel: +886-2-2299-2499 Fax: +886-2-2299-2509
Korea	MITSUBISHI ELECTRIC AUTOMATION KOREA CO., LTD. (Sales) 3F, 1480-6, Gayang-Dong, Gangseo-Gu, Seoul 157-200, Korea	Tel: +82-2-3660-9530 Fax: +82-2-3664-8372 +82-2-3664-8335
Singapore	MITSUBISHI ELECTRIC ASIA PTE. LTD -Industrial Division 307 Alexandra Road, Mitsubishi Electric Building, Singapore 159943	Tel: +65-6473-2308 Fax: +65-6476-7439
Thailand	MITSUBISHI ELECTRIC AUTOMATION (THAILAND) CO., LTD. Bang-Chan Industrial Estate No.111 Soi Serithai 54, T.Kannayao, A.Kannayao, Bangkok 10230, Thailand	Tel: +66-2906-3238 Fax: +66-2906-3239
Indonesia	P.T. Autoteknindo Sumber Makmur Muara Karang Selatan, Block A / Utara No.1 Kav. No.11, Kawasan Industri Pergudangan, Jakarta- Utara 14440, P.O. Box 5045, Indonesia	Tel: +62-21-663-0833 Fax: +62-21-663-0832
India	MITSUBISHI ELECTRIC INDIA PVT. LTD. Emerald House, EL-3, J Block, M.I.D.C., Bhosari, Pune, 411026, Maharashtra State, India	Tel: +91-20-2710-2000 Fax: +91-20-2710-2100
Australia	MITSUBISHI ELECTRIC AUSTRALIA PTY. LTD. 348 Victoria Road, P.O. Box 11, Rydalmere, N.S.W. 2116, Australia	Tel: +61-2-9684-7777 Fax: +61-2-9684-7245

MITSUBISHI ELECTRIC CORPORATION

HEAD OFFICE: TOKYO BLDG., 2-7-3, MARUNOUCHI, CHIYODA-KU, TOKYO 100-8310, JAPAN
NAGOYA WORKS: 1-14, YADA-MINAMI 5, HIGASHI-KU, NAGOYA, JAPAN

When exported from Japan, this manual does not require application to the Ministry of International Trade and Industry for service transaction permission.